

CD4030B Types

CMOS Quad Exclusive-OR Gate

High-Voltage Types (20-Volt Rating)

■ CD4030B types consist of four independent Exclusive-OR gates. The CD4030B provides the system designer with a means for direct implementation of the Exclusive-OR function.

The CD4030B types are supplied in 14-lead hermetic dual-in-line ceramic packages (F3A suffix), 14-lead dual-in-line plastic packages (E suffix), 14-lead small-outline packages (M, MT, M96, and NSR suffixes), and 14-lead thin shrink small-outline packages (PW and PWR suffixes).

MAXIMUM RATINGS, Absolute-Maximum Values:

DC SUPPLY-VOLTAGE RANGE, (V_{DD})

Voltages referenced to V_{SS} Terminal -0.5V to +20V

INPUT VOLTAGE RANGE, ALL INPUTS -0.5V to V_{DD} +0.5V

DC INPUT CURRENT, ANY ONE INPUT ± 10 mA

POWER DISSIPATION PER PACKAGE (P_D):

For $T_A = -55^\circ\text{C}$ to $+100^\circ\text{C}$ 500mW

For $T_A = +100^\circ\text{C}$ to $+125^\circ\text{C}$ Derate Linearly at 12mW/ $^\circ\text{C}$ to 200mW

DEVICE DISSIPATION PER OUTPUT TRANSISTOR

FOR $T_A = \text{FULL PACKAGE-TEMPERATURE RANGE (All Package-Types)}$ 100mW

OPERATING-TEMPERATURE RANGE (T_A) -55°C to $+125^\circ\text{C}$

STORAGE TEMPERATURE RANGE (T_{stg}) -65°C to $+150^\circ\text{C}$

LEAD TEMPERATURE (DURING SOLDERING):

At distance $1/16 \pm 1/32$ inch (1.59 ± 0.79 mm) from case for 10s max $+265^\circ\text{C}$

Features:

- Medium-speed operation— t_{pHL} , $t_{pLH} = 65$ ns (typ.) at $V_{DD} = 10$ V, $C_L = 50$ pF
- 100% tested for quiescent current at 20 V
- Standardized, symmetrical output characteristics
- 5-V, 10-V, and 15-V parametric ratings
- Maximum input current of $1 \mu\text{A}$ at 18 V over full package-temperature range; 100 nA at 18 V and 25°C
- Noise margin (over full package-temperature range):

1 V at $V_{DD} = 5$ V

2 V at $V_{DD} = 10$ V

2.5 V at $V_{DD} = 15$ V

- Meets all requirements of JEDEC Tentative Standard No. 13B, "Standard Specifications for Description of 'B' Series CMOS Devices"

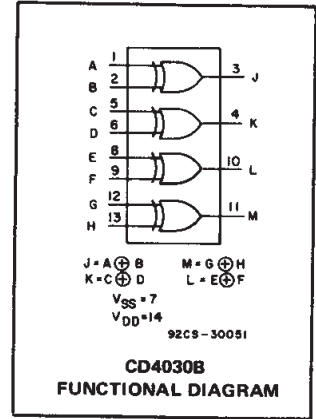

CD4030B
FUNCTIONAL DIAGRAM

Applications:

- Even and odd-parity generators and checkers
- Logical comparators
- Adders/subtractors
- General logic functions

TERMINAL DIAGRAM Top View

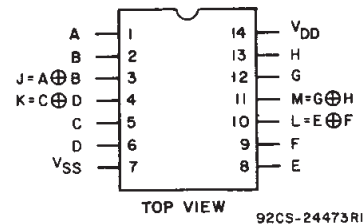

RECOMMENDED OPERATING CONDITIONS

For maximum reliability, nominal operating conditions should be selected so that operation is always within the following ranges:

CHARACTERISTIC	LIMITS		UNITS
	MIN.	MAX.	
Supply-Voltage Range (For $T_A = \text{Full Package Temperature Range}$)	3	18	V

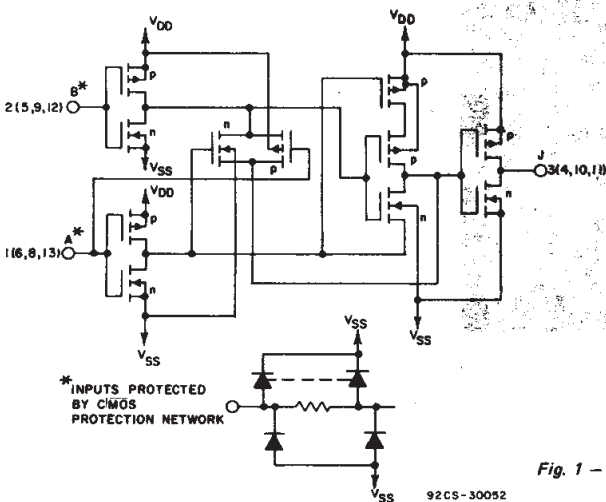

TRUTH TABLE FOR ONE OF FOUR IDENTICAL GATES

A	B	J
0	0	0
1	0	1
0	1	1
1	1	0

1 = HIGH LEVEL
0 = LOW LEVEL

Fig. 1 - Schematic diagram (1 of 4 identical gates).

CD4030B Types

STATIC ELECTRICAL CHARACTERISTICS

CHARACTERISTIC	CONDITIONS			LIMITS AT INDICATED TEMPERATURES (°C)							UNITS
	V _O (V)	V _{IN} (V)	V _{DD} (V)	-55	-40	+85	+125	+25			
								Min.	Typ.	Max.	
Quiescent Device Current, I _{DD} Max.	—	0,5	5	0.25	0.25	7.5	7.5	—	0.01	0.25	μA
	—	0,10	10	0.5	0.5	15	15	—	0.01	0.5	
	—	0,15	15	1	1	30	30	—	0.01	1	
	—	0,20	20	5	5	150	150	—	0.02	5	
Output Low (Sink) Current I _{OL} Min.	0.4	0,5	5	0.64	0.61	0.42	0.36	0.51	1	—	mA
	0.5	0,10	10	1.6	1.5	1.1	0.9	1.3	2.6	—	
	1.5	0,15	15	4.2	4	2.8	2.4	3.4	6.8	—	
Output High (Source) Current, I _{OH} Min.	4.6	0,5	5	-0.64	-0.61	-0.42	-0.36	-0.51	-1	—	mA
	2.5	0,5	5	-2	-1.8	-1.3	-1.15	-1.6	-3.2	—	
	9.5	0,10	10	-1.6	-1.5	-1.1	-0.9	-1.3	-2.6	—	
	13.5	0,15	15	-4.2	-4	-2.8	-2.4	-3.4	-6.8	—	
Output Voltage: Low-Level, V _{OL} Max.	—	0,5	5	0.05				—	0	0.05	V
	—	0,10	10	0.05				—	0	0.05	
	—	0,15	15	0.05				—	0	0.05	
Output Voltage: High-Level, V _{OH} Min.	—	0,5	5	4.95				4.95	5	—	V
	—	0,10	10	9.95				9.95	10	—	
	—	0,15	15	14.95				14.95	15	—	
Input Low Voltage, V _{IL} Max.	0.5, 4.5	—	5	1.5				—	—	1.5	V
	1,9	—	10	3				—	—	3	
	1.5, 13.5	—	15	4				—	—	4	
Input High Voltage, V _{IH} Min.	0.5, 4.5	—	5	3.5				3.5	—	—	V
	1,9	—	10	7				7	—	—	
	1.5, 13.5	—	15	11				11	—	—	
Input Current I _{IN} Max.	—	0,18	18	±0.1	±0.1	±1	±1	—	±10 ⁻⁵	±0.1	μA

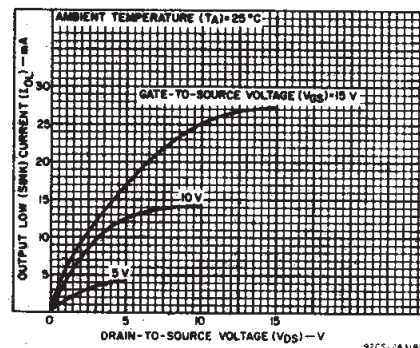

Fig. 2 - Typical output low (sink) current characteristics.

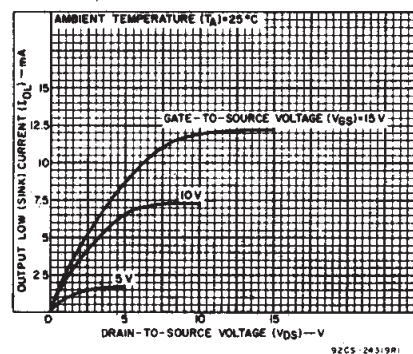

Fig. 3 - Minimum output low (sink) current characteristics.

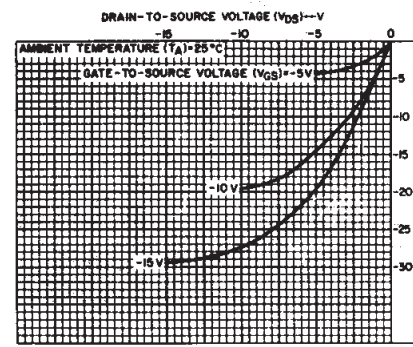

Fig. 4 - Typical output high (source) current characteristics.

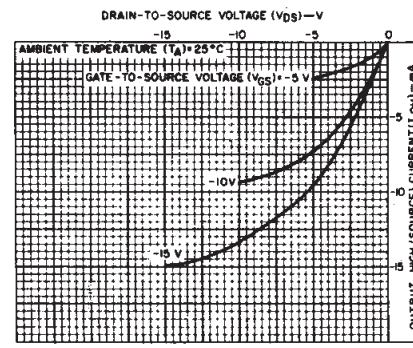

Fig. 5 - Minimum output high (source) current characteristics.

DYNAMIC ELECTRICAL CHARACTERISTICS at T_A = 25°C; Input t_r, t_f = 20 ns, C_L = 50 pF, R_L = 200 KΩ

CHARACTERISTIC	CONDITIONS	LIMITS		UNITS	
		V _{DD} (V)	LIMITS		
			Typ.		Max.
Propagation Delay Time, t _{PLH} , t _{PHL}	Any Input	5	140	280	ns
		10	65	130	
		15	50	100	
Transition Time, t _{THL} , t _{TLH}	Any Input	5	100	200	ns
		10	50	100	
		15	40	80	
Input Capacitance, C _{IN}	Any Input	5	7.5	pF	

COMMERCIAL CMOS HIGH VOLTAGE ICs

CD4030B Types

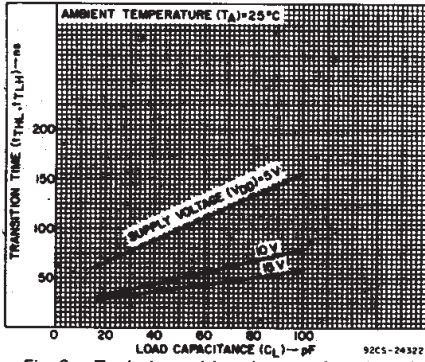

Fig. 6 - Typical transition time as a function of load capacitance.

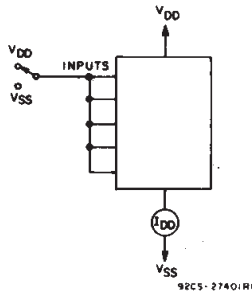

Fig. 10 - Quiescent-device current test circuit.

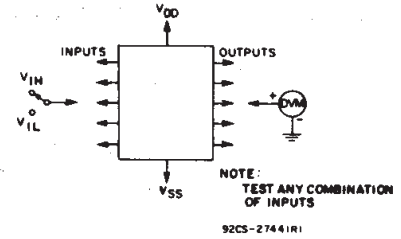

Fig. 11 - Input-voltage test circuit.

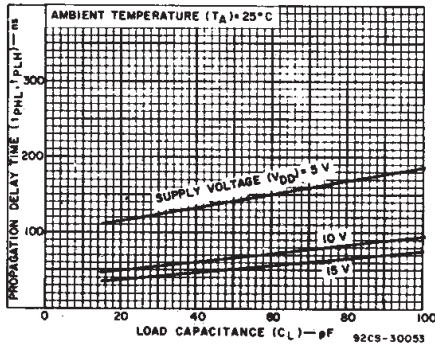

Fig. 7 - Typical propagation delay time as a function of load capacitance.

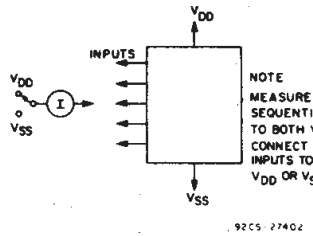

Fig. 12 - Input-current test circuit.

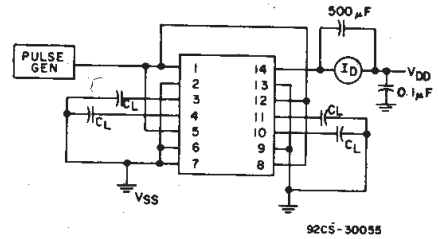

Fig. 13 - Dynamic power dissipation test circuit.

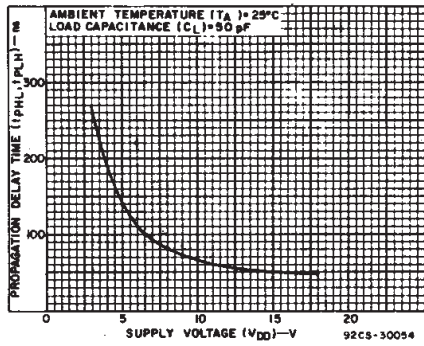

Fig. 8 - Typical propagation delay time as a function of supply voltage.

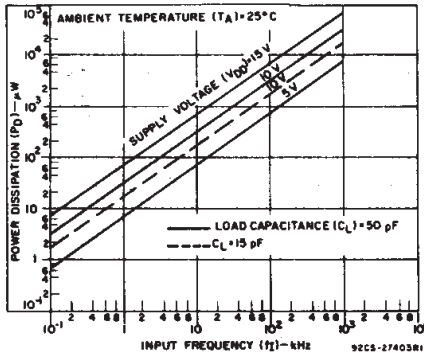
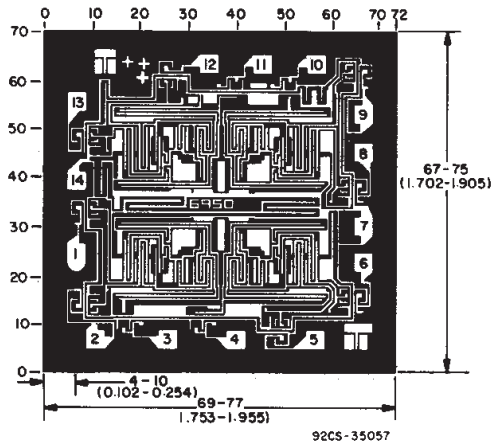

Fig. 9 - Typical dynamic power dissipation as a function of input frequency.



Dimensions and pad layout for CD4030BH.

Dimensions in parentheses are in millimeters and are derived from the basic inch dimensions as indicated. Grid graduations are in mils (10^{-3} inch).

PACKAGING INFORMATION

Orderable Device	Status ⁽¹⁾	Package Type	Package Drawing	Pins	Package Qty	Eco Plan ⁽²⁾	Lead/Ball Finish	MSL Peak Temp ⁽³⁾
CD4030BE	ACTIVE	PDIP	N	14	25	Pb-Free (RoHS)	CU NIPDAU	Level-NC-NC-NC
CD4030BEE4	ACTIVE	PDIP	N	14	25	Pb-Free (RoHS)	CU NIPDAU	Level-NC-NC-NC
CD4030BF	ACTIVE	CDIP	J	14	1	TBD	Call TI	Level-NC-NC-NC
CD4030BF3A	ACTIVE	CDIP	J	14	1	TBD	Call TI	Level-NC-NC-NC
CD4030BM	ACTIVE	SOIC	D	14	50	Green (RoHS & no Sb/Br)	CU NIPDAU	Level-1-260C-UNLIM
CD4030BM96	ACTIVE	SOIC	D	14	2500	Green (RoHS & no Sb/Br)	CU NIPDAU	Level-1-260C-UNLIM
CD4030BM96E4	ACTIVE	SOIC	D	14	2500	Green (RoHS & no Sb/Br)	CU NIPDAU	Level-1-260C-UNLIM
CD4030BME4	ACTIVE	SOIC	D	14	50	Green (RoHS & no Sb/Br)	CU NIPDAU	Level-1-260C-UNLIM
CD4030BMT	ACTIVE	SOIC	D	14	250	Green (RoHS & no Sb/Br)	CU NIPDAU	Level-1-260C-UNLIM
CD4030BMTE4	ACTIVE	SOIC	D	14	250	Green (RoHS & no Sb/Br)	CU NIPDAU	Level-1-260C-UNLIM
CD4030BNSR	ACTIVE	SO	NS	14	2000	Green (RoHS & no Sb/Br)	CU NIPDAU	Level-1-260C-UNLIM
CD4030BNSRE4	ACTIVE	SO	NS	14	2000	Green (RoHS & no Sb/Br)	CU NIPDAU	Level-1-260C-UNLIM
CD4030BPW	ACTIVE	TSSOP	PW	14	90	Green (RoHS & no Sb/Br)	CU NIPDAU	Level-1-260C-UNLIM
CD4030BPWE4	ACTIVE	TSSOP	PW	14	90	Green (RoHS & no Sb/Br)	CU NIPDAU	Level-1-260C-UNLIM
CD4030BPWR	ACTIVE	TSSOP	PW	14	2000	Green (RoHS & no Sb/Br)	CU NIPDAU	Level-1-260C-UNLIM
CD4030BPWRE4	ACTIVE	TSSOP	PW	14	2000	Green (RoHS & no Sb/Br)	CU NIPDAU	Level-1-260C-UNLIM
JM38510/05353BCA	ACTIVE	CDIP	J	14	1	TBD	Call TI	Level-NC-NC-NC

⁽¹⁾ The marketing status values are defined as follows:

ACTIVE: Product device recommended for new designs.

LIFEBUY: TI has announced that the device will be discontinued, and a lifetime-buy period is in effect.

NRND: Not recommended for new designs. Device is in production to support existing customers, but TI does not recommend using this part in a new design.

PREVIEW: Device has been announced but is not in production. Samples may or may not be available.

OBSOLETE: TI has discontinued the production of the device.

⁽²⁾ Eco Plan - The planned eco-friendly classification: Pb-Free (RoHS) or Green (RoHS & no Sb/Br) - please check <http://www.ti.com/productcontent> for the latest availability information and additional product content details.

TBD: The Pb-Free/Green conversion plan has not been defined.

Pb-Free (RoHS): TI's terms "Lead-Free" or "Pb-Free" mean semiconductor products that are compatible with the current RoHS requirements for all 6 substances, including the requirement that lead not exceed 0.1% by weight in homogeneous materials. Where designed to be soldered at high temperatures, TI Pb-Free products are suitable for use in specified lead-free processes.

Green (RoHS & no Sb/Br): TI defines "Green" to mean Pb-Free (RoHS compatible), and free of Bromine (Br) and Antimony (Sb) based flame retardants (Br or Sb do not exceed 0.1% by weight in homogeneous material)

⁽³⁾ MSL, Peak Temp. -- The Moisture Sensitivity Level rating according to the JEDEC industry standard classifications, and peak solder temperature.

Important Information and Disclaimer:The information provided on this page represents TI's knowledge and belief as of the date that it is provided. TI bases its knowledge and belief on information provided by third parties, and makes no representation or warranty as to the accuracy of such information. Efforts are underway to better integrate information from third parties. TI has taken and continues to take reasonable steps to provide representative and accurate information but may not have conducted destructive testing or chemical analysis on incoming materials and chemicals. TI and TI suppliers consider certain information to be proprietary, and thus CAS numbers and other limited information may not be available for release.

In no event shall TI's liability arising out of such information exceed the total purchase price of the TI part(s) at issue in this document sold by TI to Customer on an annual basis.

J (R-GDIP-T**)

14 LEADS SHOWN

CERAMIC DUAL IN-LINE PACKAGE



DIM \ PINS **	14	16	18	20
A	0.300 (7,62) BSC	0.300 (7,62) BSC	0.300 (7,62) BSC	0.300 (7,62) BSC
B MAX	0.785 (19,94)	.840 (21,34)	0.960 (24,38)	1.060 (26,92)
B MIN	—	—	—	—
C MAX	0.300 (7,62)	0.300 (7,62)	0.310 (7,87)	0.300 (7,62)
C MIN	0.245 (6,22)	0.245 (6,22)	0.220 (5,59)	0.245 (6,22)



4040083/F 03/03

- NOTES:
- All linear dimensions are in inches (millimeters).
 - This drawing is subject to change without notice.
 - This package is hermetically sealed with a ceramic lid using glass frit.
 - Index point is provided on cap for terminal identification only on press ceramic glass frit seal only.
 - Falls within MIL STD 1835 GDIP1-T14, GDIP1-T16, GDIP1-T18 and GDIP1-T20.

N (R-PDIP-T**)

PLASTIC DUAL-IN-LINE PACKAGE

16 PINS SHOWN



- NOTES:
- A. All linear dimensions are in inches (millimeters).
 - B. This drawing is subject to change without notice.
 - Falls within JEDEC MS-001, except 18 and 20 pin minimum body length (Dim A).
 - The 20 pin end lead shoulder width is a vendor option, either half or full width.

D (R-PDSO-G14)

PLASTIC SMALL-OUTLINE PACKAGE



- NOTES:
- A. All linear dimensions are in inches (millimeters).
 - B. This drawing is subject to change without notice.
 - C. Body dimensions do not include mold flash or protrusion not to exceed 0.006 (0,15).
 - D. Falls within JEDEC MS-012 variation AB.

MECHANICAL DATA

NS (R-PDSO-G**)

PLASTIC SMALL-OUTLINE PACKAGE

14-PINS SHOWN



- NOTES:
- All linear dimensions are in millimeters.
 - This drawing is subject to change without notice.
 - Body dimensions do not include mold flash or protrusion, not to exceed 0,15.

PW (R-PDSO-G**)

PLASTIC SMALL-OUTLINE PACKAGE

14 PINS SHOWN



4040064/F 01/97

- NOTES: A. All linear dimensions are in millimeters.
 B. This drawing is subject to change without notice.
 C. Body dimensions do not include mold flash or protrusion not to exceed 0,15.
 D. Falls within JEDEC MO-153

IMPORTANT NOTICE

Texas Instruments Incorporated and its subsidiaries (TI) reserve the right to make corrections, modifications, enhancements, improvements, and other changes to its products and services at any time and to discontinue any product or service without notice. Customers should obtain the latest relevant information before placing orders and should verify that such information is current and complete. All products are sold subject to TI's terms and conditions of sale supplied at the time of order acknowledgment.

TI warrants performance of its hardware products to the specifications applicable at the time of sale in accordance with TI's standard warranty. Testing and other quality control techniques are used to the extent TI deems necessary to support this warranty. Except where mandated by government requirements, testing of all parameters of each product is not necessarily performed.

TI assumes no liability for applications assistance or customer product design. Customers are responsible for their products and applications using TI components. To minimize the risks associated with customer products and applications, customers should provide adequate design and operating safeguards.

TI does not warrant or represent that any license, either express or implied, is granted under any TI patent right, copyright, mask work right, or other TI intellectual property right relating to any combination, machine, or process in which TI products or services are used. Information published by TI regarding third-party products or services does not constitute a license from TI to use such products or services or a warranty or endorsement thereof. Use of such information may require a license from a third party under the patents or other intellectual property of the third party, or a license from TI under the patents or other intellectual property of TI.

Reproduction of information in TI data books or data sheets is permissible only if reproduction is without alteration and is accompanied by all associated warranties, conditions, limitations, and notices. Reproduction of this information with alteration is an unfair and deceptive business practice. TI is not responsible or liable for such altered documentation.

Resale of TI products or services with statements different from or beyond the parameters stated by TI for that product or service voids all express and any implied warranties for the associated TI product or service and is an unfair and deceptive business practice. TI is not responsible or liable for any such statements.

Following are URLs where you can obtain information on other Texas Instruments products and application solutions:

Products		Applications	
Amplifiers	amplifier.ti.com	Audio	www.ti.com/audio
Data Converters	dataconverter.ti.com	Automotive	www.ti.com/automotive
DSP	dsp.ti.com	Broadband	www.ti.com/broadband
Interface	interface.ti.com	Digital Control	www.ti.com/digitalcontrol
Logic	logic.ti.com	Military	www.ti.com/military
Power Mgmt	power.ti.com	Optical Networking	www.ti.com/opticalnetwork
Microcontrollers	microcontroller.ti.com	Security	www.ti.com/security
		Telephony	www.ti.com/telephony
		Video & Imaging	www.ti.com/video
		Wireless	www.ti.com/wireless

Mailing Address: Texas Instruments
Post Office Box 655303 Dallas, Texas 75265

Copyright © Each Manufacturing Company.

All Datasheets cannot be modified without permission.

This datasheet has been download from :

www.AllDataSheet.com

100% Free DataSheet Search Site.

Free Download.

No Register.

Fast Search System.

www.AllDataSheet.com