



STPS30150CT/CW/CFP

HIGH VOLTAGE POWER SCHOTTKY RECTIFIER

MAIN PRODUCT CHARACTERISTICS

$I_{F(AV)}$	2 x 15 A
V_{RRM}	150 V
T_j	175°C
$V_F(max)$	0.75 V

FEATURES AND BENEFITS

- HIGH JUNCTION TEMPERATURE CAPABILITY
- GOOD TRADE OFF BETWEEN LEAKAGE CURRENT AND FORWARD VOLTAGE DROP
- LOW LEAKAGE CURRENT
- INSULATED PACKAGE: TO-220FPAB
Insulating voltage: 2000V DC
Capacitance: 45pF
- AVALANCHE CAPABILITY SPECIFIED

DESCRIPTION

Dual center tap schottky rectifier designed for high frequency Switched Mode Power Supplies.

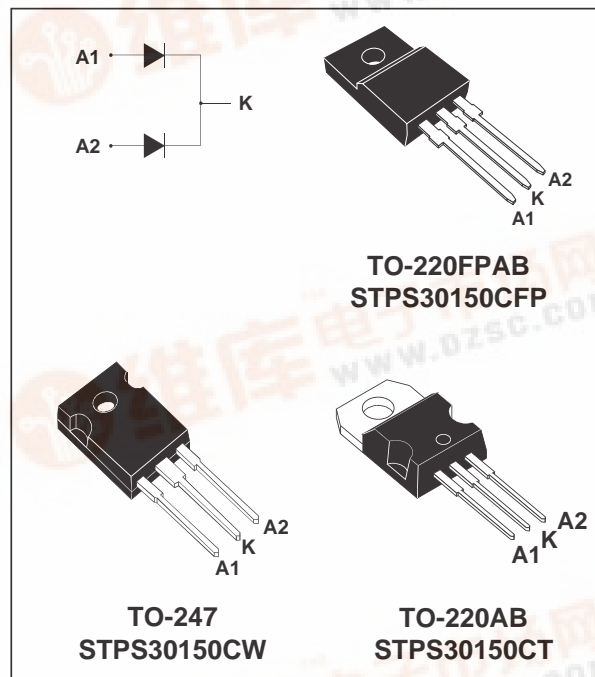

ABSOLUTE RATINGS (limiting values, per diode)

Symbol	Parameter			Value	Unit	
V_{RRM}	Repetitive peak reverse voltage			150	V	
$I_{F(RMS)}$	RMS forward current			30	A	
$I_{F(AV)}$	Average forward current $\delta = 0.5$	TO-220FPAB	$T_c = 110^\circ\text{C}$	per diode per device	15	A
		TO-220AB	$T_c = 155^\circ\text{C}$			
		TO-247		30		
I_{FSM}	Surge non repetitive forward current		$t_p = 10\text{ ms}$ sinusoidal	220	A	
P_{ARM}	Repetitive peak avalanche power		$t_p = 1\mu\text{s}$ $T_j = 25^\circ\text{C}$	10500	W	
T_{stg}	Storage temperature range			- 65 to + 175	°C	
T_j	Maximum operating junction temperature *			175	°C	
dV/dt	Critical rate of rise of reverse voltage			10000	V/ μs	

* : $\frac{dP_{tot}}{dT_j} < \frac{1}{R_{th(j-a)}}$ thermal runaway condition for a diode on its own heatsink

STPS30150CT/CW/CFP

THERMAL RESISTANCES

Symbol	Parameter		Value	Unit	
R _{th(j-c)}	Junction to case	TO-220FPAB	Per diode Total	4 3.3	°C/W
		TO-220AB	Per diode Total	1.6 0.85	
		TO-247	Per diode Total	1.5 0.8	
R _{th(c)}		TO-220FPAB	Coupling	2.6	
		TO-220AB	Coupling	0.1	
		TO-247	Coupling	0.1	

When the diodes 1 and 2 are used simultaneously :
 $\Delta T_j(\text{diode 1}) = P(\text{diode 1}) \times R_{th(j-c)}(\text{Per diode}) + P(\text{diode 2}) \times R_{th(c)}$

STATIC ELECTRICAL CHARACTERISTICS (per diode)

Symbol	Parameter	Tests conditions		Min.	Typ.	Max.	Unit
I _R *	Reverse leakage current	T _j = 25°C	V _R = V _{RRM}			6.5	μA
		T _j = 125°C				8	mA
V _F **	Forward voltage drop	T _j = 25°C	I _F = 15 A			0.92	V
		T _j = 125°C	I _F = 15 A		0.69	0.75	
		T _j = 25°C	I _F = 30 A			1	
		T _j = 125°C	I _F = 30 A		0.8	0.86	

Pulse test : * t_p = 5 ms, δ < 2%
 ** t_p = 380 μs, δ < 2%

To evaluate the conduction losses use the following equation:

$$P = 0.64 \times I_{F(AV)} + 0.0073 I_{F(RMS)}^2$$

Fig. 1: Average forward power dissipation versus average forward current (per diode).

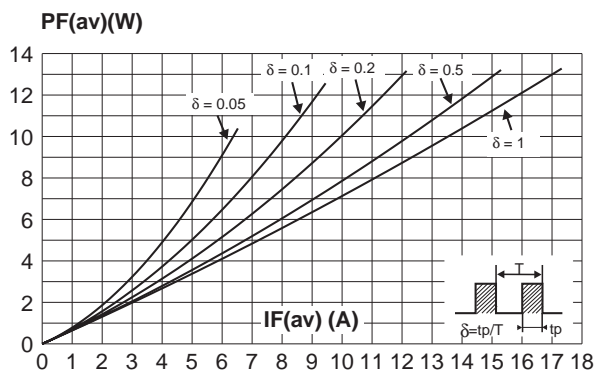

Fig. 2: Average forward current versus ambient temperature (δ = 0.5, per diode).

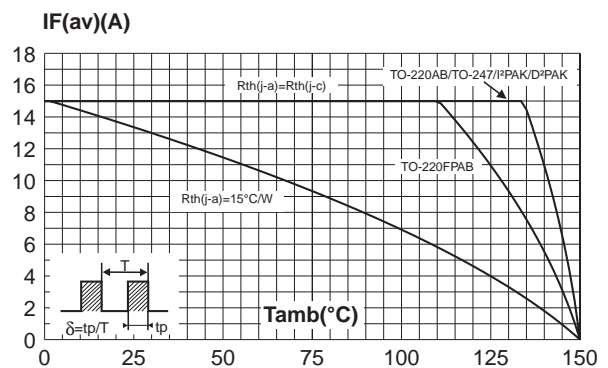

Fig. 3: Normalized avalanche power derating versus pulse duration.

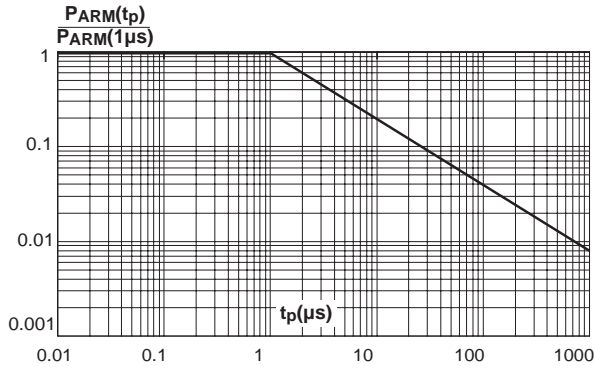

Fig. 4: Normalized avalanche power derating versus junction temperature.

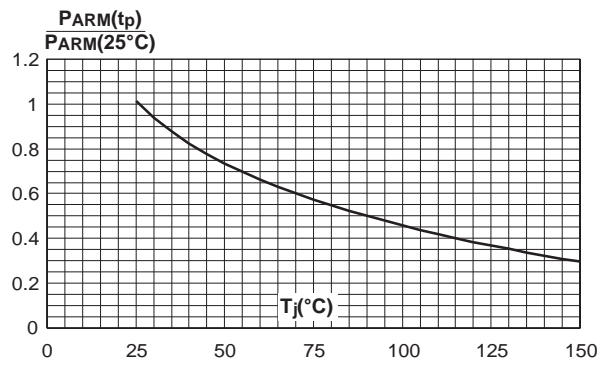

Fig. 5-1: Non repetitive surge peak forward current versus overload duration (maximum values, per diode).

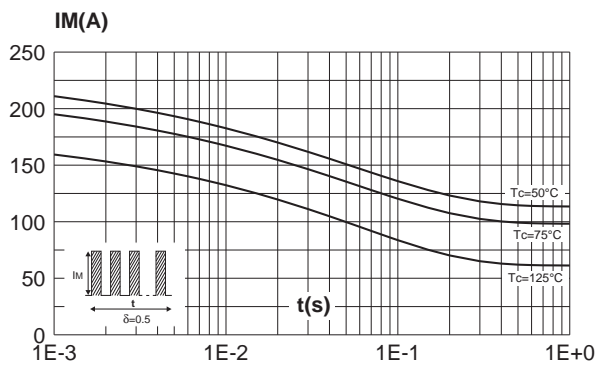

Fig. 5-2: Non repetitive surge peak forward current versus overload duration (maximum values, per diode) (TO-220FPAB only).

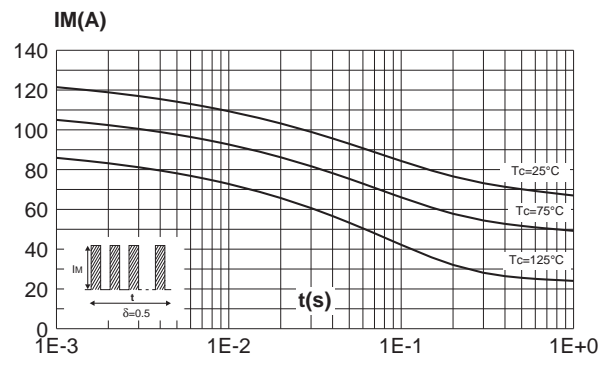

Fig. 6-1: Relative variation of thermal impedance junction to case versus pulse duration (per diode)

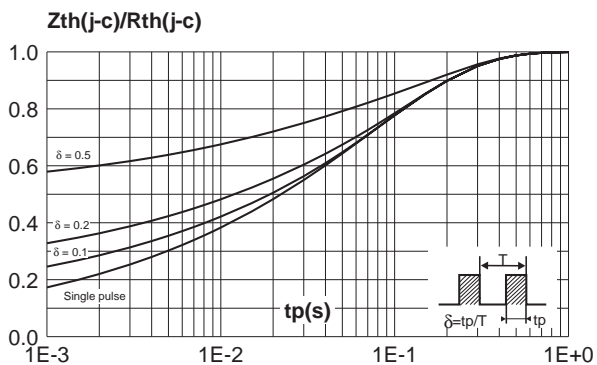
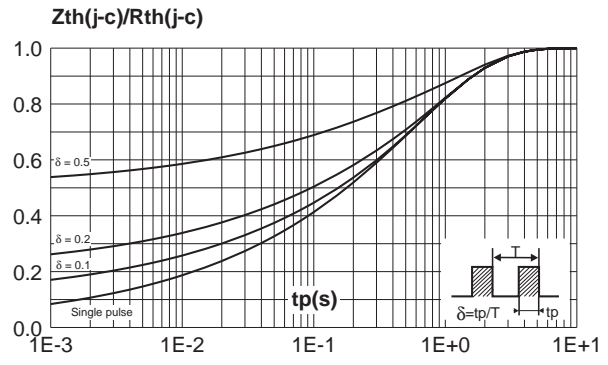

Fig. 6-2: Relative variation of thermal impedance junction to case versus pulse duration. (TO-220FPAB)



STPS30150CT/CW/CFP

Fig. 7: Reverse leakage current versus reverse voltage applied (typical values, per diode).

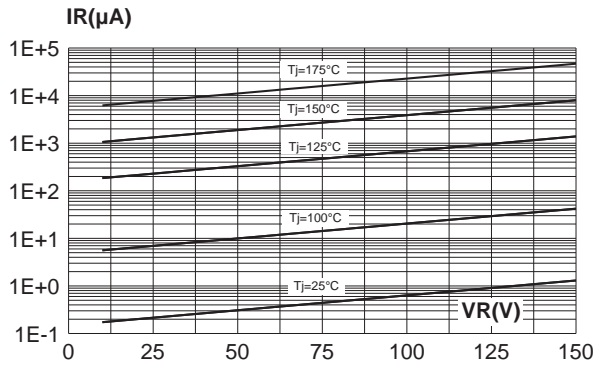

Fig. 8: Junction capacitance versus reverse voltage applied (typical values, per diode).

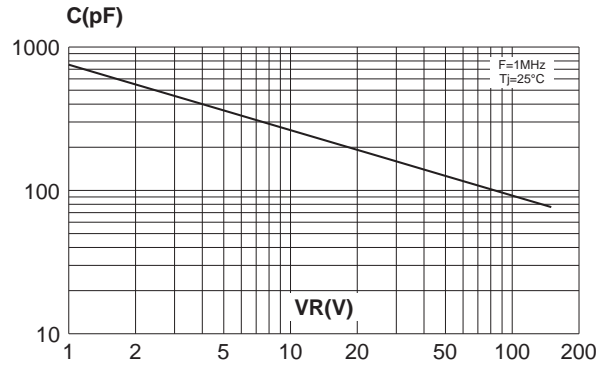
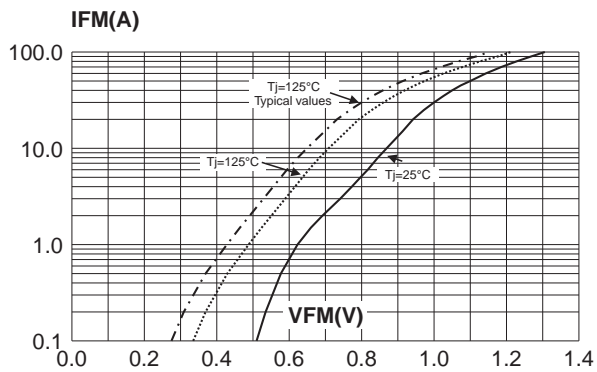
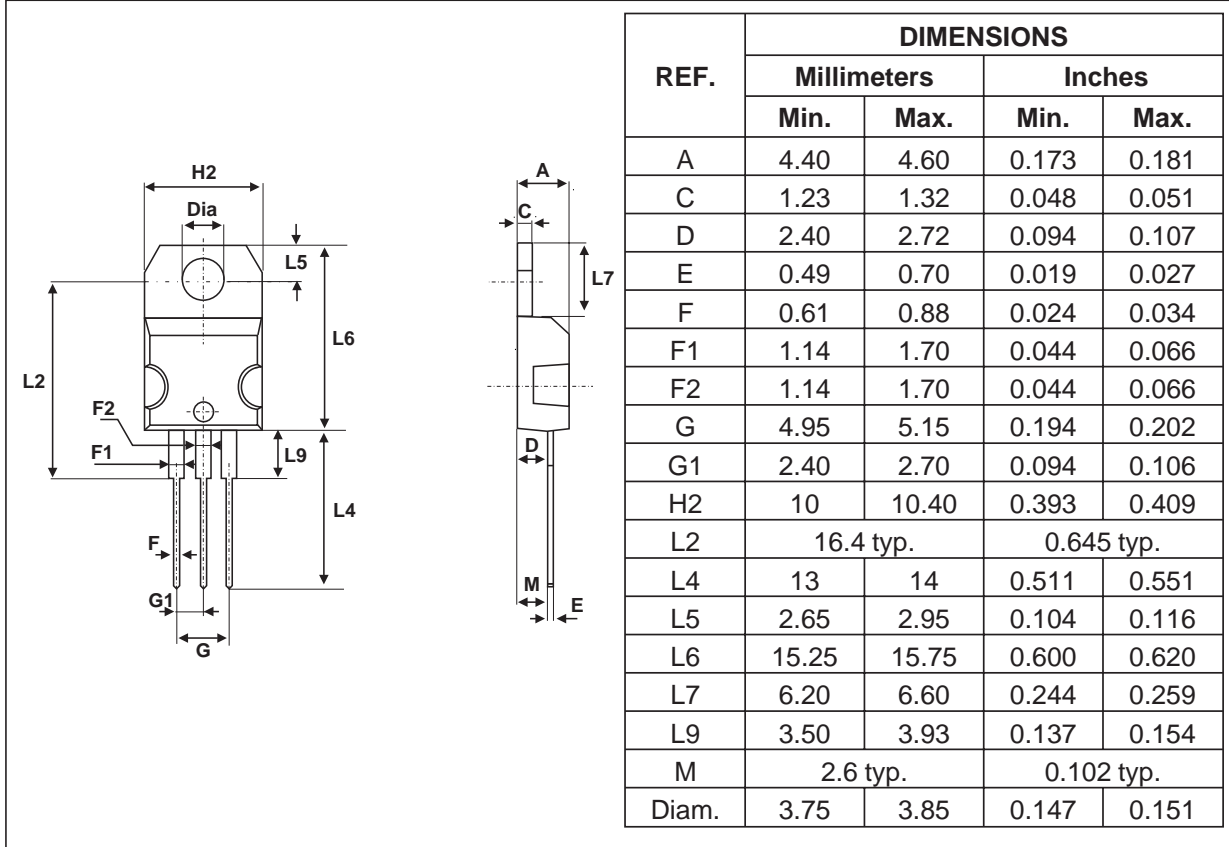

Fig. 9: Forward voltage drop versus forward current (maximum values, per diode).



PACKAGE MECHANICAL DATA
TO-220AB



PACKAGE MECHANICAL DATA
TO-220FPAB

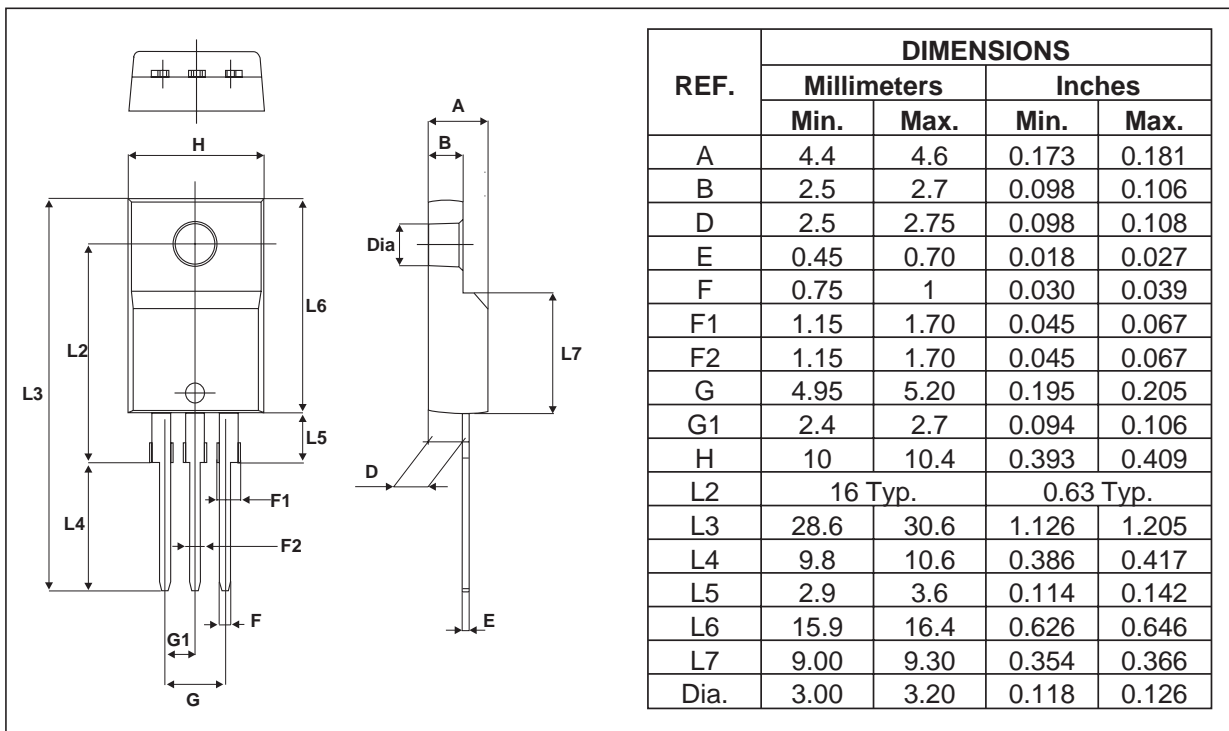

STPS30150CT/CW/CFP

PACKAGE MECHANICAL DATA TO-247

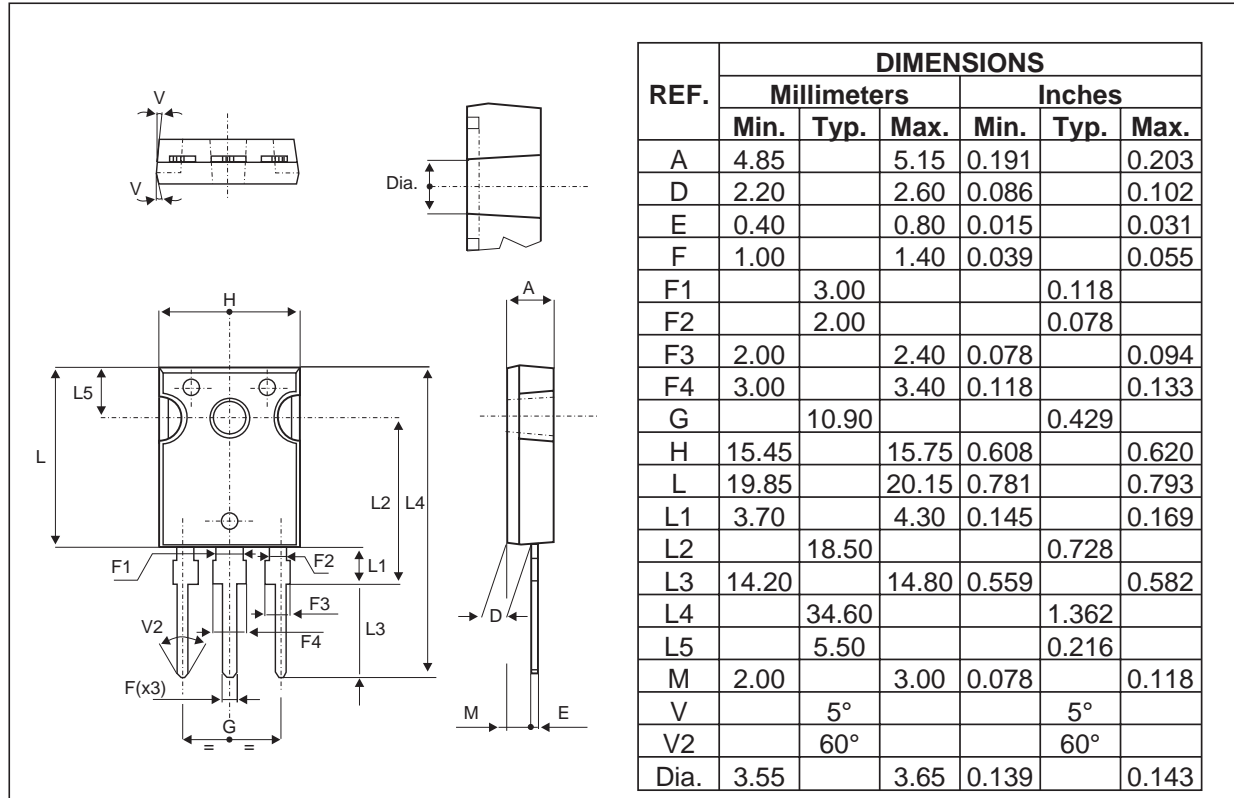

- Cooling method : C
- Recommended torque value : 0.8m.N
- Maximum torque value : 1.0m.N

Ordering Type	Marking	Package	Weight	Base qty	Delivery mode
STPS30150CT	STPS30150CT	TO-220AB	2 g	50	Tube
STPS30150CFP	STPS30150CFP	TO-220FPAB	1.9 g	50	Tube
STPS30150CW	STPS30150CW	TO-247	4.4 g	30	Tube

- Epoxy meets UL94, V0

Information furnished is believed to be accurate and reliable. However, STMicroelectronics assumes no responsibility for the consequences of use of such information nor for any infringement of patents or other rights of third parties which may result from its use. No license is granted by implication or otherwise under any patent or patent rights of STMicroelectronics. Specifications mentioned in this publication are subject to change without notice. This publication supersedes and replaces all information previously supplied.

STMicroelectronics products are not authorized for use as critical components in life support devices or systems without express written approval of STMicroelectronics.

The ST logo is a registered trademark of STMicroelectronics

© 2003 STMicroelectronics - Printed in Italy - All rights reserved.

STMicroelectronics GROUP OF COMPANIES

Australia - Brazil - Canada - China - Finland - France - Germany
 Hong Kong - India - Israel - Italy - Japan - Malaysia - Malta - Morocco - Singapore
 Spain - Sweden - Switzerland - United Kingdom - United States.

<http://www.st.com>