

8-CHANNEL, 12-/10-/8-BIT, 2.7-V TO 5.5-V LOW POWER DIGITAL-TO-ANALOG CONVERTERS WITH POWER DOWN AND INTERNAL REFERENCE

FEATURES

- **Eight Voltage Output DACs in One Package**
 - TLV5630 . . . 12-Bit
 - TLV5631 . . . 10-Bit
 - TLV5632 . . . 8-Bit
 - 1 μ s in Fast Mode
 - 3 μ s in Slow Mode
- **Programmable Settling Time vs Power Consumption**
 - 1 μ s in Fast Mode
 - 3 μ s in Slow Mode
 - 18 mW in Slow Mode at 3 V
 - 48 mW in Fast Mode at 3 V
- **Compatible With TMS320 and SPI Serial Ports**
- **Monotonic Over Temperature**
- **Low Power Consumption:**
 - 18 mW in Slow Mode at 3 V
 - 48 mW in Fast Mode at 3 V
- **Power-Down Mode**
- **Internal Reference**
- **Data Output for Daisy-Chaining**

APPLICATIONS

- **Digital Servo Control Loops**
- **Digital Offset and Gain Adjustment**
- **Industrial Process Control**
- **Machine and Motion Control Devices**
- **Mass Storage Devices**

DW OR PW PACKAGE
(TOP VIEW)

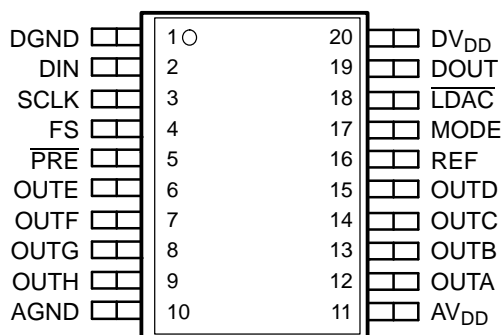

DESCRIPTION

The TLV5630, TLV5631, and TLV5632 are pin-compatible, eight-channel, 12-/10-/8-bit voltage output DACs each with a flexible serial interface. The serial interface allows glueless interface to TMS320 and SPI, QSPI, and Microwire serial ports. It is programmed with a 16-bit serial string containing 4 control and 12 data bits.

Additional features are a power-down mode, an LDAC input for simultaneous update of all eight DAC outputs, and a data output which can be used to cascade multiple devices, and an internal programmable band-gap reference.

The resistor string output voltage is buffered by a rail-to-rail output amplifier with a programmable settling time to allow the designer to optimize speed vs power dissipation. The buffered, high-impedance reference input can be connected to the supply voltage.

Implemented with a CMOS process, the DACs are designed for single-supply operation from 2.7 V to 5.5 V. The devices are available in 20-pin SOIC and TSSOP packages.



Please be aware that an important notice concerning availability, standard warranty, and use in critical applications of Texas Instruments semiconductor products and disclaimers thereto appears at the end of this data sheet.



These devices have limited built-in ESD protection. The leads should be shorted together or the device placed in conductive foam during storage or handling to prevent electrostatic damage to the MOS gates.

AVAILABLE OPTIONS

T _A	PACKAGE		
	SOIC (DW)	TSSOP (PW)	RESOLUTION
40°C to 85°C	TLV5630IDW	TLV5630IPW	12
	TLV5631IDW	TLV5631IPW	10
	TLV5632IDW	TLV5632IPW	8

FUNCTIONAL BLOCK DIAGRAM

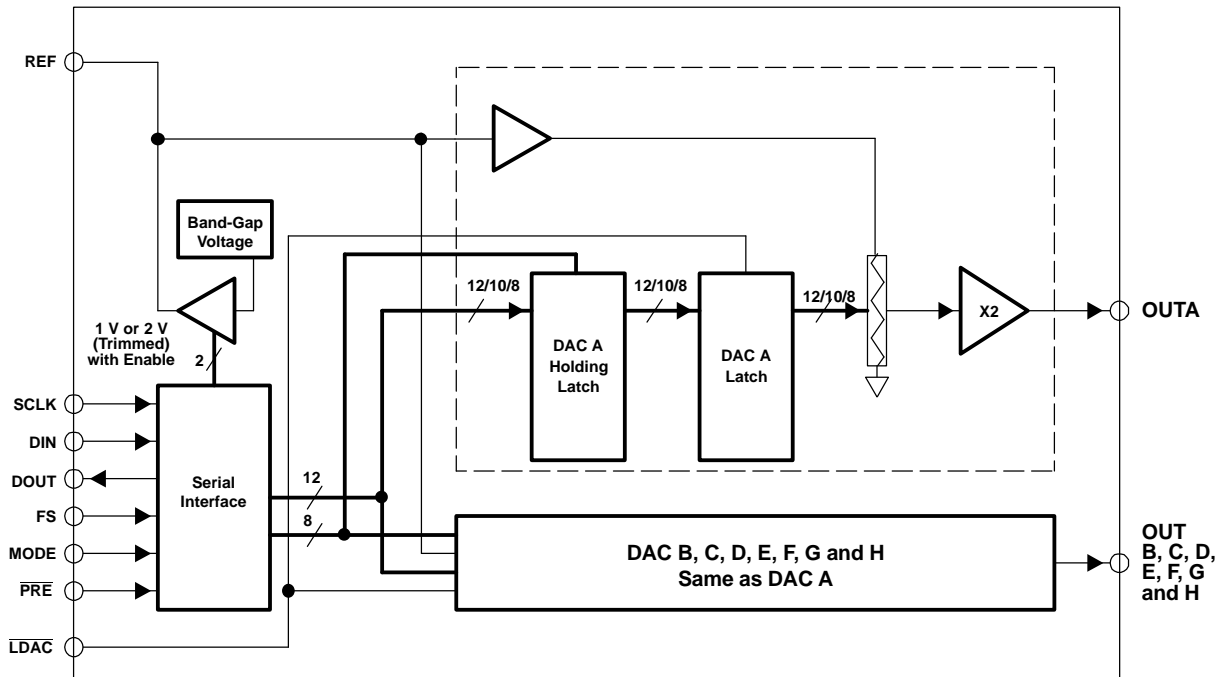

Terminal Functions

TERMINAL NAME	NO.	I/O	DESCRIPTION
AGND	10	P	Analog ground
AV _{DD}	11	P	Analog power supply
DGND	1	P	Digital ground
DIN	2	I	Digital serial data input
DOUT	19	O	Digital serial data output
DV _{DD}	20	P	Digital power supply
FS	4	I	Frame sync input
LDAC	18	I	Load DAC. The DAC outputs are only updated, if this signal is low. It is an asynchronous input.
MODE	17	I	DSP/μC mode pin. High = μC mode, NC = DSP mode.
PRE	5	I	Preset input
REF	16	I/O	Voltage reference input/output
SCLK	3	I	Serial clock input
OUTA-OUTH	12-15, 6-9	O	DAC outputs A, B, C, D, E, F, G and H

ABSOLUTE MAXIMUM RATINGS

over operating free-air temperature (unless otherwise noted) ⁽¹⁾

	UNIT
Supply voltage, (AV_{DD} , DV_{DD} to GND)	7 V
Reference input voltage range	- 0.3 V to $AV_{DD} + 0.3$
Digital input voltage range	- 0.3 V to $DV_{DD} + 0.3$
Operating free-air temperature range, T_A	-40°C to 85°C
Storage temperature range, T_{stg}	-65°C to 150°C
Lead temperature 1,6 mm (1/16 inch) from case for 10 seconds	260°C

(1) Stresses beyond those listed under, "absolute maximum ratings" may cause permanent damage to the device. These are stress ratings only, and functional operation of the device at these or any other conditions beyond those indicated under, "recommended operating conditions" is not implied. Exposure to absolute-maximum-rated conditions for extended periods may affect device reliability.

RECOMMENDED OPERATING CONDITIONS

		MIN	TYP	MAX	UNIT
Supply voltage, AV_{DD} , DV_{DD}	5-V operation	4.5	5	5.5	V
	3-V operation	2.7	3	3.3	V
High-level digital input, V_{IH}	$DV_{DD} = 2.7$ V	2			V
	$DV_{DD} = 5.5$ V	2.4			V
Low-level digital input, V_{IL}	$DV_{DD} = 2.7$ V			0.6	V
	$DV_{DD} = 5.5$ V			1.0	V
Reference voltage, V_{ref}	$AV_{DD} = 5$ V	GND	2.048	AV_{DD}	V
	$AV_{DD} = 3$ V	GND	1.024	AV_{DD}	V
Analog output load resistance, R_L		2			k Ω
Analog output load capacitance, C_L				100	pF
Clock frequency, f_{CLK}				30	MHz
Operating free-air temperature, T_A		-40		85	°C

ELECTRICAL CHARACTERISTICS

over recommended operating conditions (unless otherwise noted)

PARAMETER		TEST CONDITIONS		MIN	TYP	MAX	UNIT
POWER SUPPLY							
I_{DD}	Power supply current	No load, All inputs = DV_{DD} or GND, $V_{ref} = 2.048$ V,	Fast		16	21	mA
			Slow		6	8	
	Power-down supply current				0.1		μ A
POR	Power on threshold				2		V
PSRR	Power supply rejection ratio	Full scale, See (1)			50		dB
STATIC DAC SPECIFICATIONS							
Resolution		TLV5630			12		Bits
		TLV5631			10		Bits
		TLV5632			8		Bits
INL	Integral nonlinearity	TLV5630 TLV5631 TLV5632	$V_{ref} = 1$ V, 2 V	Code 40 to 4095	± 2	± 6	LSB
				Code 20 to 1023	± 0.5	± 2	LSB
				Code 6 to 255	± 0.3	± 1	LSB
DNL	Differential nonlinearity	TLV5630 TLV5631 TLV5632	$V_{ref} = 1$ V, 2 V	Code 40 to 4095	± 0.5	± 1	LSB
				Code 20 to 1023	± 0.1	± 1	LSB
				Code 6 to 255	± 0.1	± 1	LSB
E_{ZS}	Zero scale error (offset error at zero scale)					± 30	mV
E_{ZS} TC	Zero scale error temperature coefficient				30		μ V/ $^{\circ}$ C
E_G	Gain error					± 0.6	%Full Scale V
EGTC	Gain error temperature coefficient				10		ppm/ $^{\circ}$ C
OUTPUT SPECIFICATIONS							
V_O	Voltage output range	$R_L = 10$ k Ω		0		$AV_{DD}-0.4$	V
	Output load regulation accuracy	$R_L = 2$ k Ω vs 10 k Ω				± 0.3	%Full Scale V
REFERENCE OUTPUT							
V_{REFOU} TL	Low reference voltage	$V_{DD} > 4.75$ V		1.010	1.024	1.040	V
V_{REFOU} TH	High reference voltage			2.020	2.048	2.096	V
$I_{ref(Sourc$ e)	Output source current					1	mA
$I_{ref(Sink)}$	Output sink current			-1			mA
	Load capacitance	See (2)		1	10		μ F
PSRR	Power supply rejection ratio				60		dB
REFERENCE INPUT							
V_I	Input voltage range			0		AV_{DD}	V
R_I	Input resistance				50		k Ω
C_i	Input capacitance				10		pF
	Reference input bandwidth	$V_{ref} = 0.4$ V _{pp} + 2.048 Vdc, Input code = 0x800	Fast		2.2		MHz
			Slow		1.9		MHz

(1) Power supply rejection ratio at full scale is measured by varying AV_{DD} and is given by: $PSRR = 20 \log [(E_G(AV_{DDmax}) - E_G(AV_{DDmin}))/V_{DDmax}]$

(2) In parallel with a 100-nF capacitor

ELECTRICAL CHARACTERISTICS (continued)

over recommended operating conditions (unless otherwise noted)

PARAMETER		TEST CONDITIONS	MIN	TYP	MAX	UNIT
Reference feedthrough		$V_{ref} = 2 V_{pp}$ at 1 kHz + 2.048 Vdc, See ⁽³⁾		84		dB
DIGITAL INPUTS						
I_{IH}	High-level digital input current	$V_I = DV_{DD}$			1	μA
I_{IL}	Low-level digital input current	$V_I = 0 V$	1			μA
C_I	Input capacitance			8		pF
DIGITAL OUTPUT						
V_{OH}	High-level digital output voltage	$R_L = 10 k\Omega$	2.6			V
V_{OL}	Low-level digital output voltage	$R_L = 10 k\Omega$			0.4	V
	Output voltage rise time	$R_L = 10 k\Omega$, $C_L = 20 pF$, Includes propagation delay		5	10	ns
ANALOG OUTPUT DYNAMIC PERFORMANCE						
$t_{s(FS)}$	Output settling time, full scale	$R_L = 10 k\Omega$, $C_L = 100 pF$, See ⁽⁴⁾	Fast	1	3	μs
			Slow	3	7	
$t_{s(CC)}$	Output settling time, code to code	$R_L = 10 k\Omega$, $C_L = 100 pF$, See ⁽⁵⁾	Fast	0.5	1	μs
			Slow	1	2	
SR	Slew rate	$R_L = 10 k\Omega$, $C_L = 100 pF$, See ⁽⁶⁾	Fast	4	10	V/ μs
			Slow	1	3	
	Glitch energy	See ⁽⁷⁾		4		nV-s
	Channel crosstalk	10 kHz sine, 4 V_{PP}		90		dB

(3) Reference feedthrough is measured at the DAC output with an input code = 0x000.

(4) Settling time is the time for the output signal to remain within ± 0.5 LSB of the final measured value for a digital input code change of 0x080 to 0xFFFF and 0xFFFF to 0x080, respectively. Assured by design; not tested.

(5) Settling time is the time for the output signal to remain within ± 0.5 LSB of the final measured value for a digital input code change of one count. The max time applies to code changes near zero scale or full scale. Assured by design; not tested.

(6) Slew rate determines the time it takes for a change of the DAC output from 10% to 90% full-scale voltage.

(7) Code transition: TLV5630 - 0x7FF to 0x800, TLV5631 - 0x7FC to 0x800, TLV5632 - 0x7F0 to 0x800.

DIGITAL INPUT TIMING REQUIREMENTS

PARAMETER		MIN	TYP	MAX	UNIT
$t_{su(FS-CK)}$	Setup time, FS low before next negative SCLK edge	8			ns
$t_{su(C16-FS)}$	Setup time, 16 th negative edge after FS low on which bit D0 is sampled before rising edge of FS. μC mode only	10			ns
$t_{su(FS-C17)}$	μC mode, setup time, FS high before 17 th positive SCLK.	10			ns
$t_{su(CK-FS)}$	DSP mode, setup time, SCLK low before FS low.	5			ns
$t_{wL(LDAC)}$	LDAC duration low	10			ns
$t_{su(FS-CK)}$	Setup time, FS low before first negative SCLK edge	8			ns
t_{wL}	SCLK pulse duration low	16			
$t_{su(D)}$	Setup time, data ready before SCLK falling edge	8			ns
$t_{h(D)}$	Hold time, data held valid after SCLK falling edge	5			ns
$t_{wH(FS)}$	FS duration high	10			ns
$t_{wL(FS)}$	FS duration low	10			ns
t_s	Settling time	See AC specs			

TYPICAL CHARACTERISTICS

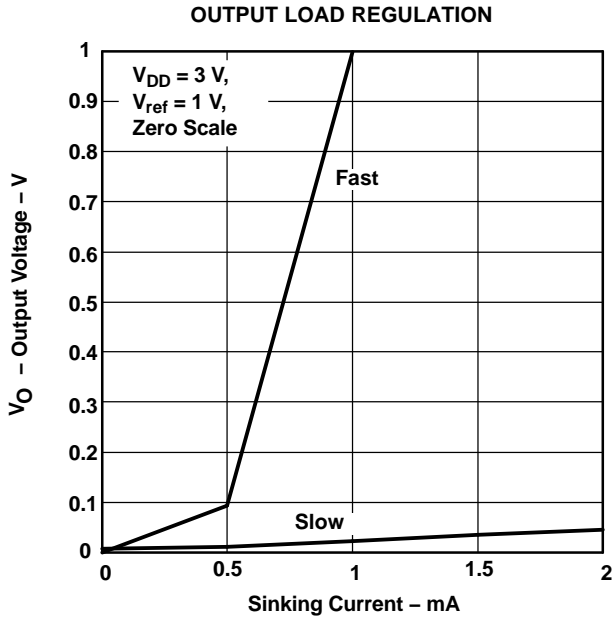

Figure 1.

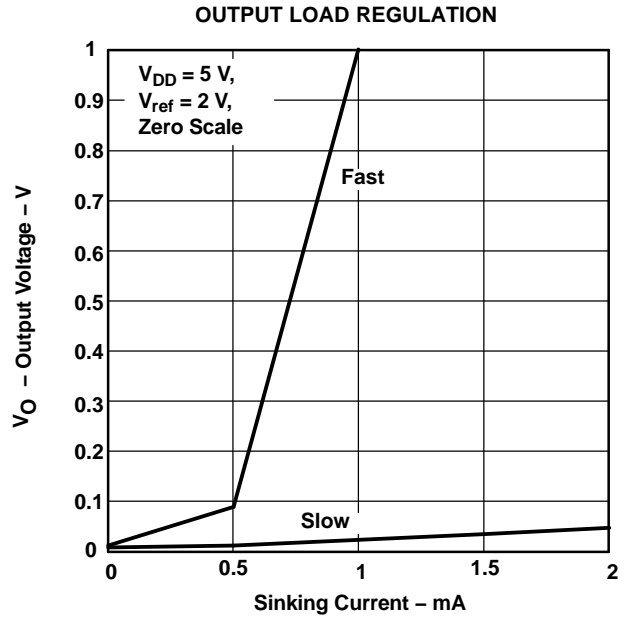

Figure 2.

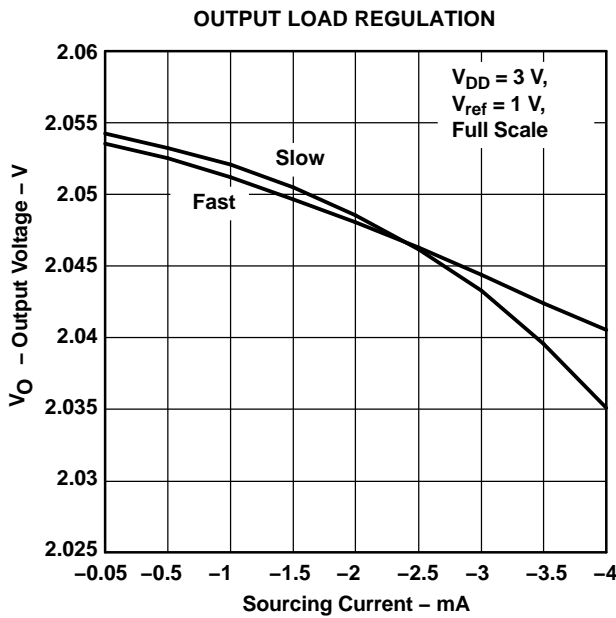

Figure 3.

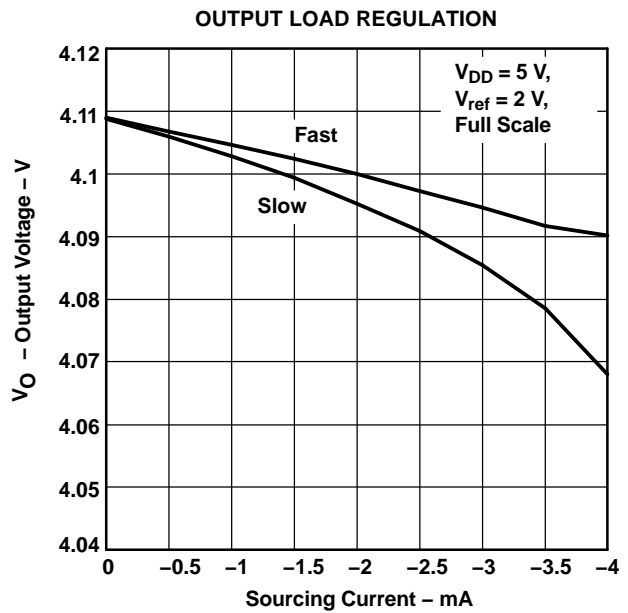

Figure 4.

TYPICAL CHARACTERISTICS (continued)

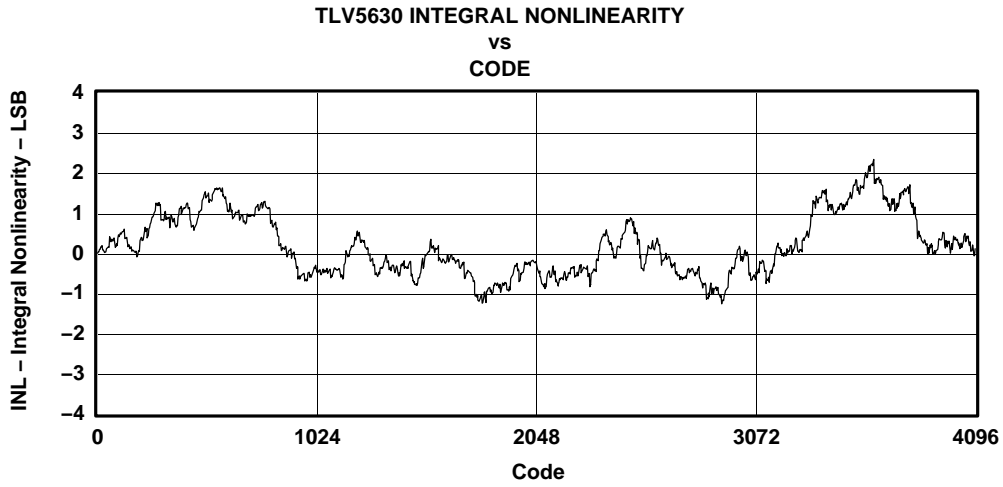

Figure 5.

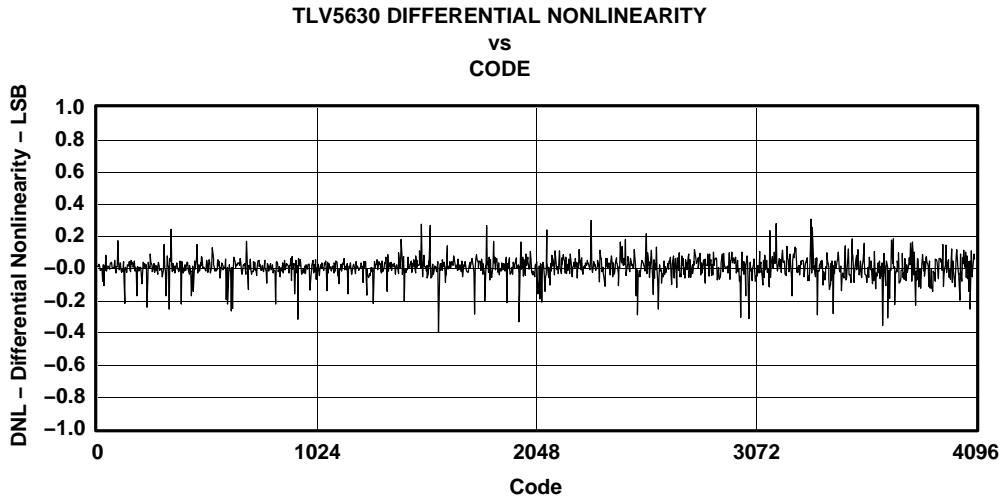

Figure 6.

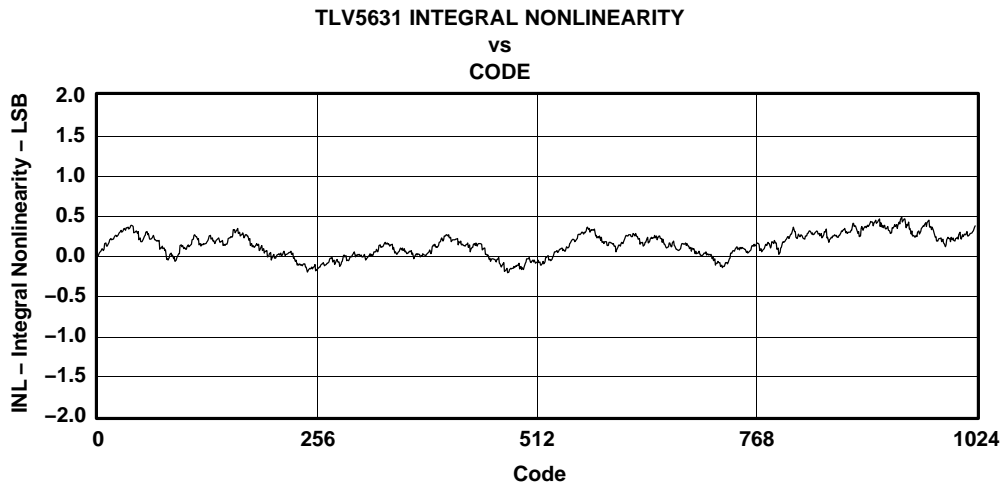

Figure 7.

TYPICAL CHARACTERISTICS (continued)

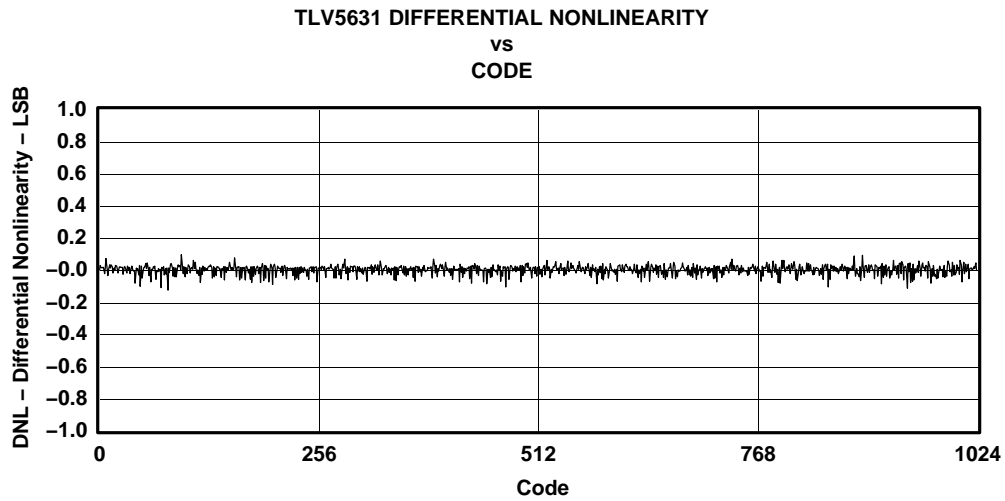

Figure 8.

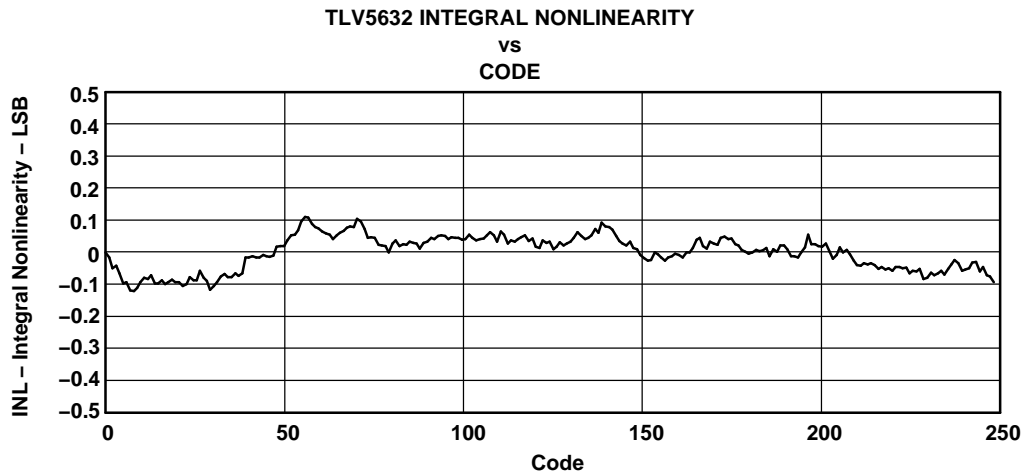

Figure 9.

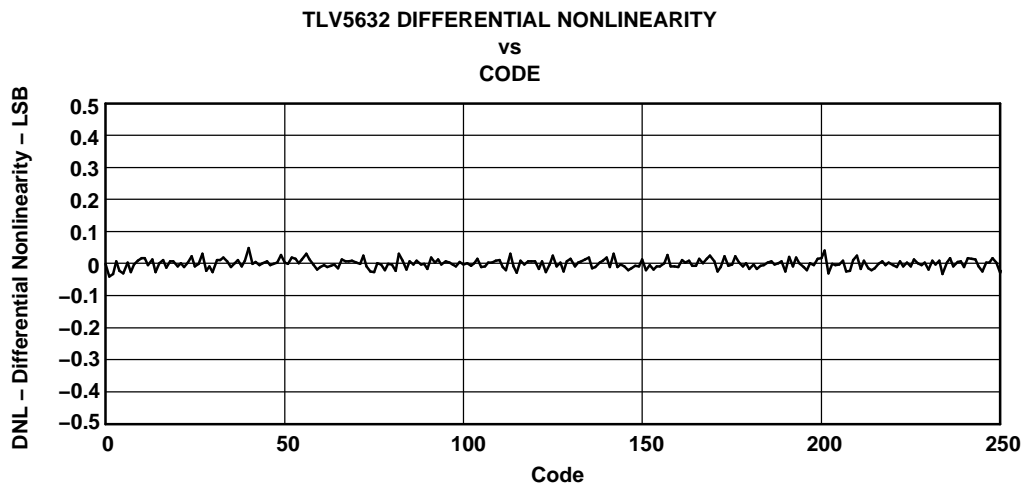
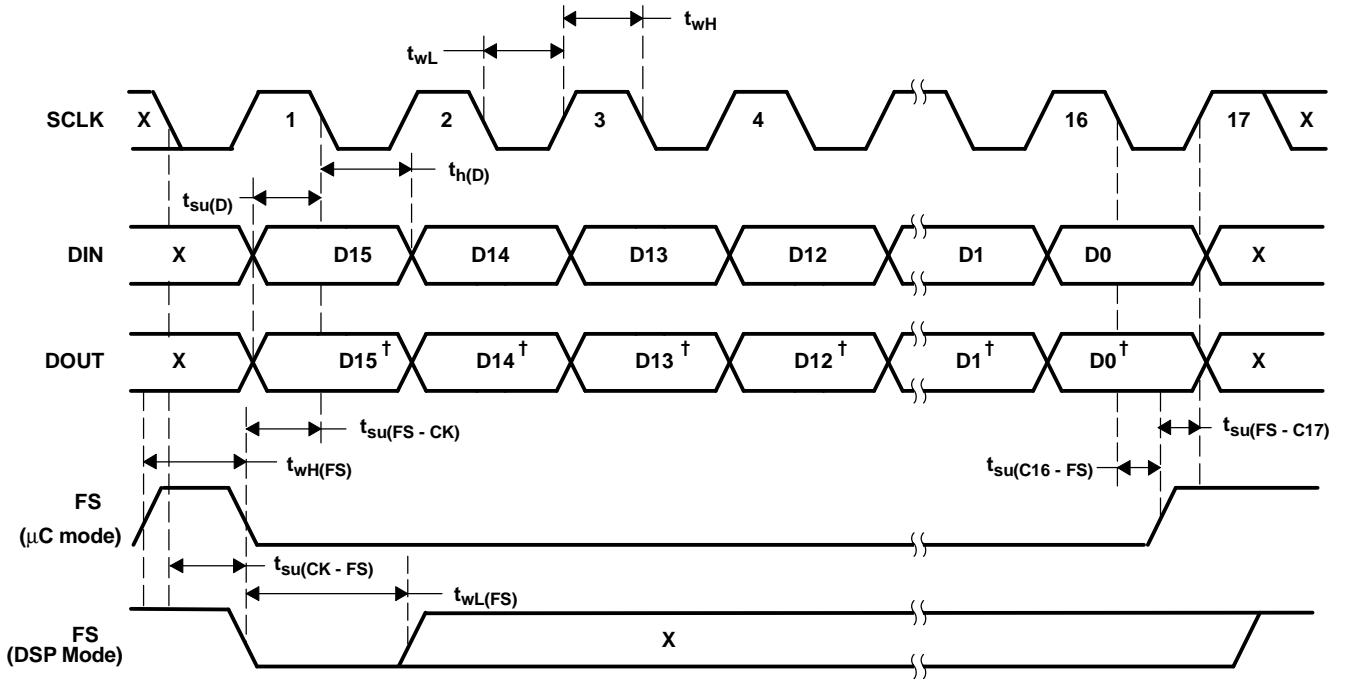

Figure 10.

PARAMETER MEASUREMENT INFORMATION



† Previous input data

Figure 11. Serial Interface Timing

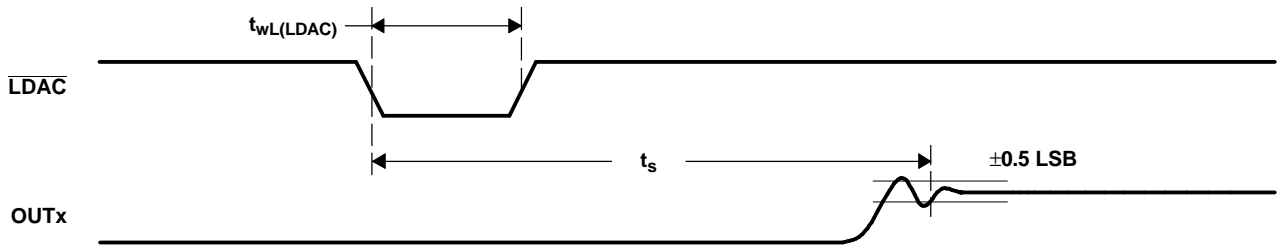

Figure 12. Output Timing

APPLICATION INFORMATION

GENERAL FUNCTION

The TLV5630/31/32 are 8-channel, single-supply DACs, based on a resistor string architecture. They consist of a serial interface, a speed and power-down control logic, an internal reference, a resistor string, and a rail-to-rail output buffer.

The output voltage (full scale determined by reference) for each channel is given by:

$$2\text{REF} \frac{\text{CODE}}{0\text{x}1000} [\text{V}]$$

where REF is the reference voltage and CODE is the digital input value. The input range is 0x000 to 0xFFF for the TLV5630, 0x000 to 0xFFC for the TLV5631, and 0x000 to 0xFF0 for the TLV5632. A power-on-reset initially puts the internal latches to a defined state (all bits zero).

SERIAL INTERFACE

A falling edge of FS starts shifting the data on DIN starting with the MSB to the internal register on the falling edges of SCLK. After 16 bits have been transferred, the content of the shift register is moved to one of the DAC holding registers, depending on the address bits within the data word. A logic 0 on the $\overline{\text{LDAC}}$ pin is required to transfer the content of the DAC holding register to the DAC latch and to update the DAC outputs. $\overline{\text{LDAC}}$ is an asynchronous input. It can be held low if a simultaneous update of all eight channels is not needed.

For daisy-chaining, DOUT provides the data sampled on DIN with a delay of 16 clock cycles.

DSP Mode:

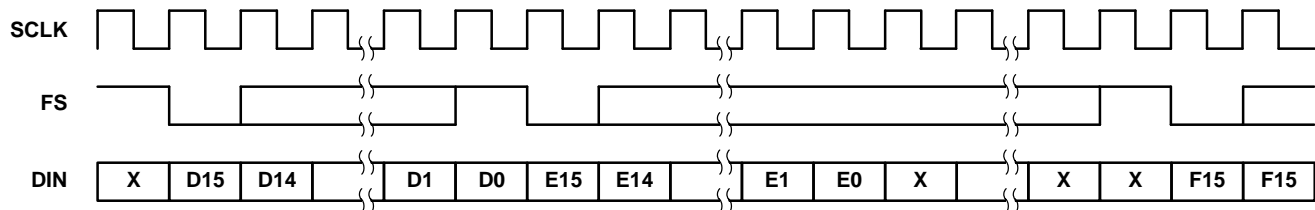

μC Mode:

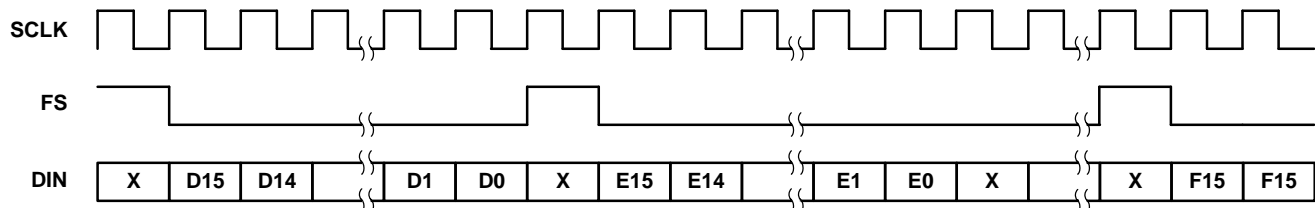

Difference between DSP mode (MODE = N.C. or 0) and μC (MODE = 1) mode:

- In μC mode, FS needs to be held low until all 16 data bits have been transferred. If FS is driven high before the 16th falling clock edge, the data transfer is cancelled. The DAC is updated after a rising edge on FS.
- In DSP mode, FS needs to stay low for 20 ns and can go high before the 16th falling clock edge.
- In DSP mode there needs to be one falling SCLK edge before FS goes low to start the write (DIN) cycle. This extra falling SCLK edge has to happen at least 5 ns before FS goes low, $t_{\text{su}(\text{CK-FS})} \geq 5 \text{ ns}$.
- In μC mode, the extra falling SCLK edge is not necessary. However, if it does happen, the extra negative SCLK edge is not allowed to occur within 10 ns after FS goes HIGH to finish the WRITE cycle ($t_{\text{su}(\text{FS-C17})}$).

APPLICATION INFORMATION (continued)
SERIAL CLOCK FREQUENCY AND UPDATE RATE

The maximum serial clock frequency is given by:

$$f_{\text{sclkmax}} = \frac{1}{t_{\text{whmin}} + t_{\text{wlmin}}} = 30 \text{ MHz}$$

The maximum update rate is:

$$f_{\text{updatemax}} = \frac{1}{16(t_{\text{whmin}} + t_{\text{wlmin}})} = 1.95 \text{ MHz}$$

Note, that the maximum update rate is just a theoretical value for the serial interface, as the settling time of the DAC has to be considered also.

DATA FORMAT

The 16-bit data word consists of two parts:

- Address bits (D15...D12)
- Data bits (D11...D0)

D15	D14	D13	D12	D11	D10	D9	D8	D7	D6	D5	D4	D3	D2	D1	D0
A3	A2	A1	A0	Data											

Ax: Address bits. See table.

REGISTER MAP

A3	A2	A1	A0	FUNCTION
0	0	0	0	DAC A
0	0	0	1	DAC B
0	0	1	0	DAC C
0	0	1	1	DAC D
0	1	0	0	DAC E
0	1	0	1	DAC F
0	1	1	0	DAC G
0	1	1	1	DAC H
1	0	0	0	CTRL0
1	0	0	1	CTRL1
1	0	1	0	Preset
1	0	1	1	Reserved
1	1	0	0	DAC A and \bar{B}
1	1	0	1	DAC C and \bar{D}
1	1	1	0	DAC E and \bar{F}
1	1	1	1	DAC G and \bar{H}

DAC A-H AND TWO-CHANNEL REGISTERS

Writing to DAC A-H sets the output voltage of channel A-H. It is possible to automatically generate the complement of one channel by writing to one of the four two-channel registers (DAC A and B etc.).

The TLV5630 decodes all 12 data bits. The TLV5631 decodes D11 to D2 (D1 and D0 are ignored). The TLV5632 decodes D11 to D4 (D3 to D0 are ignored).

PRESET

The outputs of all DAC channels can be driven to a predefined value stored in the Preset register by driving the \overline{PRE} input low. The \overline{PRE} input is asynchronous to the clock.

CTRL0

BIT	D11	D10	D9	D8	D7	D6	D5	D4	D3	D2	D1	D0
Function	X	X	X	X	X	X	X	PD	DO	R1	R0	IM
Default	X	X	X	X	X	X	X	0	0	0	0	0

PD : Full device power down 0 = normal 1 = power down
 DO : DOUT enable 0 = disabled 1 = enabled
 R1:0 : Reference select bits 0 = external 1 = external, 2 = internal 1 V, 3 = internal 2 V
 IM : Input mode 0 = straight binary 1 = twos complement
 X : Reserved

If DOUT is enabled, the data input on DIN is output on DOUT with a 16-cycle delay. That makes it possible to daisy-chain multiple DACs on one serial bus.

CTRL1

BIT	D11	D10	D9	D8	D7	D6	D5	D4	D3	D2	D1	D0
Function	X	X	X	X	P _{GH}	P _{EF}	P _{CD}	P _{AB}	S _{GH}	S _{EF}	S _{CD}	S _{AB}
Default	X	X	X	X	0	0	0	0	0	0	0	0

P_{XY} : Power Down DAC_{XY} 0 = normal 1 = power down
 S_{XY} : Speed DAC_{XY} 0 = slow 1 = fast
 XY : DAC pair AB, CD, EF or GH

In power-down mode, the amplifiers of the selected DAC pair are disabled and the total power consumption of the device is significantly reduced. Power-down mode of a specific DAC pair can be selected by setting the P_{XY} bit within the data word to 1.

There are two settling time modes: fast and slow. Fast mode of a DAC pair is selected by setting S_{XY} to 1 and slow mode is selected by setting S_{XY} to 0.

DW (R-PDSO-G20)

PLASTIC SMALL-OUTLINE PACKAGE



- NOTES:
- A. All linear dimensions are in inches (millimeters).
 - B. This drawing is subject to change without notice.
 - C. Body dimensions do not include mold flash or protrusion not to exceed 0.006 (0,15).
 - D. Falls within JEDEC MS-013 variation AC.

PW (R-PDSO-G**)

PLASTIC SMALL-OUTLINE PACKAGE

14 PINS SHOWN



4040064/F 01/97

- NOTES: A. All linear dimensions are in millimeters.
 B. This drawing is subject to change without notice.
 C. Body dimensions do not include mold flash or protrusion not to exceed 0,15.
 D. Falls within JEDEC MO-153

IMPORTANT NOTICE

Texas Instruments Incorporated and its subsidiaries (TI) reserve the right to make corrections, modifications, enhancements, improvements, and other changes to its products and services at any time and to discontinue any product or service without notice. Customers should obtain the latest relevant information before placing orders and should verify that such information is current and complete. All products are sold subject to TI's terms and conditions of sale supplied at the time of order acknowledgment.

TI warrants performance of its hardware products to the specifications applicable at the time of sale in accordance with TI's standard warranty. Testing and other quality control techniques are used to the extent TI deems necessary to support this warranty. Except where mandated by government requirements, testing of all parameters of each product is not necessarily performed.

TI assumes no liability for applications assistance or customer product design. Customers are responsible for their products and applications using TI components. To minimize the risks associated with customer products and applications, customers should provide adequate design and operating safeguards.

TI does not warrant or represent that any license, either express or implied, is granted under any TI patent right, copyright, mask work right, or other TI intellectual property right relating to any combination, machine, or process in which TI products or services are used. Information published by TI regarding third-party products or services does not constitute a license from TI to use such products or services or a warranty or endorsement thereof. Use of such information may require a license from a third party under the patents or other intellectual property of the third party, or a license from TI under the patents or other intellectual property of TI.

Reproduction of information in TI data books or data sheets is permissible only if reproduction is without alteration and is accompanied by all associated warranties, conditions, limitations, and notices. Reproduction of this information with alteration is an unfair and deceptive business practice. TI is not responsible or liable for such altered documentation.

Resale of TI products or services with statements different from or beyond the parameters stated by TI for that product or service voids all express and any implied warranties for the associated TI product or service and is an unfair and deceptive business practice. TI is not responsible or liable for any such statements.

Following are URLs where you can obtain information on other Texas Instruments products and application solutions:

Products		Applications	
Amplifiers	amplifier.ti.com	Audio	www.ti.com/audio
Data Converters	dataconverter.ti.com	Automotive	www.ti.com/automotive
DSP	dsp.ti.com	Broadband	www.ti.com/broadband
Interface	interface.ti.com	Digital Control	www.ti.com/digitalcontrol
Logic	logic.ti.com	Military	www.ti.com/military
Power Mgmt	power.ti.com	Optical Networking	www.ti.com/opticalnetwork
Microcontrollers	microcontroller.ti.com	Security	www.ti.com/security
		Telephony	www.ti.com/telephony
		Video & Imaging	www.ti.com/video
		Wireless	www.ti.com/wireless

Mailing Address: Texas Instruments
Post Office Box 655303 Dallas, Texas 75265

Copyright © Each Manufacturing Company.

All Datasheets cannot be modified without permission.

This datasheet has been download from :

www.AllDataSheet.com

100% Free DataSheet Search Site.

Free Download.

No Register.

Fast Search System.

www.AllDataSheet.com