



December 2002

# LM2760

## 3.3V Regulated Switched Capacitor Voltage Converter

### General Description

The LM2760 is a switched-capacitor DC/DC converter that generates a regulated 3.3V output capable of driving a load up to 20mA ( $V_{IN} \geq 2.5V$ ). The wide input voltage range (2.0V-4.4V) allows this device to be powered from several types of batteries, including single cell lithium-ion, two-cell alkaline, nickel-metal-hydrate, and nickel-cadmium. The LM2760 solution does not require an inductor and needs only three small external ceramic capacitors. The miniscule quiescent current of the part, typically 10µA unloaded, makes the LM2760 ideal for low-current standby power rails.

The LM2760 is a switched-capacitor circuit that is controlled by a gated oscillator. Both a low-input-voltage boost mode and high-input-voltage pass mode are implemented to optimize efficiency over the full input voltage range.

Additional features of the LM2760 include thermal protection and current limiting. The LM2760 is available in a small, five-pin SOT-23 package.

### Features

- 3.3V ± 4% Regulated Output
- Ultralow Power: 10µA Typical Supply Current
- Boost and Pass Modes for Improved Efficiency
- Input Voltage Range: 2.0V to 4.4V
- Output Current up to 20mA ( $V_{IN} \geq 2.5V$ )
- Output Current up to 10mA ( $V_{IN} \geq 2.0V$ )
- Inductorless solution
- Small external parts count: 3 ceramic capacitors
- 750kHz Switching Frequency
- SOT23-5 Package
- Short-Circuit and Thermal Protection

### Applications

- Battery-Operated Devices
- Cellular Phone
- Standby Power Supply
- Memory Keep-alive Power

### Typical Application Circuit

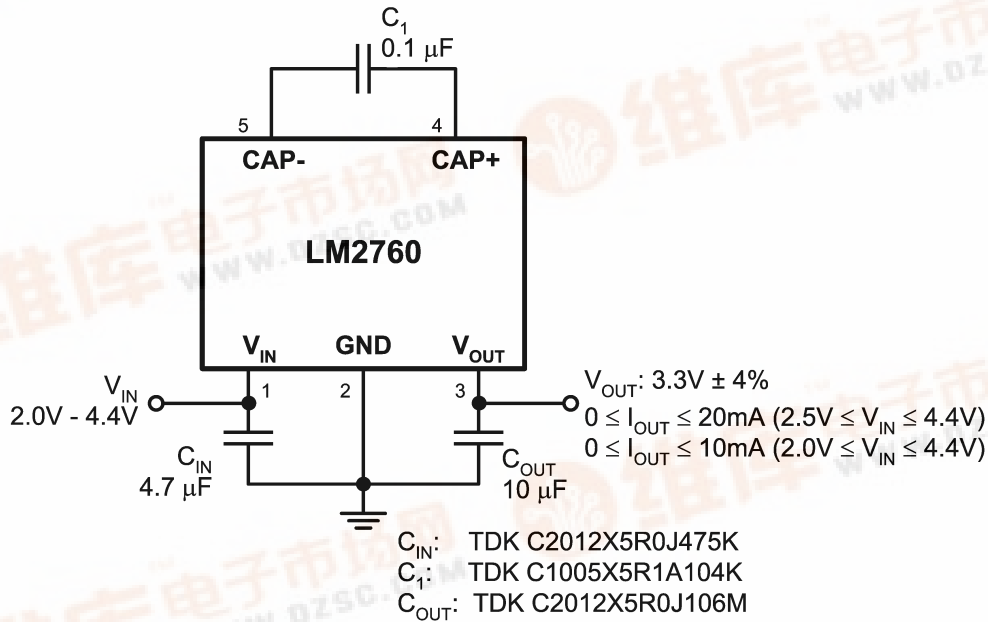

20044301

LM2760 3.3V Regulated Switched Capacitor Voltage Converter



## Connection Diagram

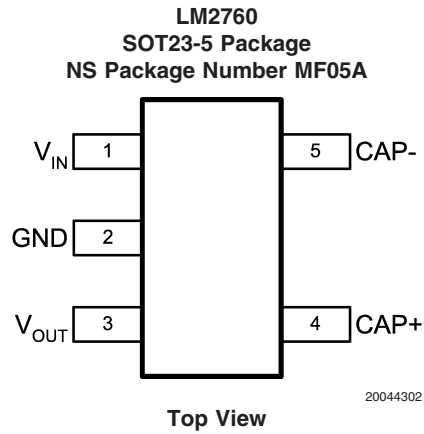

## Pin Description

Pin #(s)	Pin Name	Description
1	$V_{IN}$	Input supply connection
2	GND	Ground connection
3	$V_{OUT}$	Regulated 3.3V output
4	CAP+	Charge pump capacitor (+) connection
5	CAP-	Charge pump capacitor (-) connection

## Ordering Information

Order #	Package Type	Package Marking	Supplied as
LM2760M5	SOT23-5	S19B	Rail (250 units/rail)
LM2760M5X	SOT23-5	S19B	Tape and reel (3000 units/reel)

## Absolute Maximum Ratings (Notes 1, 2)

If Military/Aerospace specified devices are required, please contact the National Semiconductor Sales Office/Distributors for availability and specifications.

$V_{IN}$ Pin: Voltage to GND	-0.3V to 6V
Junction Temperature ( $T_{J-MAX-ABS}$ )	150°C
Continuous Power Dissipation	Internally Limited (Note 3)
$V_{OUT}$ Short-Circuit to GND Duration	Unlimited (Note 4)
Storage Temperature Range	-65°C to 150°C
Lead Temperature (Soldering, 5 sec.)	260°C
ESD Rating (Note 5)	
Human-body model:	2 kV
Machine model	200 V

## Operating Ratings (Notes 1, 2)

Input Voltage Range	2.0V to 4.4V
Recommended Output Current	
$2.5V \leq V_{IN} \leq 4.4V$	0mA to 20mA
$2.0V \leq V_{IN} \leq 2.5V$	0mA to 10mA
Junction Temperature ( $T_J$ ) Range	-40°C to 100°C
Ambient Temperature ( $T_A$ ) Range (Note 6)	-40°C to 85°C

## Thermal Information

Junction-to-Ambient Thermal Resistance ( $\theta_{JA}$ ), SOT23-5 Package (Note 7)	220°C/W
--	---------

## Electrical Characteristics (Notes 2, 8)

Typical values and limits in standard typeface apply for  $T_J = 25^\circ\text{C}$ . Limits in boldface type apply over the operating junction temperature range  $0^\circ\text{C} \leq T_J \leq +85^\circ\text{C}$  [ $0^\circ\text{C} \leq T_A \leq +70^\circ\text{C}$  (Note 9)] Unless otherwise specified:  $C_{IN} = 4.7\mu\text{F}$ ,  $C_{FLY} = 0.1\mu\text{F}$ ,  $C_{OUT} = 10\mu\text{F}$  (Note 10)

Symbol	Parameter	Conditions	Min	Typ	Max	Units
$V_{OUT}$	Output Voltage	$2.5V \leq V_{IN} \leq 4.4V$ , $0mA \leq I_{OUT} \leq 20mA$	<b>3.17</b>	3.3	<b>3.43</b>	V
		$2.0V \leq V_{IN} \leq 4.4V$ , $0mA \leq I_{OUT} \leq 10mA$	<b>3.17</b>	3.3	<b>3.43</b>	V
$I_Q$	Quiescent Supply Current	$2.0V \leq V_{IN} \leq 4.4V$ , $V_{OUT}$ tied to 3.5V, unloaded (Note 11)		6	<b>12</b>	$\mu\text{A}$
$I_{IN}$	Normal Operation Supply Current	$2.0V \leq V_{IN} \leq 4.4V$ , unloaded, Time-averaged (Note 12)		10		$\mu\text{A}$
$f_{OSC}$	Oscillator Frequency	$V_{IN} = 3.0V$		750		kHz
$V_{p-p}$	Output Ripple Voltage	$V_{IN} = 3.0V$ , $I_{OUT} = 10mA$		60		$mV_{p-p}$
$t_{ON}$	$V_{OUT}$ Turn-On Time	$V_{IN} = 3.0V$ (Note 13)		1		ms
$I_{SC}$	Output Short Circuit Current	$V_{IN} = 3.0V$		170		mA

**Note 1:** Absolute Maximum Ratings indicate limits beyond which damage to the component may occur. Operating Ratings are conditions under which operation of the device is guaranteed. Operating Ratings do not imply guaranteed performance limits. For guaranteed performance limits and associated test conditions, see the Electrical Characteristics tables.

**Note 2:** All voltages are with respect to the potential at the GND pin.

**Note 3:** Thermal shutdown circuitry protects the device from permanent damage.

**Note 4:** Excessive power dissipation will occur if the part is shorted to ground. Internal thermal shutdown will protect the device from permanent damage, but thermal cycling of the part is likely to occur until the short is removed. Protection is guaranteed only for  $V_{IN} \leq 4.4V$

**Note 5:** : The human-body model is a 100 pF capacitor discharged through a 1.5 k $\Omega$  resistor into each pin. The machine model is a 200pF capacitor discharged directly into each pin.

**Note 6:** Maximum ambient temperature ( $T_{A-MAX}$ ) is dependent on the maximum operating junction temperature ( $T_{J-MAX-OP} = 100^\circ\text{C}$ ), the maximum power dissipation of the device in the application ( $P_{D-MAX}$ ), and the junction-to-ambient thermal resistance of the part/package in the application ( $\theta_{JA}$ ), as given by the following equation:  $T_{A-MAX} = T_{J-MAX-OP} - (\theta_{JA} \times P_{D-MAX})$ . When application conditions are within the specified operating ratings, maximum power dissipation of the LM2760 is 70mW. This occurs when the output current is 20mA and the input voltage is 3.4V (edge of the "doubler" region). The maximum ambient temperature operating rating ( $T_{A-MAX}$ ) of 85°C is calculated using  $\theta_{JA} = 220^\circ\text{C/W}$  and  $P_{D-MAX} = 70\text{mW}$ . For more information on these topics, please refer to the **Power Dissipation** section of this datasheet.

**Note 7:** Junction-to-ambient thermal resistance ( $\theta_{JA}$ ) of the SOT23-5 package is taken from a thermal modeling result, performed under the conditions and guidelines set forth in the JEDEC standard JESD51-3. The test board is a 2-layer FR-4 board measuring 230mm x 125mm x 1.6mm. Thickness of the copper layers is 18mm (1.0oz). Ambient temperature in simulation is 22°C, still air. Power dissipation is 1W. Junction-to-ambient thermal resistance is a highly application-specific parameter. The value of  $\theta_{JA}$  of the LM2760 could fall in a range as wide as 150°C/W to 250°C/W (if not wider), depending on PCB and application conditions.

**Note 8:** : All room temperature limits are 100% tested or guaranteed through statistical analysis. All limits at temperature extremes are guaranteed by correlation using standard Statistical Quality Control methods (SQC). All limits are used to calculate Average Outgoing Quality Level (AOQL). Typical numbers are not guaranteed, but do represent the most likely norm.

**Note 9:** With  $P_{D-MAX}$  of 70mW and  $\theta_{JA}$  of 220°C/W (see Note 6), the ambient temperature range of 0°C-to-70°C is provided for convenience and is calculated from the 0°C-to-85°C junction temperature range that is used in determining guaranteed limits.

**Note 10:**  $C_{FLY}$ ,  $C_{IN}$ , and  $C_{OUT}$  : Low-ESR Surface-Mount Ceramic Capacitors (MLCCs) used in setting electrical characteristics

## Electrical Characteristics (Notes 2, 8) (Continued)

**Note 11:** In determining quiescent supply current limits, the voltage on the  $V_{OUT}$  pin is forced to 200mV above the typical  $V_{OUT}$  to ensure that the charge pump is inactive and all internal switches are off.

**Note 12:** The "normal operation" supply current specification is a measure of the time-averaged supply current when there is no current load connected to the output of the LM2760. During this so-called normal operation, the charge pump occasionally is activated to provide charge to the output cap and keep the output voltage from drooping. This is necessary because, when the pump is not active, the output capacitor supplies current to the internal feedback resistor divider. The occasional pumping typically occurs every 2 seconds on average, contains a few short pump cycles, and results in a small increase in the average quiescent supply current.

**Note 13:** Turn-on time is measured from when the input voltage ( $V_{IN}$ ) is established until the output voltage crosses 90% of its final value.

## Block Diagram

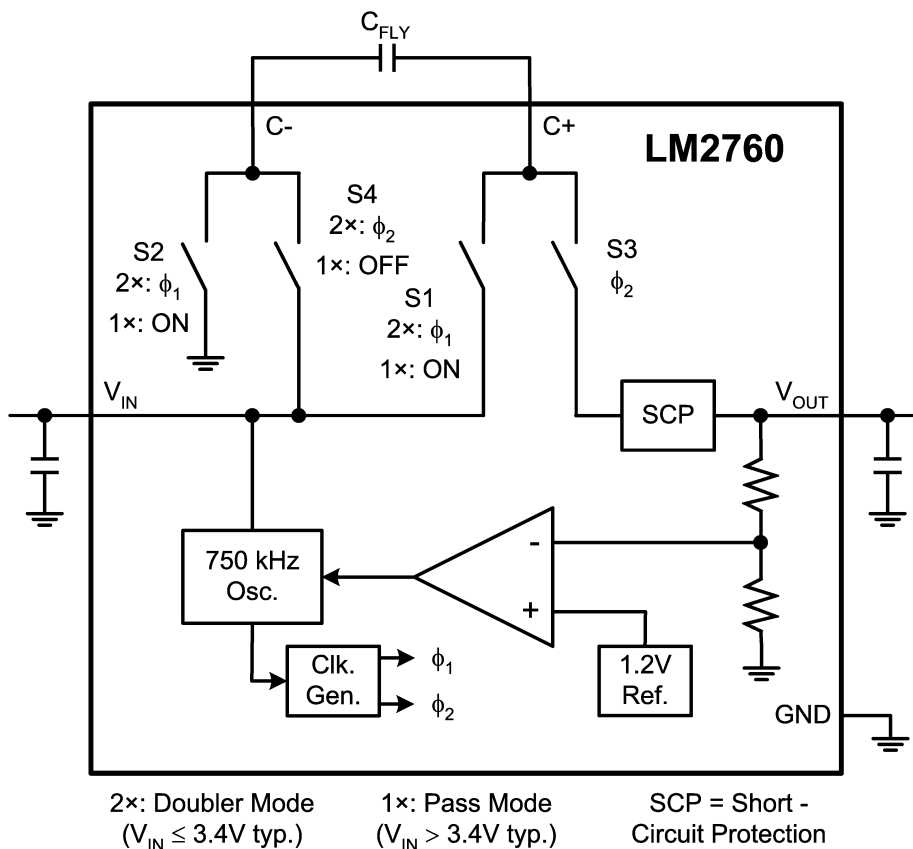

20044303

**Typical Performance Characteristics** Unless otherwise specified:  $V_{IN} = 3.0V$ ,  $T_A = 25^\circ C$ ,  $C_{IN} = 4.7\mu F$ ,  $C_{FLY} = 0.1\mu F$ ,  $C_{OUT} = 10\mu F$ . Capacitors are low-ESR multi-layer ceramic capacitors (MLCC's).

**Output Voltage vs. Input Voltage**

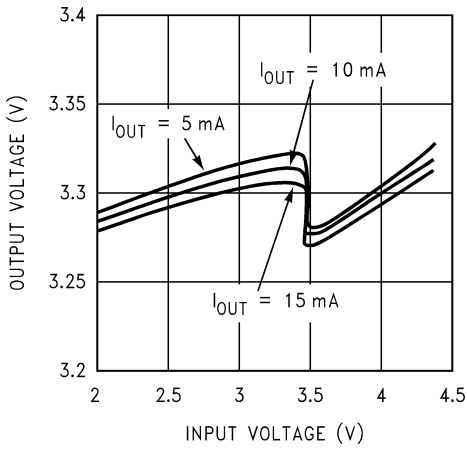

20044314

**Output Voltage vs. Output Current**

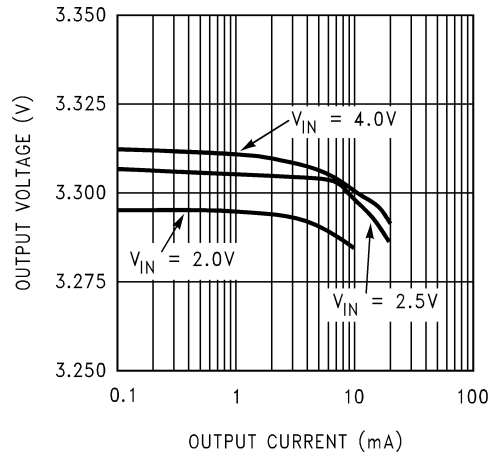

20044308

**Power Efficiency**

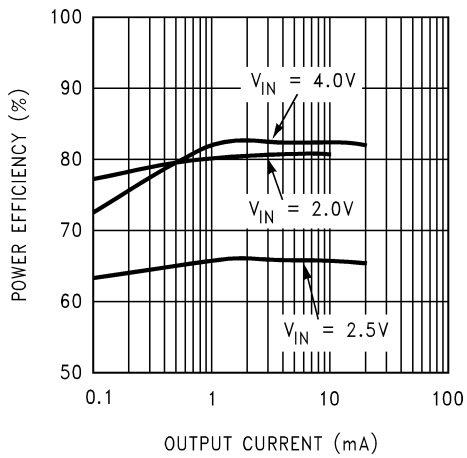

20044309

**No-Load Current vs. Input Voltage**

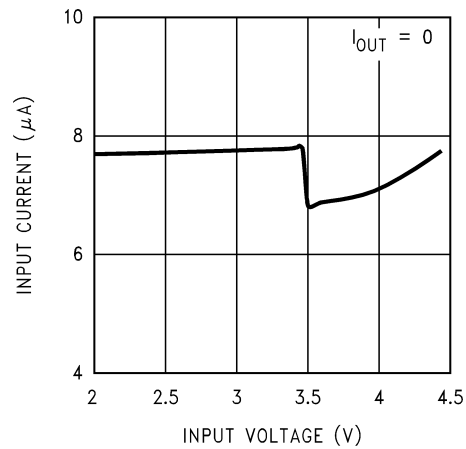

20044310

**Short Circuit Current vs. Input Voltage**

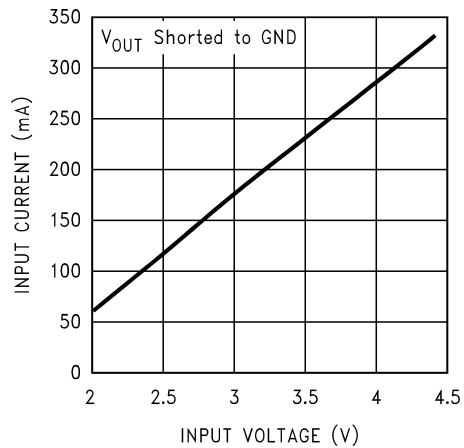

20044311

**Typical Performance Characteristics** Unless otherwise specified:  $V_{IN} = 3.0V$ ,  $T_A = 25^\circ C$ ,  $C_{IN} = 4.7\mu F$ ,  $C_{FLY} = 0.1\mu F$ ,  $C_{OUT} = 10\mu F$ . Capacitors are low-ESR multi-layer ceramic capacitors (MLCC's). (Continued)

**Output Voltage Ripple**

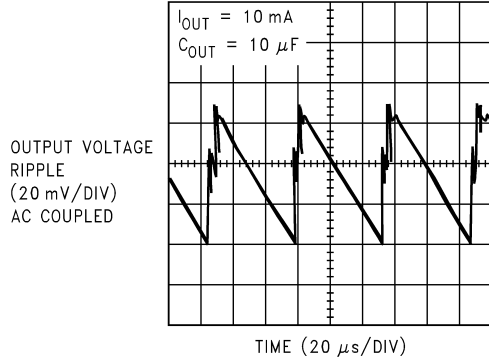

**Load Step Response**

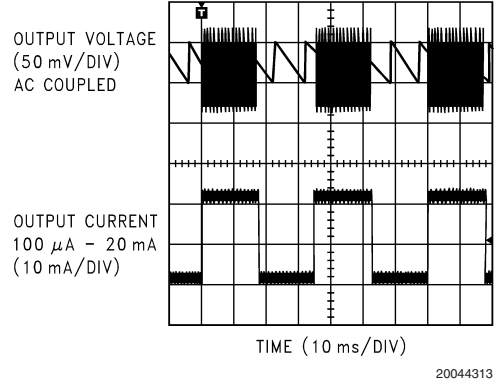

## Operation Description

### OVERVIEW

The LM2760 is a regulated switched capacitor converter that efficiently provides a regulated 3.3V output capable of supplying a load up to 20mA. The part has two regulation modes: a doubler mode and a pass mode. The part configures itself for doubler mode (2x) when the input voltage is low ( $< 3.4V$  typ.) and boost of the input voltage is required. At higher input voltages, voltage boost is not needed, so the part configures itself for pass mode (1x) to optimize efficiency. Efficiency is optimized even further, especially when output current is low, through the implementation of pulse-frequency-modulated (PFM) regulation. The descriptions in the sections to follow refer to the block diagram on the previous page.

### PULSE FREQUENCY MODULATED (PFM) REGULATION

The LM2760 uses pulse frequency modulation (PFM) to provide highly efficient output voltage regulation. PFM is a complicated-sounding term that simply means the part only pumps when it needs to. If the output voltage is at or above 3.3V, the pump is turned off and supply current is minimized. While in this rest state, output current is supplied by the charge on the output capacitor. As charge is pulled off the output capacitor, the output voltage will steadily fall until it droops below 3.3V, at which time the pump reactivates and output voltage is boosted. With PFM, the LM2760 requires very little supply current "overhead": the input current is generally only slightly above what is required to deliver power to the output. This mode of operation allows the LM2760 to maximize total solution efficiency.

### DOUBLER MODE

When in doubler mode, the LM2760 operates as a regulated switched capacitor voltage doubler. A two-phase non-overlapping clock generated internally controls the operation of the doubler. During the charge phase ( $\phi 1$ ), the flying capacitor ( $C_{FLY}$ ) is connected between the input and ground through internal pass-transistor switches (S1 and S2) and is charged to the input voltage. In the pump phase that follows ( $\phi 2$ ), the flying capacitor is connected between the input and output through similar switches (S3 and S4). Stacked atop the input, the charge of the flying capacitor boosts the output voltage and supplies the load current.

### PASS MODE

Pass mode of the LM2760 is implemented to improve efficiency at higher input voltages ( $> 3.4V$  typ.) where voltage boost is not required. In this mode of operation, switches S1 and S2 are on continuously, and switch S4 is always off. Resistance of switch S1 is increased in this mode to optimize performance. Output voltage regulation is achieved by applying a PFM clock to switch S3.

### NO-LOAD OPERATION

The minimal supply-current overhead of the LM2760 is most apparent, and beneficial, when the LM2760 is operating unloaded. With zero output current, supply current of the LM2760 is only 10 $\mu A$  (typ). There are two components to this 10 $\mu A$  input current (listed as  $I_{IN}$  in the Electrical Characteristics): quiescent current ( $I_Q$ ) and time-averaged pump current. Quiescent current is the steady-state DC current consumed by the LM2760 internal circuitry, and is typically 6 $\mu A$  when the part is unloaded. This is best observed by mea-

suring the input current of the part while forcing the voltage on the output slightly above 3.3V (ensures the pump will not activate: see below).

Even when output current of the LM2760 is zero, the pump must occasionally be activated to keep the output voltage from drooping. There is a resistor divider internal to the LM2760 that is part of the regulation feedback loop, and is connected to  $V_{OUT}$ . Current through these resistors slowly pulls charge from the output capacitor when the LM2760 is in its rest state. The LM2760 must occasionally activate the pump to restore charge to the output capacitor, thus keeping the output voltage at the desired level. With a high-quality 10 $\mu F$  ceramic output capacitor (ensures capacitor current leakage is minimal), the pump is only activated typically once every 2 seconds. When the input current of these bursts are averaged over time, they contribute only 4 $\mu A$  to the total unloaded supply current of the LM2760.

The very low input current when the part is virtually unloaded makes the LM2760 an excellent converter for generating low-power keep-alive voltage rails.

### STARTUP

When voltage is first connected to the input of the LM2760, the output voltage is typically significantly less than the input voltage, placing the part in pass mode. Pass mode, with the increased resistance of switch S1, provides a controlled start-up that limits input inrush current. Turn-on time of the part, the time it takes for the output voltage to establish, is typically 1ms when  $V_{IN} = 3.0V$ .

### THERMAL SHUTDOWN

To protect itself from damage caused by overheating, the LM2760 implements a thermal shutdown mechanism. When the junction temperature rises to 150 $^{\circ}C$  (typ.), the part switches itself into shutdown mode. The LM2760 releases thermal shutdown when the junction temperature of the part is reduced below 130 $^{\circ}C$  (typ.). Thermal shutdown is most often triggered by self-heating, which occurs when there is excessive power dissipation in the device and/or insufficient thermal dissipation. When self-heating causes thermal shutdown, thermal cycling usually occurs. Thermal cycling is the repeating process where the part self-heats, enters thermal shutdown (where internal power dissipation is practically zero), cools, turns-on, and then heats up again to the thermal shutdown threshold. Thermal cycling is recognized by a pulsing output voltage and can be stopped by reducing the internal power dissipation (reduce output current or input voltage) or the ambient temperature.

### SHORT CIRCUIT PROTECTION

The LM2760 contains short circuit protection circuitry that protects the device from damage in the event of output current and/or output shorts to ground. Current is limited to 170mA (typ.) when the output is shorted directly to ground ( $V_{IN} = 3.0V$ ). When the LM2760 output is shorted, power dissipation in the device is likely to be quite high, especially when higher input voltages are present. In this event, thermal cycling should be expected (see "Thermal Shutdown" section).

## Application Information

### OUTPUT VOLTAGE RIPPLE

The magnitude of the voltage ripple on the output of the LM2760 is highly dependent on application conditions: output current and output capacitor properties, specifically. This



## Application Information (Continued)

is illustrated in *Figure 1*, which graphs of output voltage ripple versus input voltage for a few different output capacitor values.

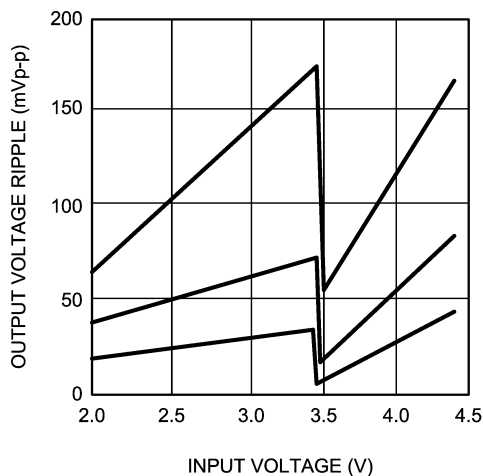

20044306

**FIGURE 1. Output Voltage Ripple vs. Input Voltage**  
( $T_A = 25^\circ\text{C}$ )

$I_{\text{OUT}} = 10\text{mA}$ ,  $T_A = 25^\circ\text{C}$

Top:  $C_{\text{OUT}} = 4.7\mu\text{F}$

Mid:  $C_{\text{OUT}} = 10\mu\text{F}$

Bottom:  $C_{\text{OUT}} = 22\mu\text{F}$

In addition to the amount of output capacitance present, the ESR of the output capacitor also affects output voltage ripple. A low-ESR ceramic capacitor is recommended on the output to keep output voltage ripple low. Placing multiple capacitors in parallel can reduce ripple significantly, both by increasing capacitance and reducing ESR. When capacitors are in parallel, ESR is in parallel as well. The effective net ESR is determined according to the properties of parallel resistance. Two identical capacitors in parallel have twice the capacitance and half the ESR as compared to a single capacitor of the same make. On a similar note, if a large-value, high-ESR capacitor (tantalum, for example) is to be used as the primary output capacitor, the net output ESR can be significantly reduced by placing a low-ESR ceramic capacitor in parallel with this primary output capacitor.

### CAPACITORS

The LM2760 requires 3 external capacitors for proper operation. Surface-mount multi-layer ceramic capacitors are recommended. These capacitors are small, inexpensive and have very low equivalent series resistance ( $\leq 10\text{m}\Omega$  typ.). Tantalum capacitors, OS-CON capacitors, and aluminum electrolytic capacitors generally are not recommended for use with the LM2760 due to their high ESR, as compared to ceramic capacitors.

For most applications, ceramic capacitors with X7R or X5R temperature characteristic are preferred for use with the LM2760. These capacitors have tight capacitance tolerance (as good as  $\pm 10\%$ ), hold their value over temperature (X7R:  $\pm 15\%$  over  $-55^\circ\text{C}$  to  $+125^\circ\text{C}$ ; X5R:  $\pm 15\%$  over  $-55^\circ\text{C}$  to  $+85^\circ\text{C}$ ), and typically have little voltage coefficient. Capacitors with Y5V and/or Z5U temperature characteristic are generally not recommended. These types of capacitors typically have wide capacitance tolerance ( $+80\%$ ,  $-20\%$ ),

vary significantly over temperature (Y5V:  $+22\%$ ,  $-82\%$  over  $-35^\circ\text{C}$  to  $+85^\circ\text{C}$ ; Z5U:  $+22\%$ ,  $-56\%$  over  $-10^\circ\text{C}$  to  $+85^\circ\text{C}$ ), and have poor voltage coefficients. Under some conditions, a nominally  $1\mu\text{F}$  Y5V or Z5U capacitor could have a capacitance of only  $0.1\mu\text{F}$ . Such detrimental deviation is likely to cause these Y5V and Z5U of capacitors to fail to meet the minimum capacitance requirements of the LM2760.

The table below lists some leading ceramic capacitor manufacturers.

Manufacturer	Contact Information
TDK	<a href="http://www.component.tdk.com">www.component.tdk.com</a>
AVX	<a href="http://www.avx.com">www.avx.com</a>
Murata	<a href="http://www.murata.com">www.murata.com</a>
Taiyo-Yuden	<a href="http://www.t-yuden.com">www.t-yuden.com</a>
Vishay-Vitramon	<a href="http://www.vishay.com">www.vishay.com</a>

### INPUT CAPACITORS

The input capacitor ( $C_{\text{IN}}$ ) is used as a reservoir of charge, helping to quickly transfer charge to the flying capacitor during the charge phase ( $\phi 1$ ) of operation. The input capacitor helps to keep the input voltage from drooping at the start of the charge phase, when the flying capacitor is first connected to the input, and helps to filter noise on the input pin that could adversely affect sensitive internal analog circuitry biased off the input line. As mentioned above, an X7R/X5R ceramic capacitor is recommended for use. An input capacitance of  $4.7\mu\text{F}$  is recommended. It may be possible to reduce this value in applications where the maximum output current is significantly less than  $20\text{mA}$ . A smaller input capacitance typically results in higher input voltage ripple, which may also show up as higher output voltage ripple as well.

### FLYING CAPACITORS

The flying capacitor ( $C_{\text{FLY}}$ ) transfers charge from the input to the output, providing the voltage boost of the doubler. A polarized capacitor (tantalum, aluminum electrolytic, etc.) must not be used here, as the capacitor will be reverse-biased upon start-up of the LM2760. For most applications, a  $0.1\mu\text{F}$  X7R/X5R ceramic capacitor is recommended for  $C_{\text{FLY}}$ . Smaller flying capacitance typically will reduce the output current capability of the part. The ESR also affects the output current capability of the LM2760. For optimal performance, a low-ESR ceramic capacitor ( $< 10\text{m}\Omega$  typ.) should be used. Larger flying capacitance may increase output current capability, but it comes with the drawback of typically increasing the magnitude of the output voltage ripple.

### OUTPUT CAPACITOR

Both output capacitance and ESR of the LM2760 output capacitor affect output voltage ripple. A low-ESR X7R/X5R ceramic capacitor is the capacitor of choice for the LM2760 output. An output capacitance of  $10\mu\text{F}$  is recommended for most applications. Reducing output capacitance typically increases output voltage ripple. In applications where the maximum output current is significantly less than  $20\text{mA}$ , output voltage ripple is less of a concern and it may be desirable to reduce the output capacitance.

### POWER EFFICIENCY

Efficiency of the LM2760 mirrors that of an unregulated switched capacitor converter cascaded with a linear regulator when more-than nominal output current is present ( $\geq$



## Application Information (Continued)

1mA). The simplified power model of the LM2760, in *Figure 2*, will be used to discuss power efficiency and power dissipation.

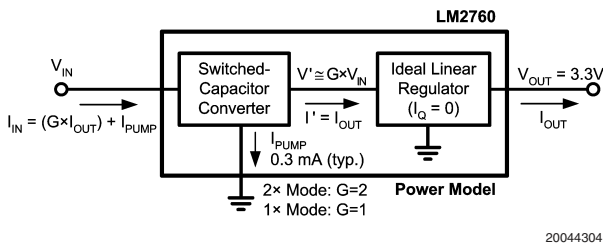

FIGURE 2. LM2760 Power Model

In calculating power efficiency, output power ( $P_{OUT}$ ) is easily determined as the product of the output current and the 3.3V output voltage. Like output current, input voltage is an application-dependent variable. The input current can be calculated using the principles of linear regulation and switched capacitor conversion. In an ideal linear regulator, the current into the circuit is equal to the current out of the circuit. The principles of power conservation mandate the ideal input current of a voltage converter must be equal to the product of the gain of the converter and the output current. When the input voltage is low ( $V_{IN} \leq 3.4V$ ) and the LM2760 is in doubler mode (2x), the gain of the converter is 2. At higher input voltages ( $V_{IN} > 3.4V$  typ.) where the LM2760 is in pass mode (1x), the gain of the converter is 1. Adding a correction factor for supply current when the pump is continuously active ( $I_{PUMP}$ , 0.3mA typ.) gives an approximation for total input current which, when combined with the other input and output parameter(s), yields the following equations for efficiency:

$$E_{2X} = \frac{P_{OUT}}{P_{IN}} = \frac{V_{OUT} \times I_{OUT}}{V_{IN} \times (2 \cdot I_{OUT} + I_{PUMP})} \quad (V_{IN} \leq 3.4V)$$

$$E_{1X} = \frac{P_{OUT}}{P_{IN}} = \frac{V_{OUT} \times I_{OUT}}{V_{IN} \times (I_{OUT} + I_{PUMP})} \quad (V_{IN} > 3.4V)$$

20044307

FIGURE 3.

A plot of efficiency versus input voltage, contained in *Figure 4*, gives a clear indication of how the pass mode improves efficiency of the part at higher input voltages. Efficiency of the part in both doubler and pass modes is inversely proportional to input voltage, highest when the input voltage is low. When the part transitions to pass mode, however, there is a boost in efficiency that is a result of the reduced input current needed for the 1x-configured converter. This multi-gain topology maximizes LM2760 efficiency over the Li-Ion battery input range: the average efficiency of the part over a 3.0V-to-4.2V input range is 75% ( $1mA \leq I_{OUT} \leq 20mA$ ).

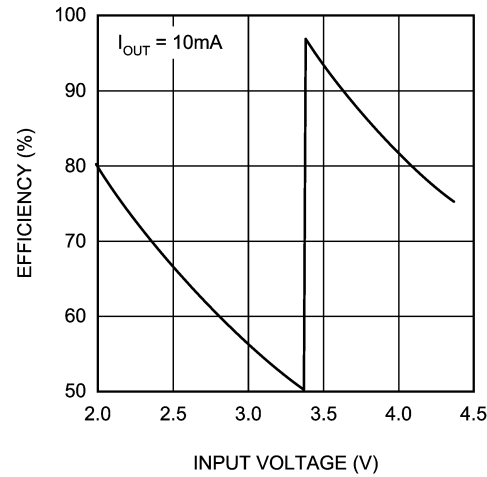

FIGURE 4. LM2760 Power Efficiency vs. Input Voltage ( $T_A = 25^\circ C$ )

Comparisons of LM2760 efficiency measurements to calculations using the above equations have shown the equations to be quite accurate approximations of actual efficiency when output currents are at or above 1mA. Under these conditions, the pump is on nearly continuously, and PFM-related rest states are infrequent. At lighter loads, however, pulse frequency modulation has a greater impact on part performance. With PFM, the part only pumps when it needs to boost the output voltage. Otherwise, it idles in a low-current rest mode. PFM reduces the input current of the part (effectively reducing  $I_{PUMP}$ ), improving the efficiency of the part at lighter loads.

### POWER DISSIPATION

LM2760 power dissipation ( $P_D$ ) is calculated simply by subtracting output power from input power. Maximum power dissipation of the LM2760 occurs at the high end of the doubler mode ( $V_{IN} = 3.4V$ ). The following equation can be used to estimate power dissipation of the LM2760 when in doubler mode:

$$P_{D-2X} = P_{IN} - P_{OUT} = [V_{IN} \times (2 \cdot I_{OUT} + I_{PUMP})] - [V_{OUT} \times I_{OUT}]$$

where  $I_{PUMP}$  is the supply current when the pump is continuously active (0.3mA typ.).

Neglecting conditions outside the specified operating ratings, maximum power dissipation of the LM2760 is approximately 70mW ( $V_{IN} \approx 3.4V$ ,  $I_{OUT} = 20mA$ ,  $I_{PUMP} = 0.3mA$ ). When the junction-to-ambient thermal resistance of the LM2760 in the application is  $220^\circ C/W$  (matches JEDEC JESD51-3), power dissipation results in a  $15^\circ C$  elevation above ambient in the junction temperature of the part. Thus, when the ambient temperature is  $85^\circ C$ , the junction temperature of the LM2760 under these conditions will be  $100^\circ C$ . LM2760 performance limits are guaranteed over a junction temperature range of  $0^\circ C$  to  $+70^\circ C$ . The LM2760 must be operated with a junction temperature within this range for the guaranteed performance limits listed in this datasheet to apply.

**Physical Dimensions** inches (millimeters)  
unless otherwise noted

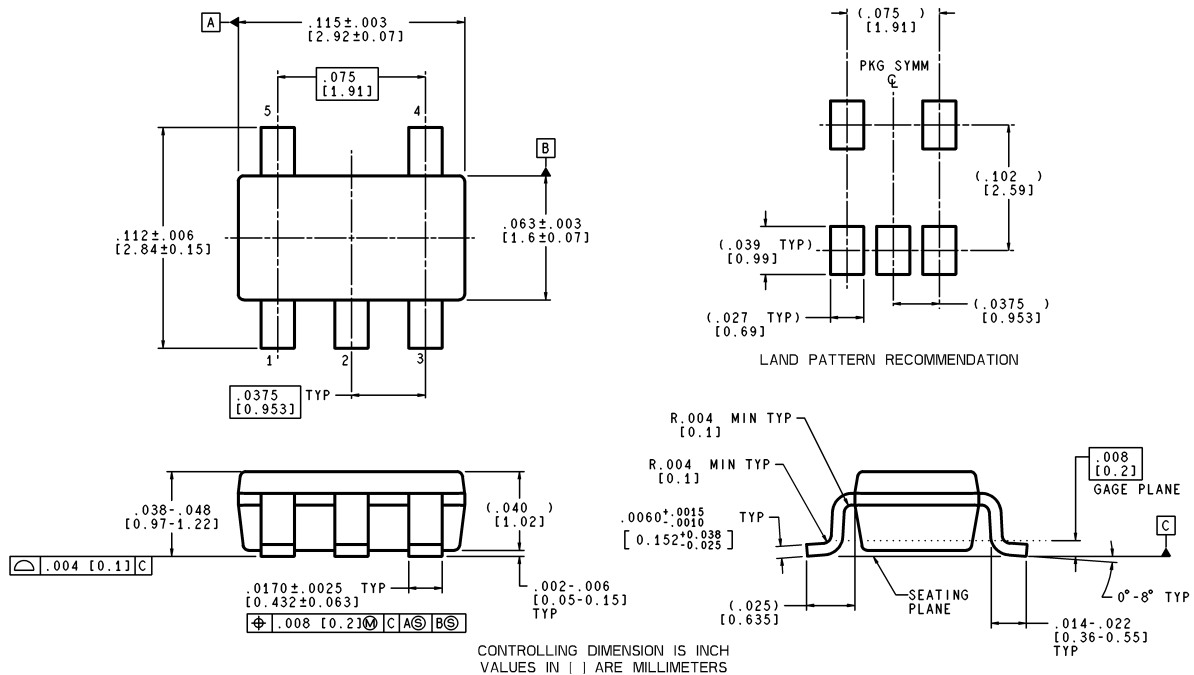

MF05A (Rev A)

**5 Lead Small Outline Package (SOT-23-5)  
MS05A**

**LIFE SUPPORT POLICY**

NATIONAL'S PRODUCTS ARE NOT AUTHORIZED FOR USE AS CRITICAL COMPONENTS IN LIFE SUPPORT DEVICES OR SYSTEMS WITHOUT THE EXPRESS WRITTEN APPROVAL OF THE PRESIDENT AND GENERAL COUNSEL OF NATIONAL SEMICONDUCTOR CORPORATION. As used herein:

1. Life support devices or systems are devices or systems which, (a) are intended for surgical implant into the body, or (b) support or sustain life, and whose failure to perform when properly used in accordance with instructions for use provided in the labeling, can be reasonably expected to result in a significant injury to the user.
2. A critical component is any component of a life support device or system whose failure to perform can be reasonably expected to cause the failure of the life support device or system, or to affect its safety or effectiveness.

**National Semiconductor Corporation**  
Americas  
Email: support@nsc.com

www.national.com

**National Semiconductor Europe**  
Fax: +49 (0) 180-530 85 86  
Email: europe.support@nsc.com  
Deutsch Tel: +49 (0) 69 9508 6208  
English Tel: +44 (0) 870 24 0 2171  
Français Tel: +33 (0) 1 41 91 8790

**National Semiconductor Asia Pacific Customer Response Group**  
Tel: 65-2544466  
Fax: 65-2504466  
Email: ap.support@nsc.com

**National Semiconductor Japan Ltd.**  
Tel: 81-3-5639-7560  
Fax: 81-3-5639-7507