

# Agilent HLMP-SL11, HLMP-RL11, HLMP-SD11, HLMP-RD11, HLMP-RB11, HLMP-RM11 4 mm Oval Precision Optical Performance Best Value AlInGaP and InGaN Lamps Data Sheet

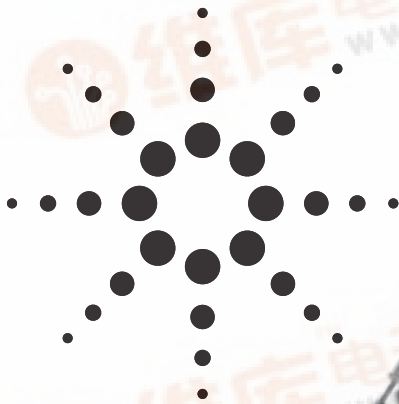

## Description

These Precision Optical Performance Oval LEDs are specifically designed for Full Color/ Video and Passenger Information signs. The Oval shaped radiation pattern (60° x 120°) and high luminous intensity ensure that these devices are excellent for wide field of view outdoor applications where a wide viewing angle and readability in sunlight are essential. These lamps have very smooth, matched radiation patterns ensuring consistent color mixing in full color applications, message uniformity across the viewing angle of the sign.

High efficiency LED materials are used in these lamps: Higher performance of Aluminum Indium Gallium Phosphide (AlInGaP II) for Red and Amber color and Indium Gallium Nitride (InGaN) for Blue and Green. Each lamp is made with an advanced optical grade epoxy offering superior high temperature and high moisture resistance in outdoor applications. The package epoxy contains both UV-A and UV-B inhibitors to reduce the effects of long term exposure to direct sunlight.

Designers can select parallel or perpendicular orientation. Both lamps are available in tinted version.

## Features

- Well-defined spatial radiation pattern
- Viewing angles:  
Major axis 120°  
Minor axis 60°
- High luminous output
- AllInGaP II (brightest) intensity level
- Colors:  
472 nm blue  
526 nm green  
630 nm red  
592 nm amber
- Superior resistance to moisture
- UV resistant epoxy

## Benefits

- Viewing angle designed for wide field of view application
- Superior performance in outdoor environments

## Applications

- Full color signs

**CAUTION:** The Blue and Green LEDs are Class 1 ESD sensitive. Please observe appropriate precautions during handling and processing. Refer to Agilent Application Note AN-1142 for additional details.

### Selection Guide for AlInGaP II

Part Number	Color and Dominant Wavelength $\lambda_d$ (nm) Typ.	Luminous Intensity, $I_v$ (mcd) Min.	Leads with Stand-Offs	Leadframe Orientation	Package Drawing
HLMP-SL11-H0000	Amber 592	180	Yes	Perpendicular	A
HLMP-RL11-H0000	Amber 592	180	Yes	Parallel	B
HLMP-SD11-J0000	Red 630	240	Yes	Perpendicular	A
HLMP-RD11-J0000	Red 630	240	Yes	Parallel	B

### Selection Guide for InGaN

Part Number	Color and Dominant Wavelength $\lambda_d$ (nm) Typ.	Luminous Intensity, $I_v$ (mcd) Min.	Leads with Stand-Offs	Leadframe Orientation	Package Drawing
HLMP-RB11-D0000	Blue 472	65	Yes	Parallel	B
HLMP-RB11-H0000	Blue 472	180	Yes	Parallel	B
HLMP-RM11-H0000	Green 526	180	Yes	Parallel	B
HLMP-RM11-M0000	Green 526	520	Yes	Parallel	B

### Package Dimensions

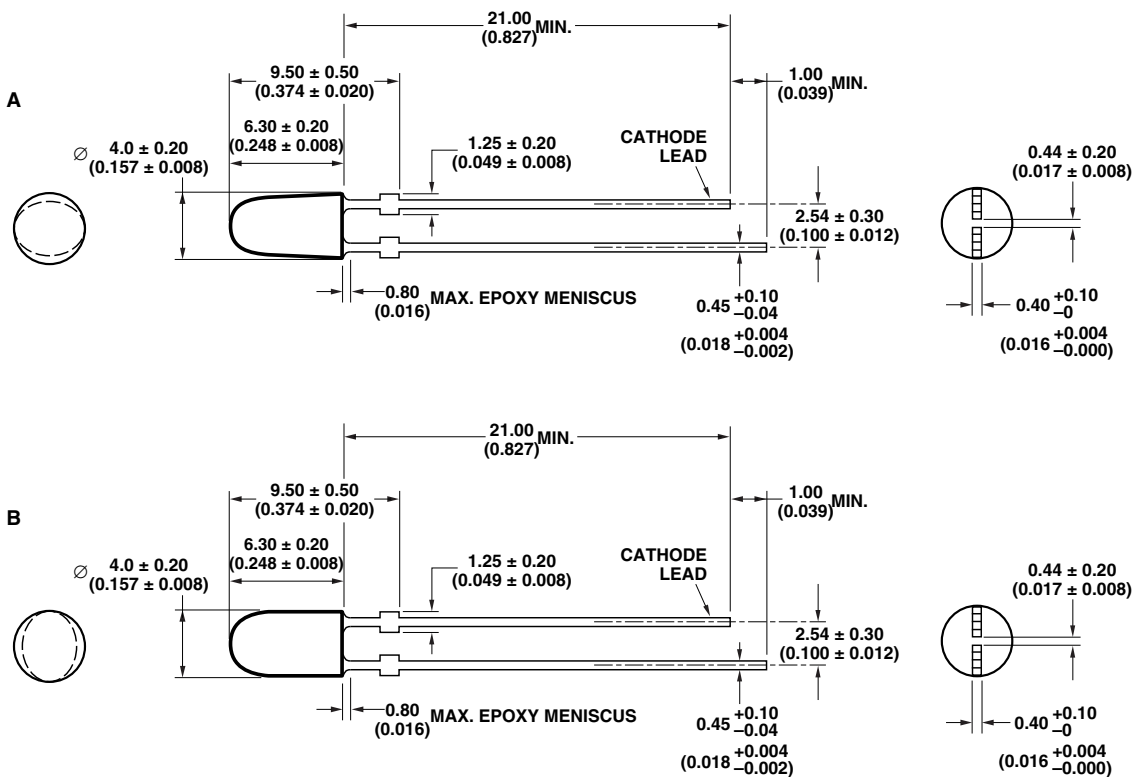

DIMENSIONS ARE IN MILLIMETERS (INCHES).

### Absolute Maximum Ratings at $T_A = 25^\circ\text{C}$

Parameter	Blue and Green	Red and Amber
DC Forward Current <sup>[1]</sup>	30 mA	50 mA
Peak Pulsed Forward Current	100 mA	100 mA
Average Forward Current	30 mA	30 mA
Reverse Voltage ( $I_R = 100 \mu\text{A}$ )	5 V	5 V
Power Dissipation	120 mW	120 mW
LED Junction Temperature	100°C	110°C
Operating Temperature Range	-40°C to +80°C	-40°C to +100°C
Storage Temperature Range	-40°C to +100°C	-40°C to +120°C
Wave Soldering Temperature	250°C for 3 sec.	250°C for 3 sec.

**Note:**

1. Derate linearly as shown in Figure 6 and 7.

### Electrical/Optical Characteristics at $T_A = 25^\circ\text{C}$

Parameter	Symbol	Min.	Typ.	Max.	Units	Test Conditions
Typical Viewing Angle						
Major	$2\theta_{1/2}$		120		deg	
Minor			60			
Forward Voltage	$V_F$				V	$I_F = 20 \text{ mA}$
Amber ( $\lambda_d = 592 \text{ nm}$ )			2.15	2.5		
Red ( $\lambda_d = 630 \text{ nm}$ )			2.00	2.5		
Blue ( $\lambda_d = 472 \text{ nm}$ )			3.5	4.0		
Green ( $\lambda_d = 526 \text{ nm}$ )			3.5	4.0		
Reverse Voltage	$V_R$				V	$I_R = 100 \mu\text{A}$
Amber, Red		5	20			
Blue, Green		5	—			$I_R = 10 \mu\text{A}$
Peak Wavelength	$\lambda_{\text{peak}}$				nm	Peak of Wavelength of Spectral Distribution at $I_F = 20 \text{ mA}$
Amber ( $\lambda_d = 592 \text{ nm}$ )			594			
Red ( $\lambda_d = 630 \text{ nm}$ )			639			
Blue ( $\lambda_d = 472 \text{ nm}$ )			470			
Green ( $\lambda_d = 526 \text{ nm}$ )		524				
Spectral Halfwidth	$\Delta\lambda_{1/2}$				nm	Wavelength Width at Spectral Distribution 1/2 Power Point at $I_F = 20 \text{ mA}$
Amber ( $\lambda_d = 592 \text{ nm}$ )			17			
Red ( $\lambda_d = 630 \text{ nm}$ )			17			
Blue ( $\lambda_d = 472 \text{ nm}$ )			35			
Green ( $\lambda_d = 526 \text{ nm}$ )		47				
Capacitance	C				pF	$V_F = 0, F = 1 \text{ MHz}$
Amber, Red			40			
Blue, Green			43			
Luminous Efficacy	$\eta_v$				lm/W	Emitted Luminous Power/Emitted Radiant Power at $I_F = 20 \text{ mA}$
Amber ( $\lambda_d = 592 \text{ nm}$ )			500			
Red ( $\lambda_d = 630 \text{ nm}$ )			155			
Blue ( $\lambda_d = 472 \text{ nm}$ )			75			
Green ( $\lambda_d = 526 \text{ nm}$ )		520				
Thermal Resistance	$R\theta_{J-PIN}$		240		°C/W	LED Junction-to-Cathode Lead

**Notes:**

1.  $2\theta_{1/2}$  is the off-axis angle where the luminous intensity is 1/2 the on-axis intensity.
2. The radiant intensity,  $I_e$  in watts per steradian, may be found from the equation  $I_e = I_v/\eta_v$  where  $I_v$  is the luminous intensity in candelas and  $\eta_v$  is the luminous efficacy in lumens/watt.
3. The luminous intensity is measured on the mechanical axis of the lamp package.
4. The optical axis is closely aligned with the package mechanical axis.
5. The dominant wavelength  $\lambda_d$  is derived from the CIE Chromaticity Diagram and represents the color of the lamp.

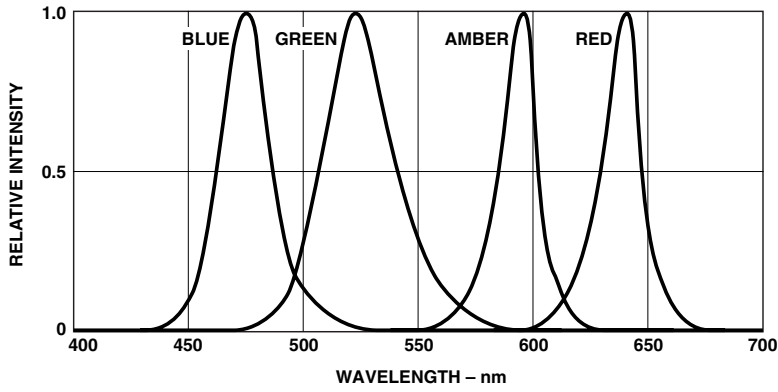

Figure 1. Relative intensity vs. wavelength.

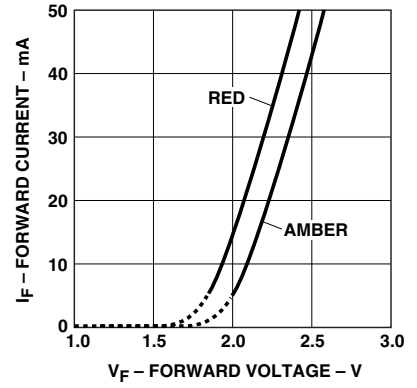

Figure 2. Amber, red forward current vs. forward voltage.

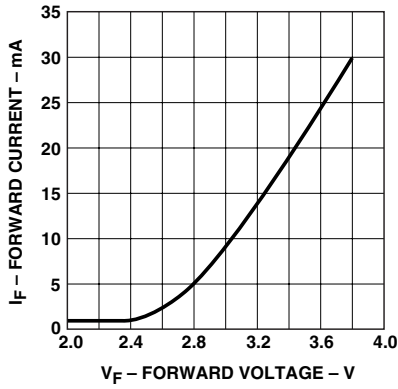

Figure 3. Blue, green forward current vs. forward voltage.

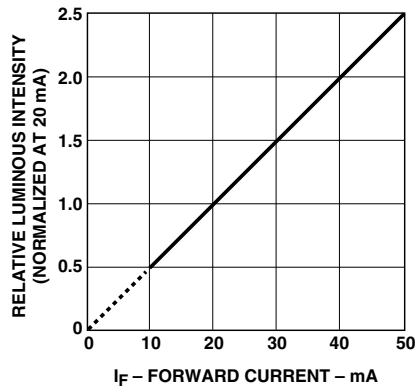

Figure 4. Amber, red relative luminous intensity vs. forward current.

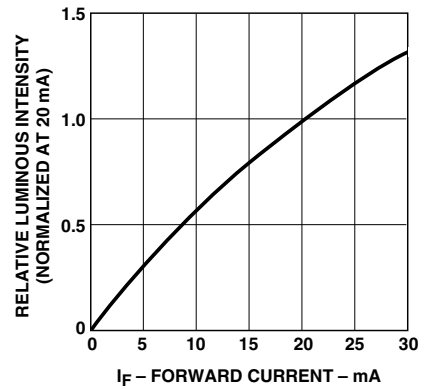

Figure 5. Blue, green relative luminous intensity vs. forward current.

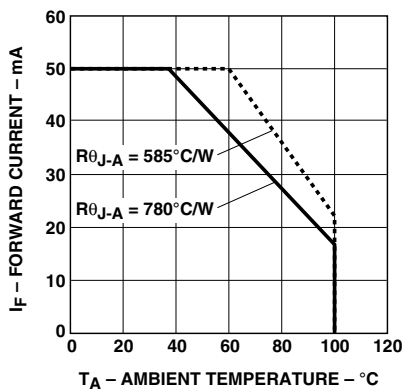

Figure 6. Amber, red maximum forward current vs. ambient temperature.

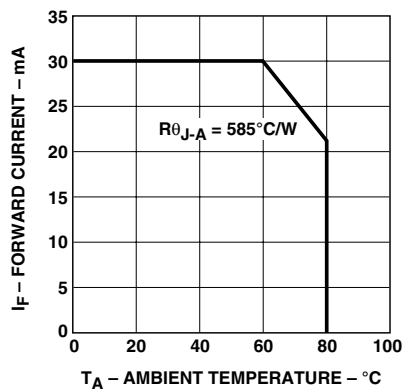

Figure 7. Blue, green maximum forward current vs. ambient temperature.

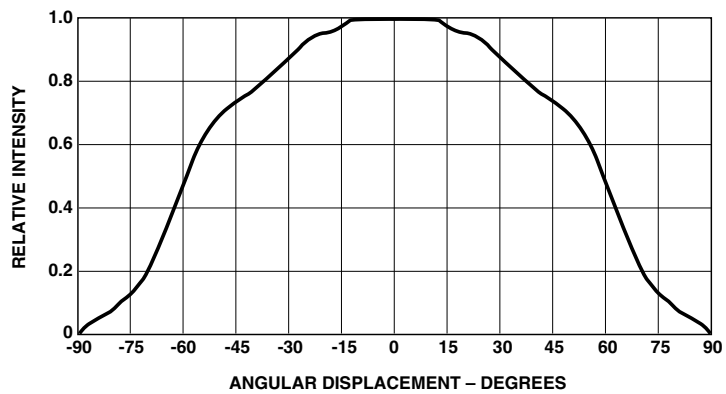

Figure 8a. Representative spatial radiation pattern for major axis.

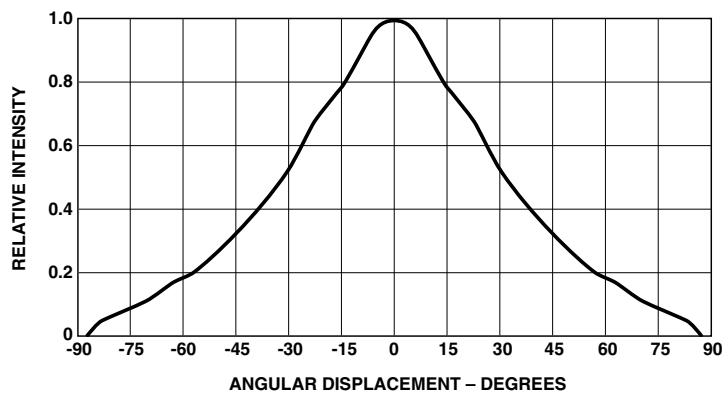

Figure 8b. Representative spatial radiation pattern for minor axis.

### Intensity Bin Limits (mcd at 20 mA)

Bin Name	Min.	Max.	Bin Name	Min.	Max.
D	65	85	J	240	310
E	85	110	K	310	400
F	110	140	L	400	520
G	140	180	M	520	680
H	180	240			

Tolerance for each bin limit is  $\pm 15\%$ .

**Note:**

1. Bin categories are established for classification of products. Products may not be available in all bin categories.

### Color Bin Limits (nm at 20 mA)

#### Blue

Bin ID	Color Range (nm)	
	Min.	Max.
1	460.0	464.0
2	464.0	468.0
3	468.0	472.0
4	472.0	476.0
5	476.0	480.0

Tolerance for each bin limit is  $\pm 2$  nm.

#### Green

Bin ID	Color Range (nm)	
	Min.	Max.
1	520.0	524.0
2	524.0	528.0
3	528.0	532.0
4	532.0	536.0
5	536.0	540.0

Tolerance for each bin limit is  $\pm 0.5$  nm.

#### Amber

Bin ID	Color Range (nm)	
	Min.	Max.
1	584.5	587.0
2	587.0	589.5
4	589.5	592.0
6	592.0	594.5

Tolerance for each bin limit is  $\pm 0.5$  nm.

**Note:**

1. All bin categories are established for classification of products. Products may not be available in all bin categories. Please contact your Agilent representatives for further information.

**[www.agilent.com/semiconductors](http://www.agilent.com/semiconductors)**

For product information and a complete list of distributors, please go to our web site.

For technical assistance call:

Americas/Canada: +1 (800) 235-0312 or  
(916) 788-6763

Europe: +49 (0) 6441 92460

China: 10800 650 0017

Hong Kong: (+65) 6756 2394

India, Australia, New Zealand: (+65) 6755 1939

Japan: (+81 3) 3335-8152 (Domestic/International), or 0120-61-1280 (Domestic Only)

Korea: (+65) 6755 1989

Singapore, Malaysia, Vietnam, Thailand,  
Philippines, Indonesia: (+65) 6755 2044

Taiwan: (+65) 6755 1843

Data subject to change.

Copyright © 2004 Agilent Technologies, Inc.

Obsoletes 5988-3135EN

August 12, 2004

5988-7311EN



**Agilent Technologies**