

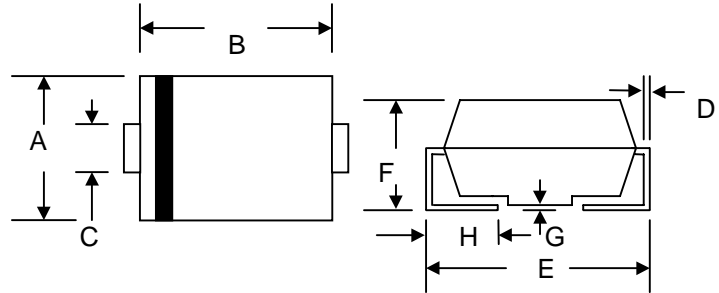

1.0A SURFACE MOUNT SUPER FAST RECTIFIER

Features

- Glass Passivated Die Construction
- Ideally Suited for Automatic Assembly
- Low Forward Voltage Drop, High Efficiency
- Surge Overload Rating to 30A Peak
- Low Power Loss
- Super-Fast Recovery Time
- Plastic Case Material has UL Flammability Classification Rating 94V-O



Mechanical Data

- Case: Low Profile Molded Plastic
- Terminals: Solder Plated, Solderable per MIL-STD-750, Method 2026
- Polarity: Cathode Band or Cathode Notch
- Marking: Type Number
- Weight: 0.093 grams (approx.)

SMB/DO-214AA		
Dim	Min	Max
A	3.30	3.94
B	4.06	4.70
C	1.91	2.11
D	0.152	0.305
E	5.08	5.59
F	2.13	2.44
G	0.051	0.203
H	0.76	1.27
All Dimensions in mm		

Maximum Ratings and Electrical Characteristics @ $T_A=25^\circ\text{C}$ unless otherwise specified

Characteristic	Symbol	ER1A	ER1B	ER1C	ER1D	ER1E	ER1G	ER1J	Unit	
Peak Repetitive Reverse Voltage	V_{RRM}	50	100	150	200	300	400	600	V	
Working Peak Reverse Voltage	V_{RWM}									
DC Blocking Voltage	V_R									
RMS Reverse Voltage	$V_{R(RMS)}$	35	70	105	140	210	280	420	V	
Average Rectified Output Current @ $T_L = 100^\circ\text{C}$	I_O	1.0							A	
Non-Repetitive Peak Forward Surge Current 8.3ms Single half sine-wave superimposed on rated load (JEDEC Method)	I_{FSM}	30							A	
Forward Voltage @ $I_F = 1.0\text{A}$	V_{FM}	0.95				1.25		1.7	V	
Peak Reverse Current @ $T_A = 25^\circ\text{C}$ At Rated DC Blocking Voltage @ $T_A = 100^\circ\text{C}$	I_{RM}	5.0				500				μA
Reverse Recovery Time (Note 1)	t_{rr}	35								nS
Typical Junction Capacitance (Note 2)	C_j	10								pF
Typical Thermal Resistance (Note 3)	$R_{\theta JL}$	34								K/W
Operating and Storage Temperature Range	T_j, T_{STG}	-65 to +150							$^\circ\text{C}$	

Note: 1. Measured with $I_F = 0.5\text{A}$, $I_R = 1.0\text{A}$, $I_{rr} = 0.25\text{A}$,
 2. Measured at 1.0 MHz and applied reverse voltage of 4.0 V DC.
 3. Mounted on P.C. Board with 8.0mm² land area.

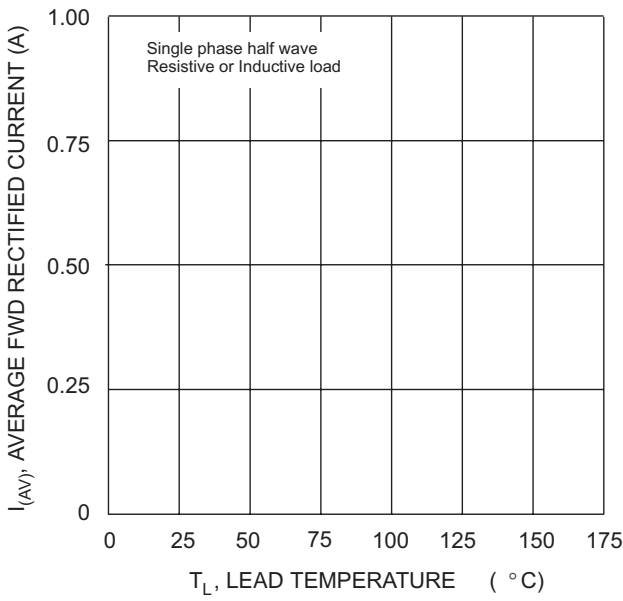

Fig. 1 Forward Current Derating Curve

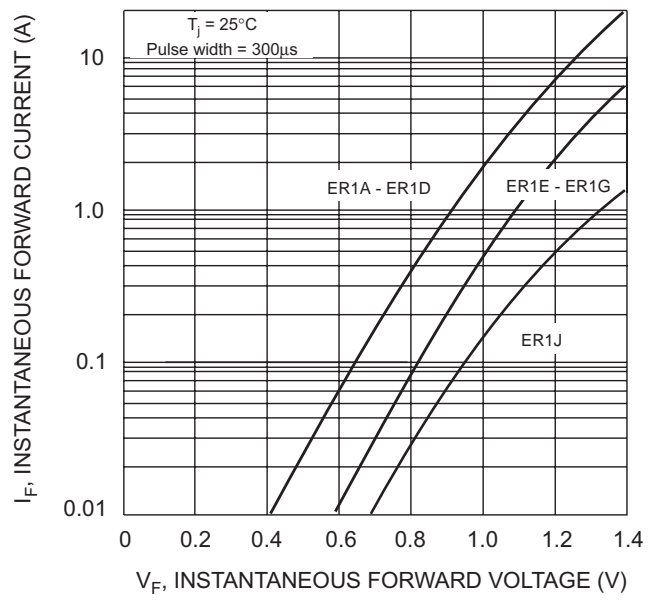

Fig. 2 Typical Forward Characteristics

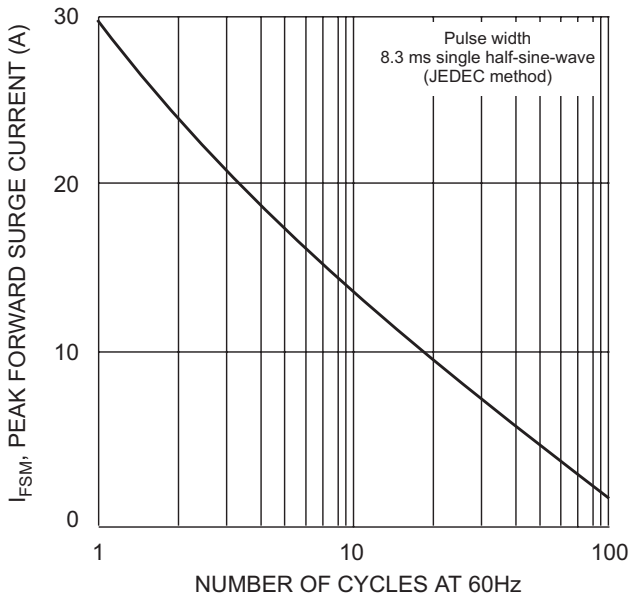

Fig. 3 Peak Forward Surge Current

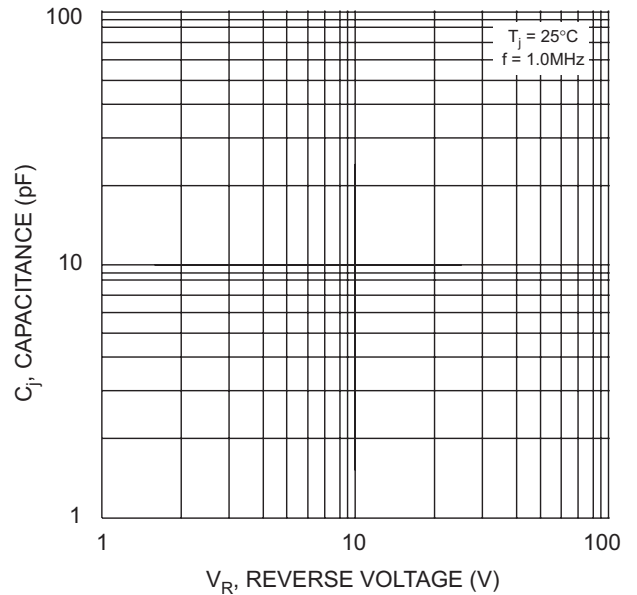
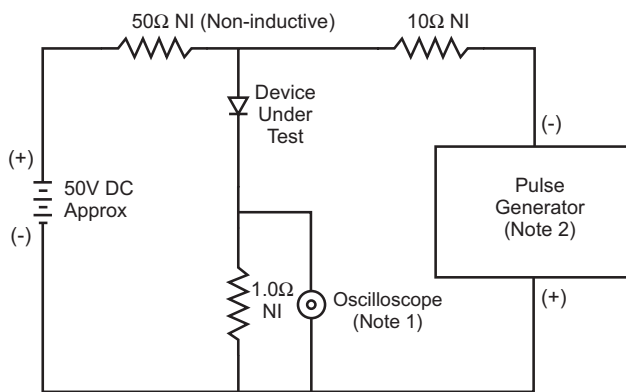

Fig. 4 Typical Junction Capacitance



- Notes:
1. Rise Time = 7.0ns max. Input Impedance = 1.0MΩ, 22pF.
 2. Rise Time = 10ns max. Input Impedance = 50Ω.

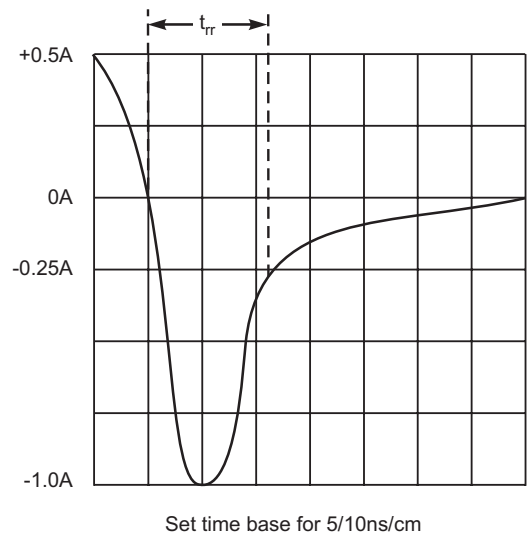

Fig. 5 Reverse Recovery Time Characteristic and Test Circuit