

General Description

The AOD482/AOI482 combines advanced trench MOSFET technology with a low resistance package to provide extremely low $R_{DS(ON)}$. This device is ideal for boost converters and synchronous rectifiers for consumer, telecom, industrial power supplies and LED backlighting.

Features

V_{DS}	100V
I_D (at $V_{GS}=10V$)	32A
$R_{DS(ON)}$ (at $V_{GS}=10V$)	< 37m Ω
$R_{DS(ON)}$ (at $V_{GS} = 4.5V$)	< 42m Ω

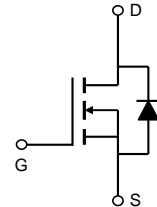

Absolute Maximum Ratings $T_A=25^\circ\text{C}$ unless otherwise noted

Parameter	Symbol	Maximum	Units
Drain-Source Voltage	V_{DS}	100	V
Gate-Source Voltage	V_{GS}	± 20	V
Continuous Drain Current	I_D	$T_C=25^\circ\text{C}$	32
		$T_C=100^\circ\text{C}$	22
Pulsed Drain Current ^C	I_{DM}	70	A
Continuous Drain Current	I_{DSM}	$T_A=25^\circ\text{C}$	5
		$T_A=70^\circ\text{C}$	4
Avalanche Current ^C	I_{AS}, I_{AR}	35	A
Avalanche energy $L=0.1\text{mH}$ ^C	E_{AS}, E_{AR}	61	mJ
Power Dissipation ^B	P_D	$T_C=25^\circ\text{C}$	100
		$T_C=100^\circ\text{C}$	50
Power Dissipation ^A	P_{DSM}	$T_A=25^\circ\text{C}$	2.5
		$T_A=70^\circ\text{C}$	1.6
Junction and Storage Temperature Range	T_J, T_{STG}	-55 to 175	$^\circ\text{C}$

Thermal Characteristics

Parameter	Symbol	Typ	Max	Units
Maximum Junction-to-Ambient ^A $t \leq 10\text{s}$	$R_{\theta JA}$	14.2	20	$^\circ\text{C}/\text{W}$
Maximum Junction-to-Ambient ^{A D} Steady-State		39	50	$^\circ\text{C}/\text{W}$
Maximum Junction-to-Case Steady-State	$R_{\theta JC}$	0.8	1.5	$^\circ\text{C}/\text{W}$

Electrical Characteristics (T_J=25°C unless otherwise noted)

Symbol	Parameter	Conditions	Min	Typ	Max	Units
STATIC PARAMETERS						
BV _{DSS}	Drain-Source Breakdown Voltage	I _D =250μA, V _{GS} =0V	100			V
I _{DSS}	Zero Gate Voltage Drain Current	V _{DS} =100V, V _{GS} =0V T _J =55°C			1 5	μA
I _{GSS}	Gate-Body leakage current	V _{DS} =0V, V _{GS} = ±20V			100	nA
V _{GS(th)}	Gate Threshold Voltage	V _{DS} =V _{GS} I _D =250μA	1.6	2.1	2.7	V
I _{D(ON)}	On state drain current	V _{GS} =10V, V _{DS} =5V	70			A
R _{DS(ON)}	Static Drain-Source On-Resistance	V _{GS} =10V, I _D =10A T _J =125°C		30 63	37 76	mΩ
		V _{GS} =4.5V, I _D =10A		32	42	
g _{FS}	Forward Transconductance	V _{DS} =5V, I _D =10A		45		S
V _{SD}	Diode Forward Voltage	I _S =1A, V _{GS} =0V		0.7	1	V
I _S	Maximum Body-Diode Continuous Current				54	A
DYNAMIC PARAMETERS						
C _{iss}	Input Capacitance	V _{GS} =0V, V _{DS} =50V, f=1MHz	1300	1630	2000	pF
C _{oss}	Output Capacitance		70	100	130	pF
C _{rss}	Reverse Transfer Capacitance		30	50	70	pF
R _g	Gate resistance	V _{GS} =0V, V _{DS} =0V, f=1MHz	0.3	0.75	1.1	Ω
SWITCHING PARAMETERS						
Q _{g(10V)}	Total Gate Charge	V _{GS} =10V, V _{DS} =50V, I _D =10A	26	34	44	nC
Q _{g(4.5V)}	Total Gate Charge		14	18	22	nC
Q _{gs}	Gate Source Charge		4	6	8	nC
Q _{gd}	Gate Drain Charge		5	9	13	nC
t _{D(on)}	Turn-On DelayTime	V _{GS} =10V, V _{DS} =50V, R _L =5Ω, R _{GEN} =3Ω		7		ns
t _r	Turn-On Rise Time			7		ns
t _{D(off)}	Turn-Off DelayTime			29		ns
t _f	Turn-Off Fall Time			7		ns
t _{rr}	Body Diode Reverse Recovery Time	I _F =10A, dI/dt=500A/μs	22	32	42	ns
Q _{rr}	Body Diode Reverse Recovery Charge	I _F =10A, dI/dt=500A/μs	140	200	260	nC

A. The value of R_{θJA} is measured with the device mounted on 1in² FR-4 board with 2oz. Copper, in a still air environment with T_A=25°C. The Power dissipation P_{DSM} is based on R_{θJA} and the maximum allowed junction temperature of 150°C. The value in any given application depends on the user's specific board design, and the maximum temperature of 175°C may be used if the PCB allow s it.

B. The power dissipation P_D is based on T_{J(MAX)}=175°C, using junction-to-case thermal resistance, and is more useful in setting the upper dissipation limit for cases where additional heatsinking is used.

C. Repetitive rating, pulse width limited by junction temperature T_{J(MAX)}=175°C. Ratings are based on low frequency and duty cycles to keep initial T_J=25°C.

D. The R_{θJA} is the sum of the thermal impedance from junction to case R_{θJC} and case to ambient.

E. The static characteristics in Figures 1 to 6 are obtained using <300μs pulses, duty cycle 0.5% max.

F. These curves are based on the junction-to-case thermal impedance which is measured with the device mounted to a large heatsink, assuming a maximum junction temperature of T_{J(MAX)}=175°C. The SOA curve provides a single pulse rating.

G. The maximum current rating is package limited.

H. These tests are performed with the device mounted on 1 in² FR-4 board with 2oz. Copper, in a still air environment with T_A=25°C.

TYPICAL ELECTRICAL AND THERMAL CHARACTERISTICS

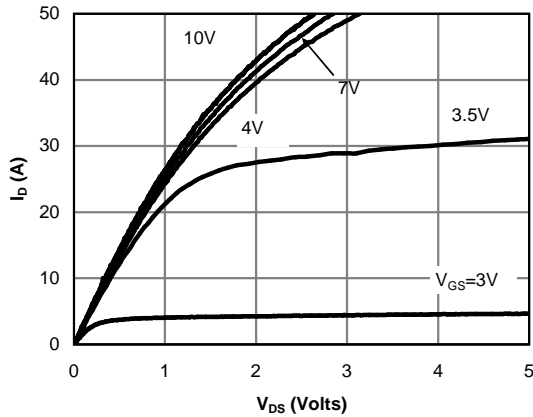

Fig 1: On-Region Characteristics (Note E)

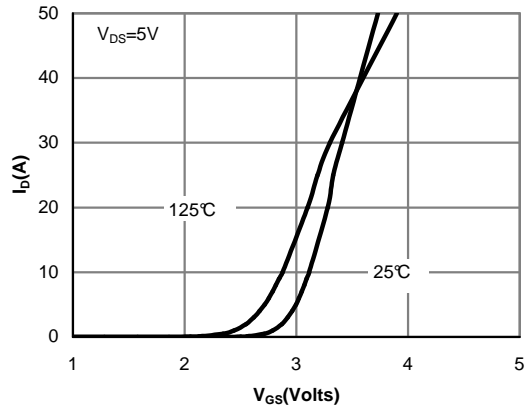

Figure 2: Transfer Characteristics (Note E)

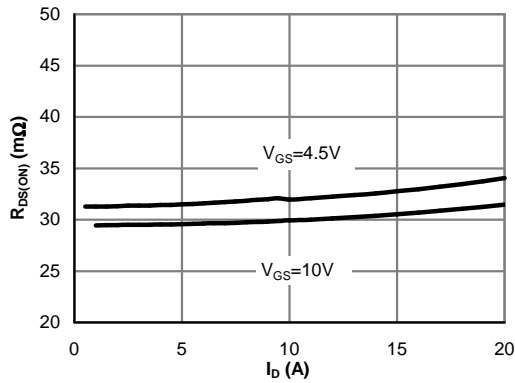

Figure 3: On-Resistance vs. Drain Current and Gate Voltage (Note E)

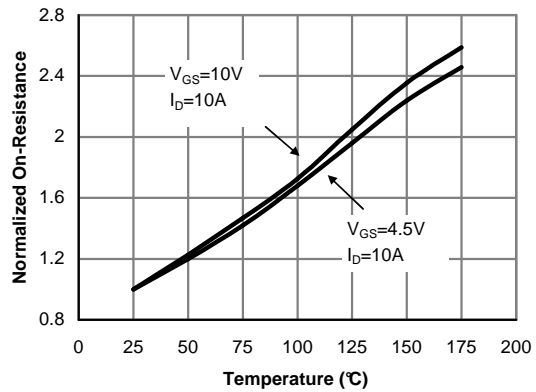

Figure 4: On-Resistance vs. Junction Temperature (Note E)

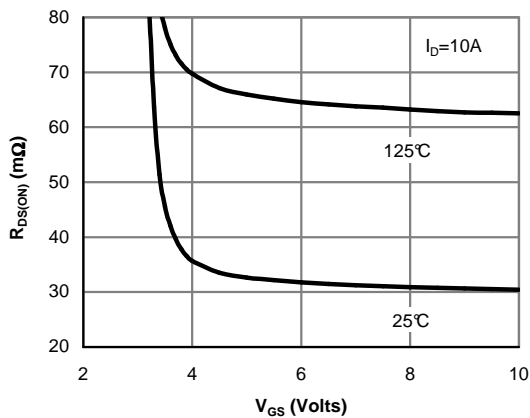

Figure 5: On-Resistance vs. Gate-Source Voltage (Note E)

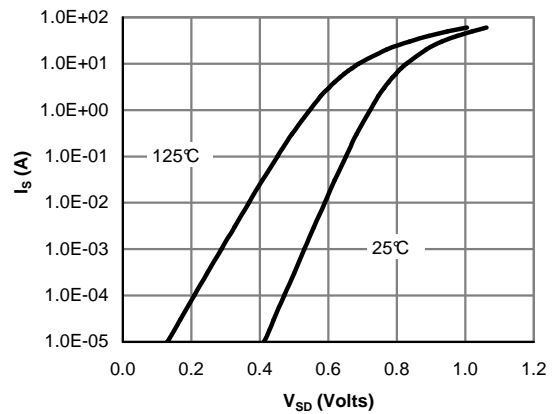

Figure 6: Body-Diode Characteristics (Note E)

TYPICAL ELECTRICAL AND THERMAL CHARACTERISTICS

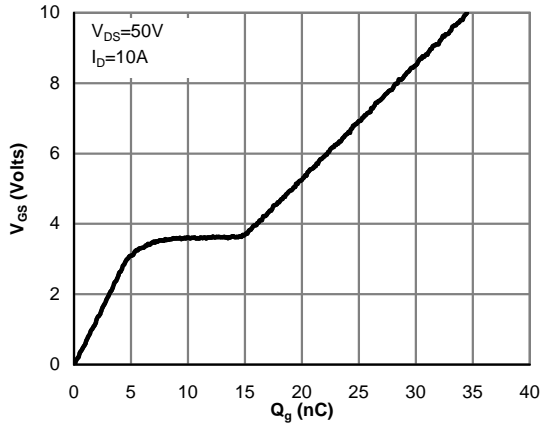

Figure 7: Gate-Charge Characteristics

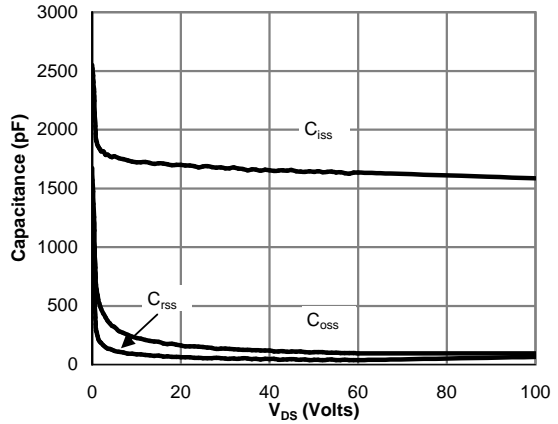

Figure 8: Capacitance Characteristics

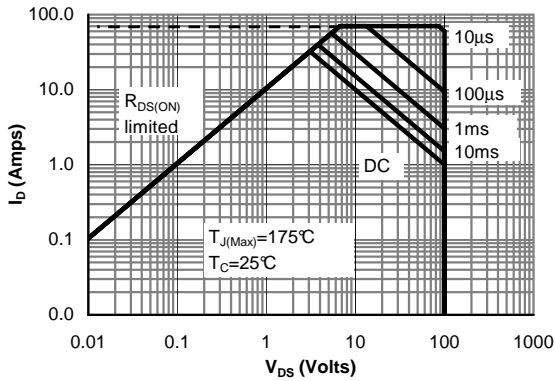

Figure 9: Maximum Forward Biased Safe Operating Area (Note F)

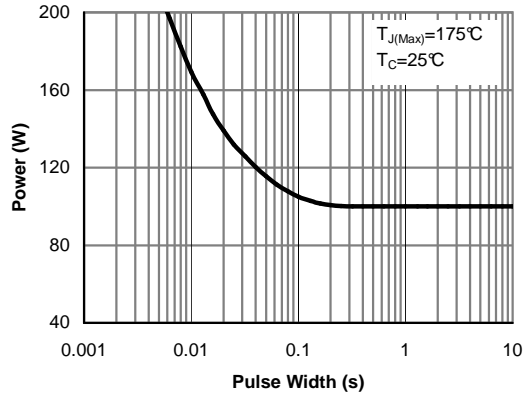

Figure 10: Single Pulse Power Rating Junction-to-Case (Note F)

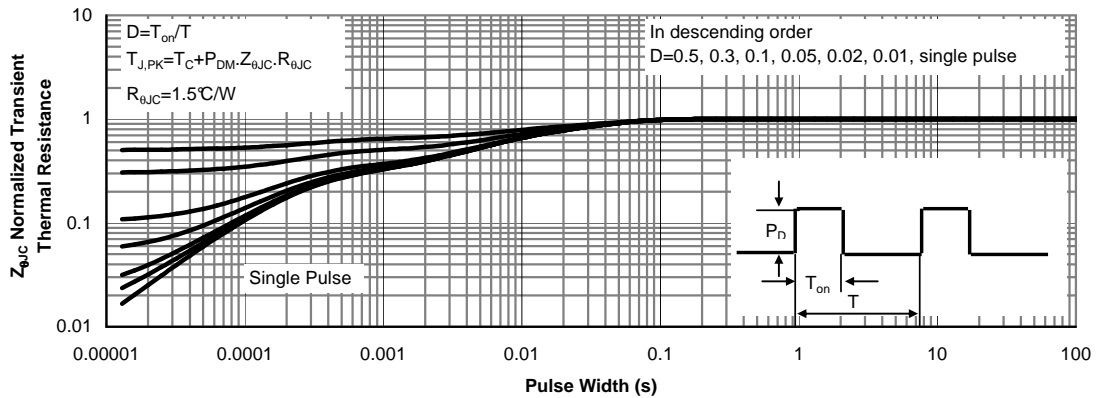

Figure 11: Normalized Maximum Transient Thermal Impedance (Note F)

TYPICAL ELECTRICAL AND THERMAL CHARACTERISTICS

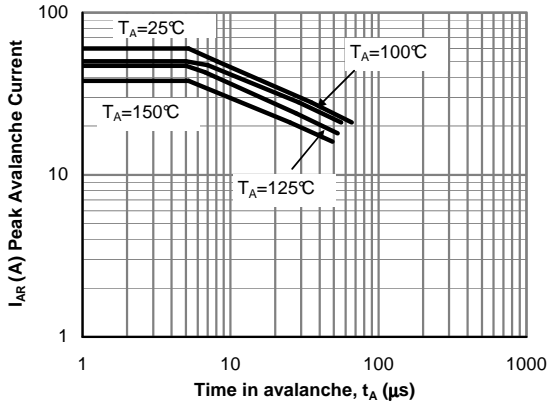

Figure 12: Single Pulse Avalanche capability (Note C)

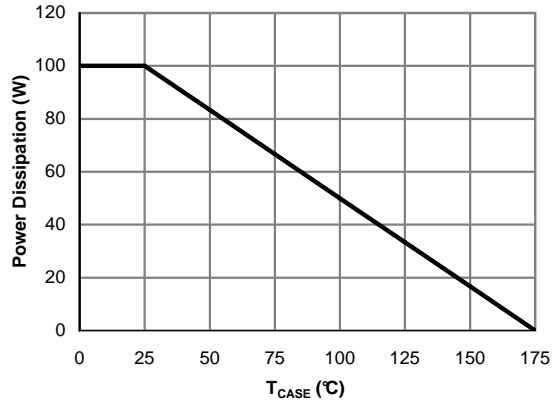

Figure 13: Power De-rating (Note F)

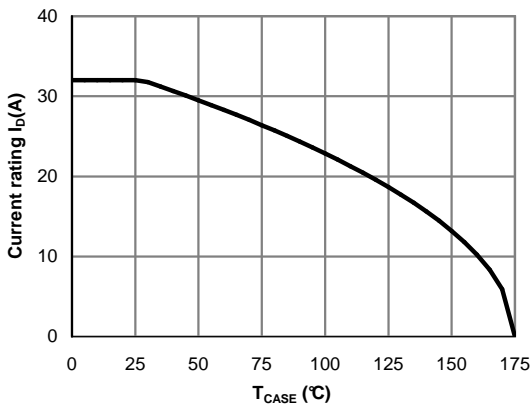

Figure 14: Current De-rating (Note F)

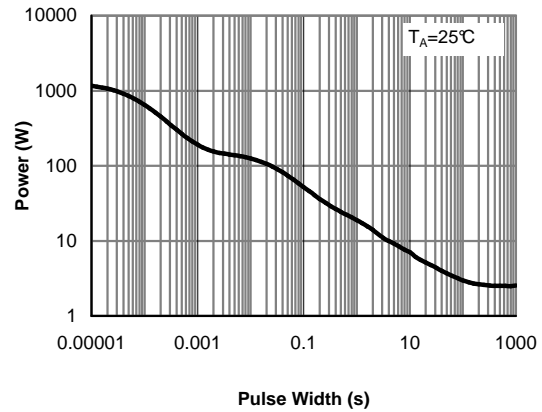

Figure 15: Single Pulse Power Rating Junction-to-Ambient (Note H)

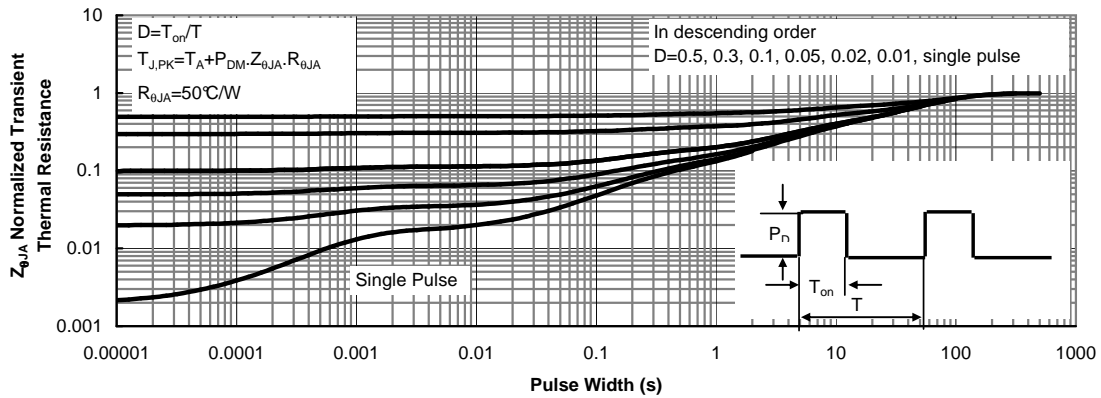
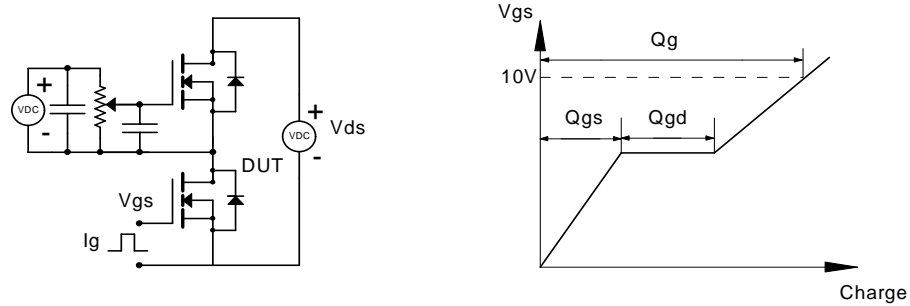
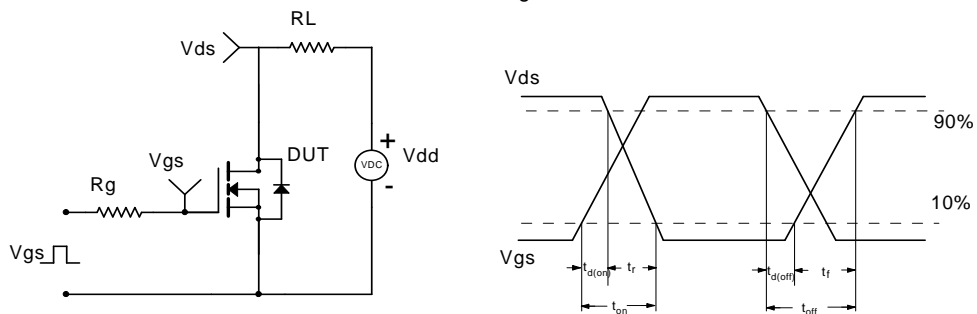

Figure 16: Normalized Maximum Transient Thermal Impedance (Note H)

Gate Charge Test Circuit & Waveform



Resistive Switching Test Circuit & Waveforms



Unclamped Inductive Switching (UIS) Test Circuit & Waveforms

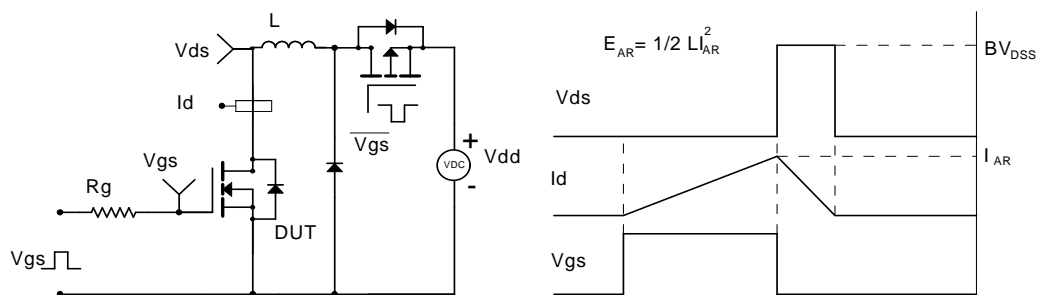

Diode Recovery Test Circuit & Waveforms

