

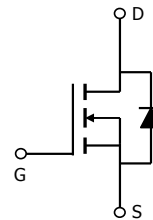
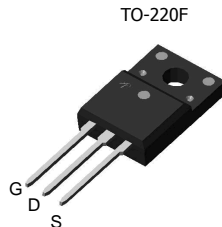
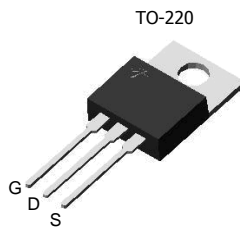
## General Description

The AOT2N60 & AOTF2N60 have been fabricated using an advanced high voltage MOSFET process that is designed to deliver high levels of performance and robustness in popular AC-DC applications.

By providing low  $R_{DS(on)}$ ,  $C_{iss}$  and  $C_{rss}$  along with guaranteed avalanche capability these parts can be adopted quickly into new and existing offline power supply designs.

## Features

$V_{DS}$	700V@150°C
$I_D$ (at $V_{GS}=10V$ )	2A
$R_{DS(ON)}$ (at $V_{GS}=10V$ )	< 4.4Ω



### Absolute Maximum Ratings $T_A=25^\circ\text{C}$ unless otherwise noted

Parameter	Symbol	AOT2N60	AOTF2N60	Units
Drain-Source Voltage	$V_{DS}$	600		V
Gate-Source Voltage	$V_{GS}$	±30		V
Continuous Drain Current	$I_D$	$T_C=25^\circ\text{C}$	2	A
		$T_C=100^\circ\text{C}$	1.7	
Pulsed Drain Current <sup>C</sup>	$I_{DM}$	8		A
Avalanche Current <sup>C</sup>	$I_{AR}$	2		A
Repetitive avalanche energy <sup>C</sup>	$E_{AR}$	60		mJ
Single pulsed avalanche energy <sup>G</sup>	$E_{AS}$	120		mJ
Peak diode recovery dv/dt	dv/dt	5		V/ns
Power Dissipation <sup>B</sup>	$P_D$	$T_C=25^\circ\text{C}$	74	W
		Derate above 25°C	0.6	
Junction and Storage Temperature Range	$T_J, T_{STG}$	-55 to 150		°C
Maximum lead temperature for soldering purpose, 1/8" from case for 5 seconds	$T_L$	300		°C

### Thermal Characteristics

Parameter	Symbol	AOT2N60	AOTF2N60	Units
Maximum Junction-to-Ambient <sup>A,D</sup>	$R_{\theta JA}$	65	65	°C/W
Maximum Case-to-sink <sup>A</sup>	$R_{\theta CS}$	0.5	--	°C/W
Maximum Junction-to-Case	$R_{\theta JC}$	1.7	4	°C/W

\* Drain current limited by maximum junction temperature.

**Electrical Characteristics (T<sub>J</sub>=25°C unless otherwise noted)**

Symbol	Parameter	Conditions	Min	Typ	Max	Units
<b>STATIC PARAMETERS</b>						
BV <sub>DSS</sub>	Drain-Source Breakdown Voltage	I <sub>D</sub> =250μA, V <sub>GS</sub> =0V, T <sub>J</sub> =25°C I <sub>D</sub> =250μA, V <sub>GS</sub> =0V, T <sub>J</sub> =150°C	600			V
BV <sub>DSS</sub> /ΔT <sub>J</sub>	Zero Gate Voltage Drain Current	I <sub>D</sub> =250μA, V <sub>GS</sub> =0V		0.56		V/°C
I <sub>DSS</sub>	Zero Gate Voltage Drain Current	V <sub>DS</sub> =600V, V <sub>GS</sub> =0V V <sub>DS</sub> =480V, T <sub>J</sub> =125°C			1 10	μA
I <sub>GSS</sub>	Gate-Body leakage current	V <sub>DS</sub> =0V, V <sub>GS</sub> =±30V			±100	nA
V <sub>GS(th)</sub>	Gate Threshold Voltage	V <sub>DS</sub> =5V, I <sub>D</sub> =250μA	3	4	4.5	V
R <sub>DS(ON)</sub>	Static Drain-Source On-Resistance	V <sub>GS</sub> =10V, I <sub>D</sub> =1A		3.6	4.4	Ω
g <sub>FS</sub>	Forward Transconductance	V <sub>DS</sub> =40V, I <sub>D</sub> =1A		3.5		S
V <sub>SD</sub>	Diode Forward Voltage	I <sub>S</sub> =1A, V <sub>GS</sub> =0V		0.79	1	V
I <sub>S</sub>	Maximum Body-Diode Continuous Current				2	A
I <sub>SM</sub>	Maximum Body-Diode Pulsed Current				8	A
<b>DYNAMIC PARAMETERS</b>						
C <sub>iss</sub>	Input Capacitance	V <sub>GS</sub> =0V, V <sub>DS</sub> =25V, f=1MHz	215	270	325	pF
C <sub>oss</sub>	Output Capacitance		23	29	35	pF
C <sub>riss</sub>	Reverse Transfer Capacitance		2.2	2.8	3.4	pF
R <sub>g</sub>	Gate resistance	V <sub>GS</sub> =0V, V <sub>DS</sub> =0V, f=1MHz	3.5	4.4	6.6	Ω
<b>SWITCHING PARAMETERS</b>						
Q <sub>g</sub>	Total Gate Charge	V <sub>GS</sub> =10V, V <sub>DS</sub> =480V, I <sub>D</sub> =2A		9.5	11.4	nC
Q <sub>gs</sub>	Gate Source Charge		1.9	2.3	nC	
Q <sub>gd</sub>	Gate Drain Charge		4.7	5.6	nC	
t <sub>D(on)</sub>	Turn-On DelayTime	V <sub>GS</sub> =10V, V <sub>DS</sub> =300V, I <sub>D</sub> =2A, R <sub>G</sub> =25Ω		17.2		ns
t <sub>r</sub>	Turn-On Rise Time		14.3		ns	
t <sub>D(off)</sub>	Turn-Off DelayTime		27		ns	
t <sub>f</sub>	Turn-Off Fall Time		17		ns	
t <sub>rr</sub>	Body Diode Reverse Recovery Time		I <sub>F</sub> =2A, di/dt=100A/μs, V <sub>DS</sub> =100V		154	185
Q <sub>rr</sub>	Body Diode Reverse Recovery Charge	I <sub>F</sub> =2A, di/dt=100A/μs, V <sub>DS</sub> =100V		0.80	1	μC

A. The value of R<sub>θJA</sub> is measured with the device in a still air environment with T<sub>A</sub>=25°C.

B. The power dissipation P<sub>D</sub> is based on T<sub>J(MAX)</sub>=150°C, using junction-to-case thermal resistance, and is more useful in setting the upper dissipation limit for cases where additional heatsinking is used.

C. Repetitive rating, pulse width limited by junction temperature T<sub>J(MAX)</sub>=150°C, Ratings are based on low frequency and duty cycles to keep initial T<sub>J</sub>=25°C.

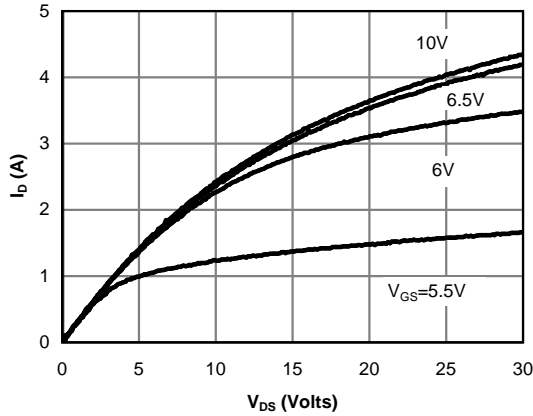
D. The R<sub>θJA</sub> is the sum of the thermal impedance from junction to case R<sub>θJC</sub> and case to ambient.

E. The static characteristics in Figures 1 to 6 are obtained using <300 μs pulses, duty cycle 0.5% max.

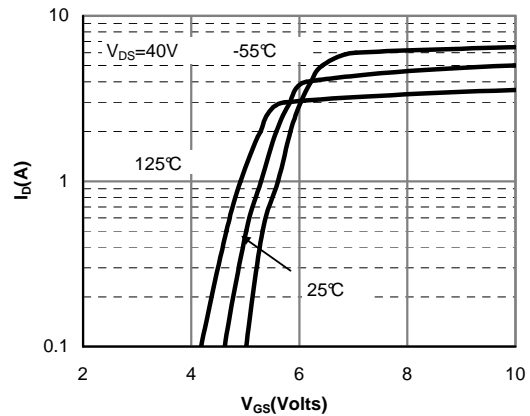
F. These curves are based on the junction-to-case thermal impedance which is measured with the device mounted to a large heatsink, assuming a maximum junction temperature of T<sub>J(MAX)</sub>=150°C. The SOA curve provides a single pulse rating g.

G. L=60mH, I<sub>AS</sub>=2A, V<sub>DD</sub>=150V, R<sub>G</sub>=25Ω, Starting T<sub>J</sub>=25°C

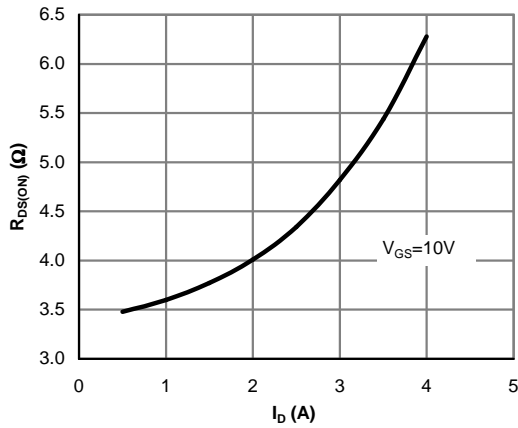
**TYPICAL ELECTRICAL AND THERMAL CHARACTERISTICS**



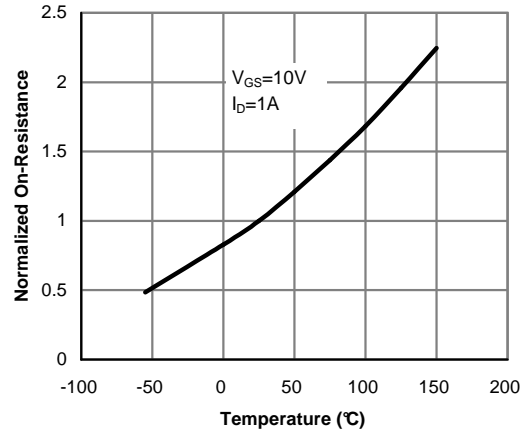
**Figure 1: On-Region Characteristics**



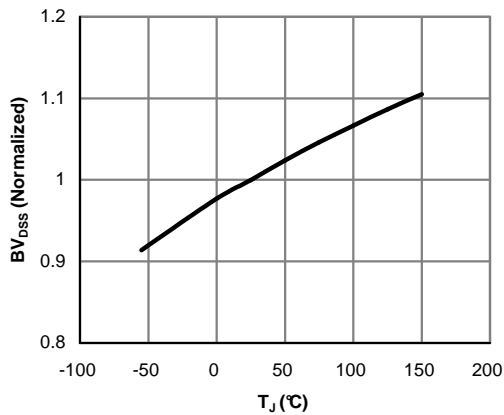
**Figure 2: Transfer Characteristics**



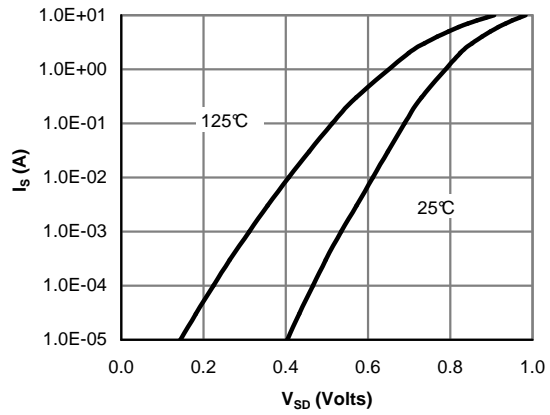
**Figure 3: On-Resistance vs. Drain Current and Gate Voltage**



**Figure 4: On-Resistance vs. Junction Temperature**

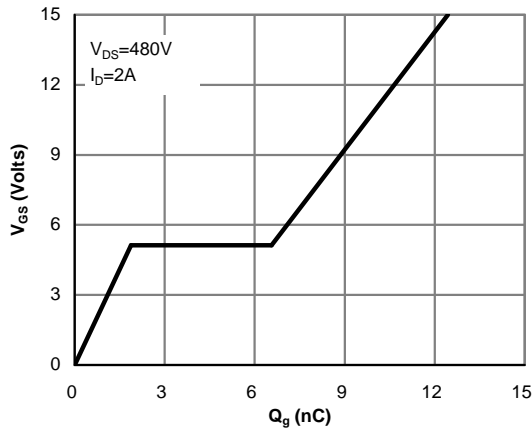


**Figure 5: Break Down vs. Junction Temperature**

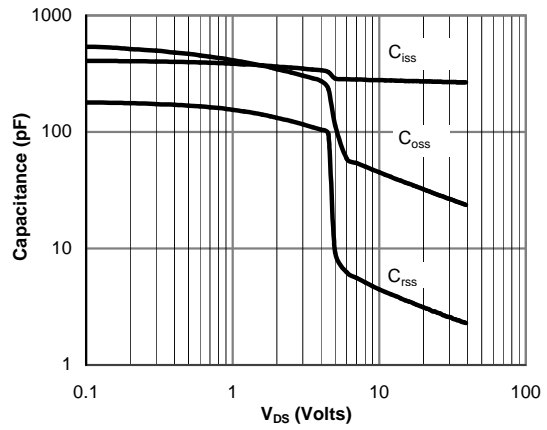


**Figure 6: Body-Diode Characteristics (Note E)**

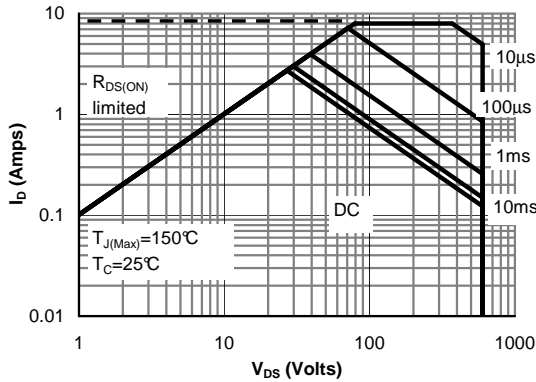
**TYPICAL ELECTRICAL AND THERMAL CHARACTERISTICS**



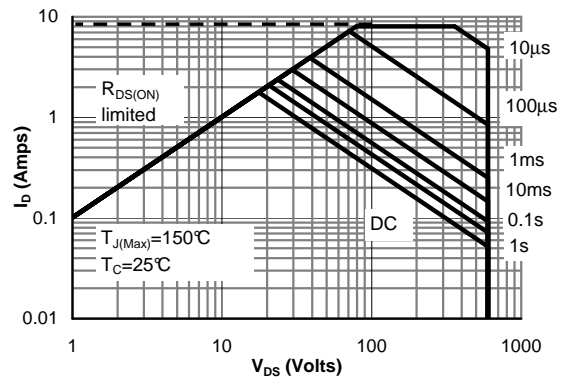
**Figure 7: Gate-Charge Characteristics**



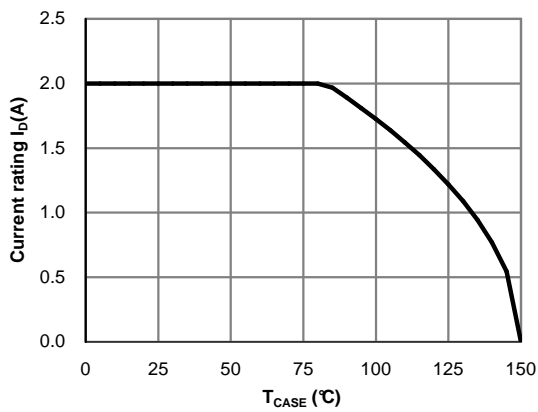
**Figure 8: Capacitance Characteristics**



**Figure 9: Maximum Forward Biased Safe Operating Area for AOT2N60 (Note F)**



**Figure 10: Maximum Forward Biased Safe Operating Area for AOTF2N60 (Note F)**



**Figure 11: Current De-rating (Note B)**

**TYPICAL ELECTRICAL AND THERMAL CHARACTERISTICS**

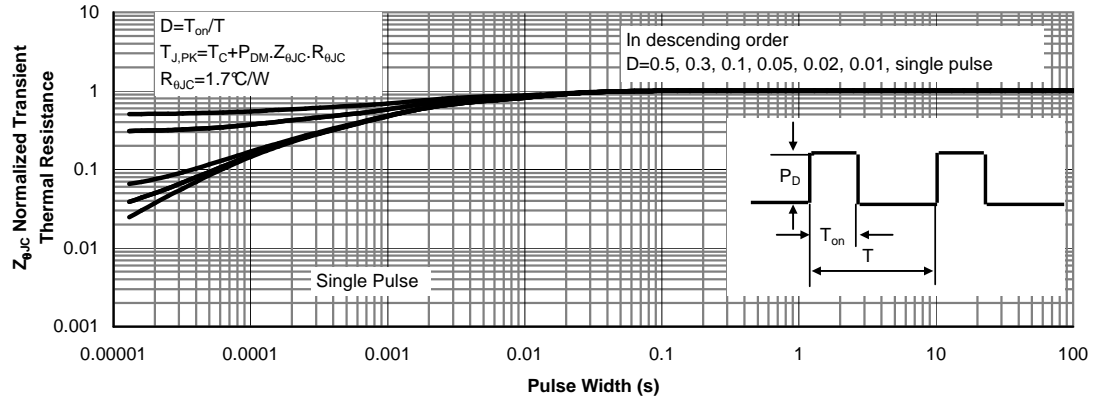


Figure 12: Normalized Maximum Transient Thermal Impedance for AOT2N60 (Note F)

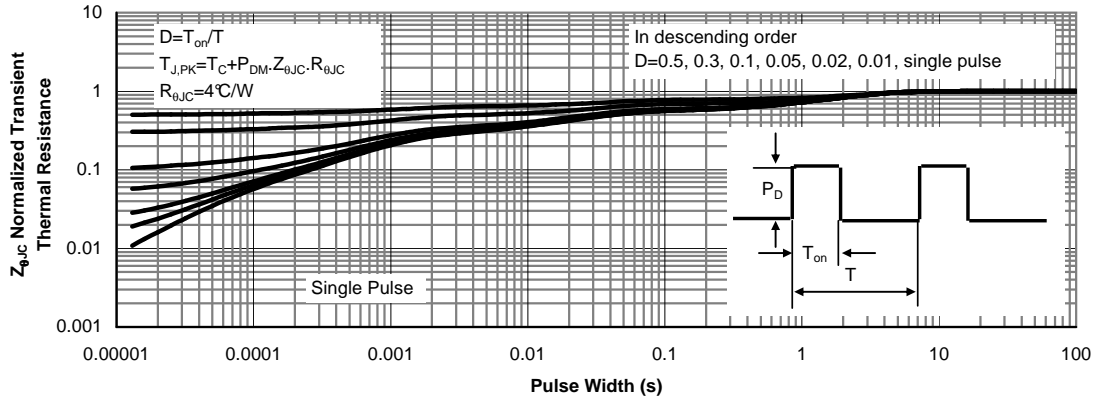
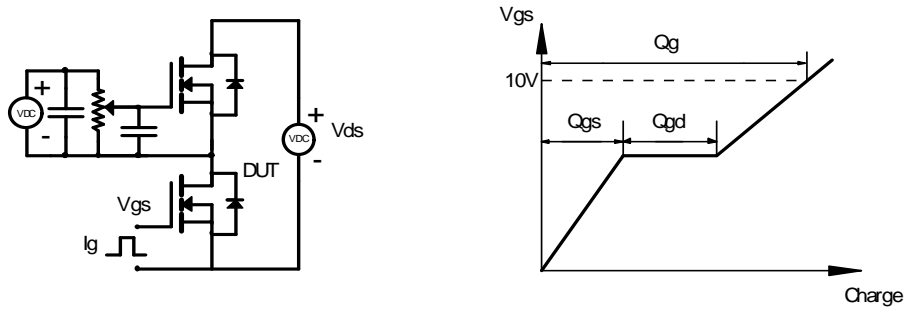
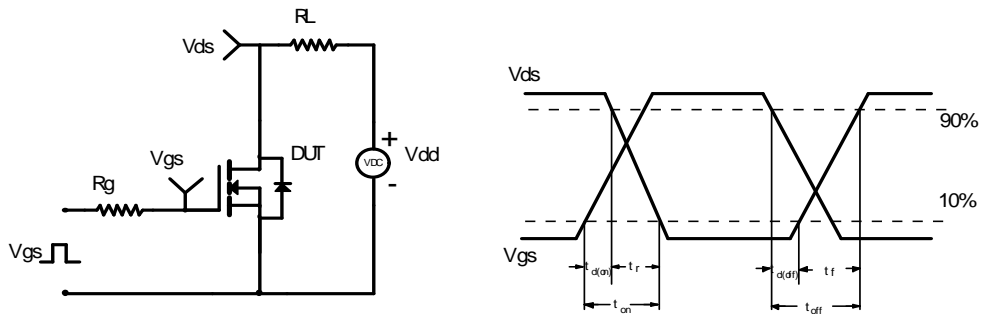


Figure 13: Normalized Maximum Transient Thermal Impedance for AOTF2N60 (Note F)

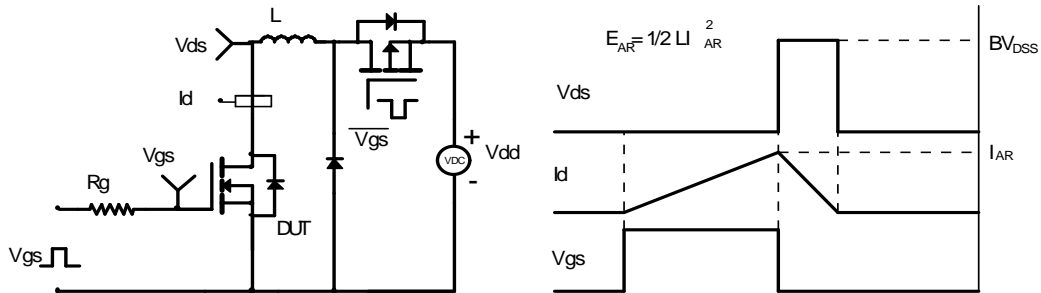
Gate Charge Test Circuit & Waveform



Resistive Switching Test Circuit & Waveforms



Unclamped Inductive Switching (UIS) Test Circuit & Waveforms



Diode Recovery Test Circuit & Waveforms

