

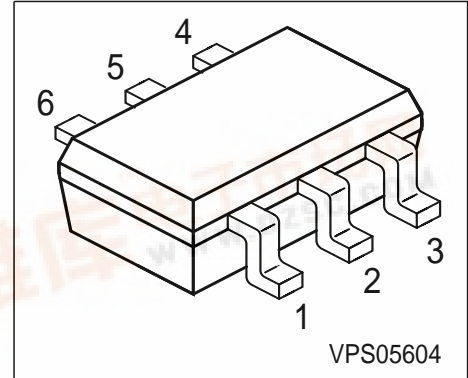

BCR19PN

NPN/PNP Silicon Digital Transistor Array

- Switching circuit, inverter, interface circuit, driver circuit
- Two (galvanic) internal isolated NPN/PNP Transistors in one package
- Built in bias resistor ($R_1=4.7k\Omega$)



Tape loading orientation

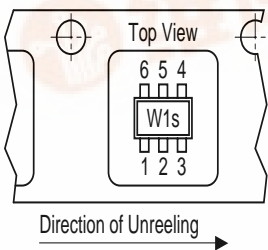

Marking on SOT-363 package (for example W1s) corresponds to pin 1 of device

Position in tape: pin 1 opposite of feed hole side

EHA07193

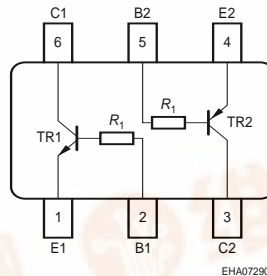

EHA07290

Type	Marking	Pin Configuration					Package	
BCR19PN	W2s	1=E1	2=B1	3=C2	4=E2	5=B2	6=C1	SOT363

Maximum Ratings

Parameter	Symbol	Value	Unit
Collector-emitter voltage	V_{CEO}	50	V
Collector-base voltage	V_{CBO}	50	V
Emitter-base voltage	V_{EBO}	10	V
Input on Voltage	$V_{i(on)}$	15	V
DC collector current	I_C	100	mA
Total power dissipation, $T_S = 115^\circ C$	P_{tot}	250	mW
Junction temperature	T_j	150	$^\circ C$
Storage temperature	T_{stg}	-65 ... 150	$^\circ C$

Thermal Resistance

Junction - soldering point ¹⁾	R_{thJS}	≤ 140	K/W
--	------------	------------	-----

¹⁾For calculation of R_{thJA} please refer to Application Note Thermal Resistance

Electrical Characteristics at $T_A=25^\circ\text{C}$, unless otherwise specified

Parameter	Symbol	Values			Unit
		min.	typ.	max.	
DC Characteristics					
Collector-emitter breakdown voltage $I_C = 100 \mu\text{A}, I_B = 0$	$V_{(BR)CEO}$	50	-	-	V
Collector-base breakdown voltage $I_C = 10 \mu\text{A}, I_E = 0$	$V_{(BR)CBO}$	50	-	-	
Emitter-base breakdown voltage $I_E = 10 \mu\text{A}, I_C = 0$	$V_{(BR)EBO}$	10	-	-	
Collector cutoff current $V_{CB} = 40 \text{ V}, I_E = 0$	I_{CBO}	-	-	100	nA
DC current gain 1) $I_C = 5 \text{ mA}, V_{CE} = 5 \text{ V}$	h_{FE}	120	-	630	-
Collector-emitter saturation voltage1) $I_C = 10 \text{ mA}, I_B = 0.5 \text{ mA}$	V_{CEsat}	-	-	0.3	V
Input off voltage $I_C = 100 \mu\text{A}, V_{CE} = 5 \text{ V}$	$V_{i(off)}$	0.4	-	0.8	
Input on Voltage $I_C = 2 \text{ mA}, V_{CE} = 0.3 \text{ V}$	$V_{i(on)}$	0.5	-	1.1	
Input resistor	R_1	3.2	4.7	6.2	$k\Omega$

AC Characteristics

Transition frequency $I_C = 10 \text{ mA}, V_{CE} = 5 \text{ V}, f = 100 \text{ MHz}$	f_T	-	150	-	MHz
Collector-base capacitance $V_{CB} = 10 \text{ V}, f = 1 \text{ MHz}$	C_{cb}	-	3	-	pF

 1) Pulse test: $t < 300\mu\text{s}$; $D < 2\%$

NPN Type

DC Current Gain $h_{FE} = f(I_C)$

$V_{CE} = 5V$ (common emitter configuration)

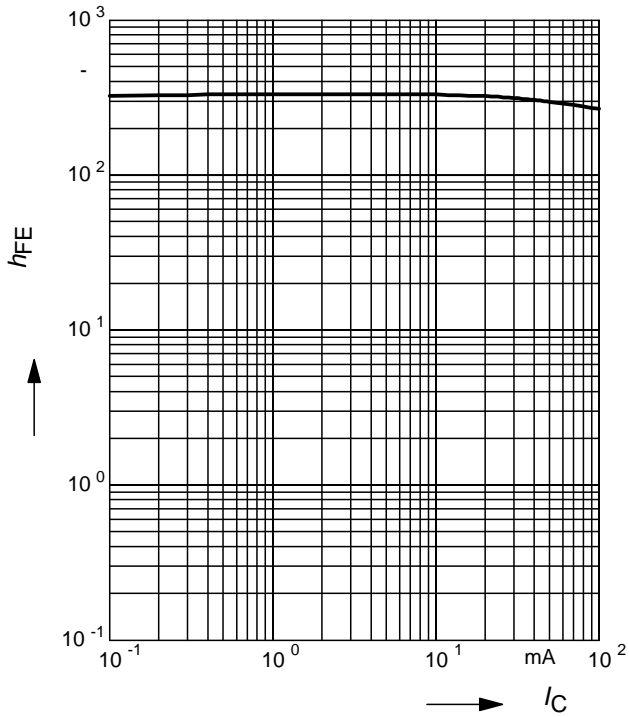

Collector-Emitter Saturation Voltage

$V_{CEsat} = f(I_C), h_{FE} = 20$

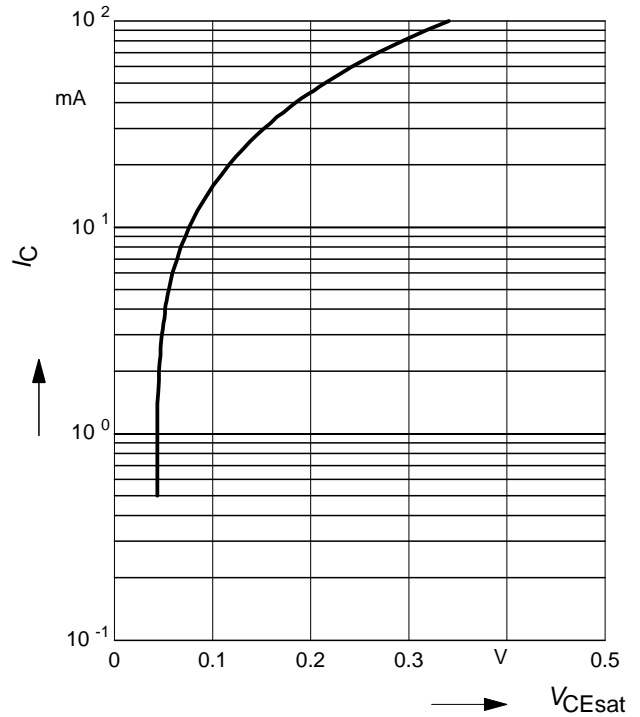

Input on Voltage $V_{i(on)} = f(I_C)$

$V_{CE} = 0.3V$ (common emitter configuration)

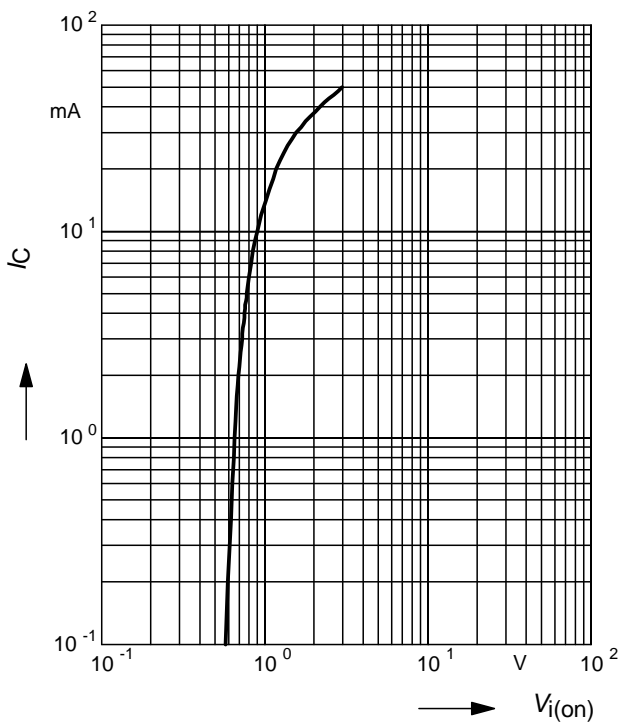

Input off voltage $V_{i(off)} = f(I_C)$

$V_{CE} = 5V$ (common emitter configuration)

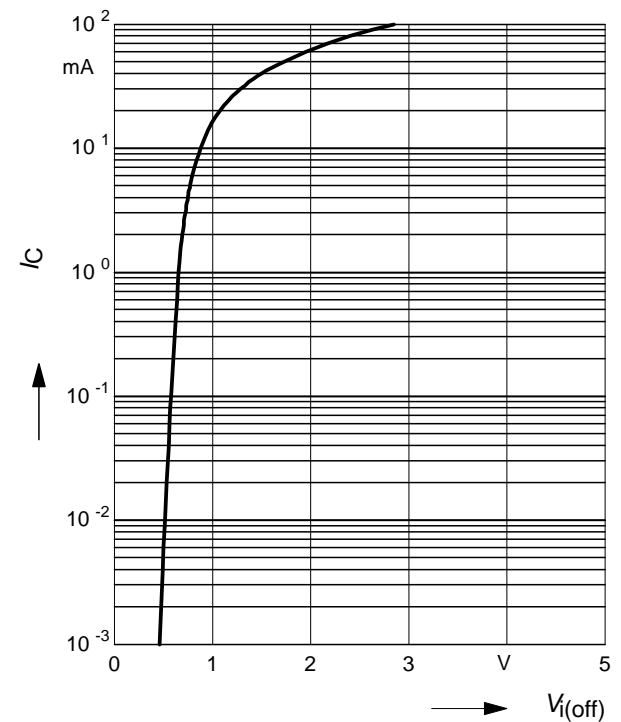

PNP Type

DC Current Gain $h_{FE} = f(I_C)$

$V_{CE} = 5V$ (common emitter configuration)

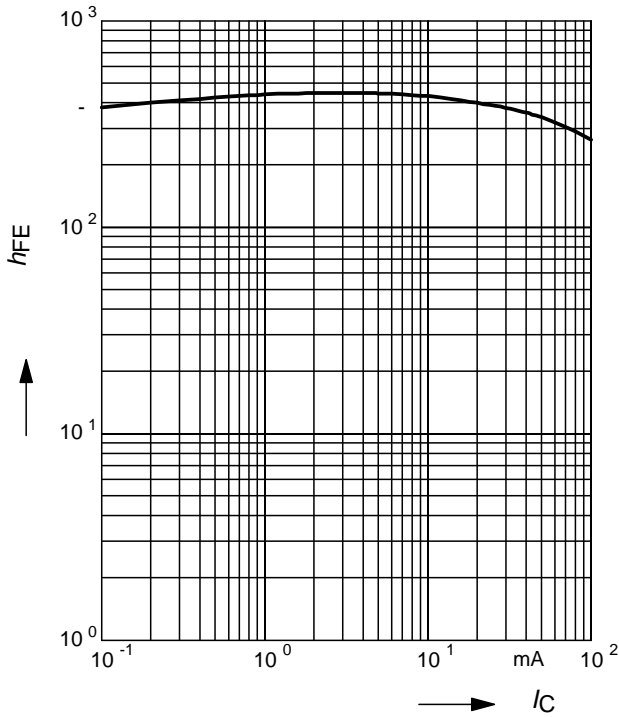

Collector-Emitter Saturation Voltage

$V_{CEsat} = f(I_C), h_{FE} = 20$

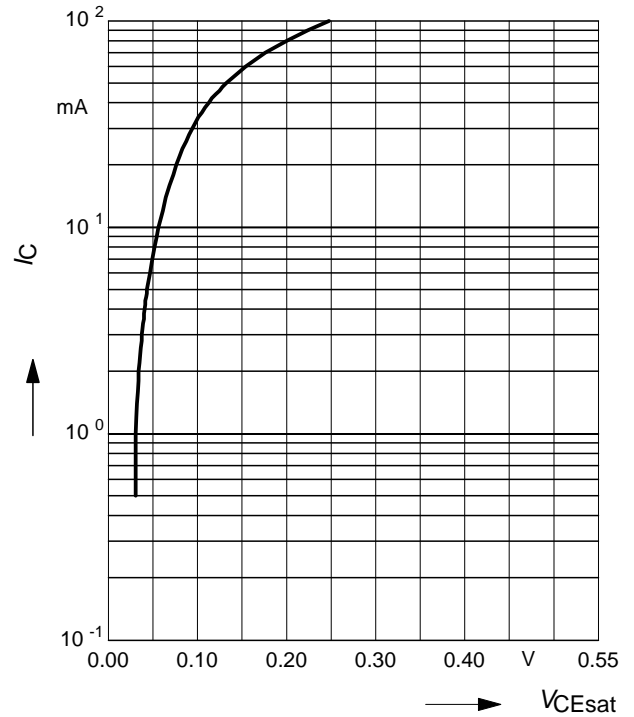

Input on Voltage $V_{i(on)} = f(I_C)$

$V_{CE} = 0.3V$ (common emitter configuration)

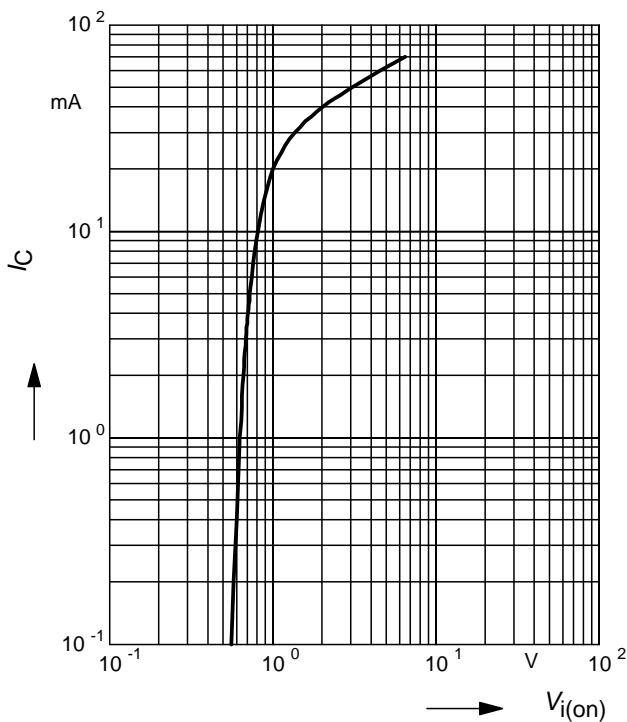

Input off voltage $V_{i(off)} = f(I_C)$

$V_{CE} = 5V$ (common emitter configuration)

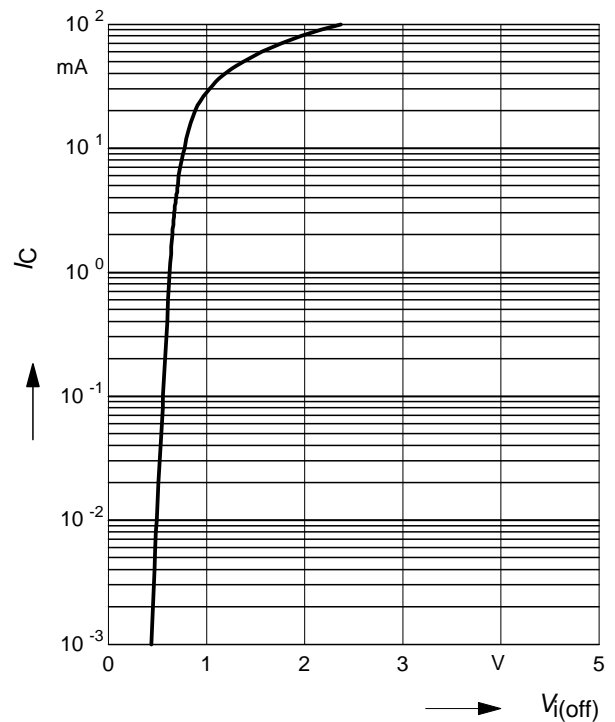

Total power dissipation $P_{tot} = f(T_S)$

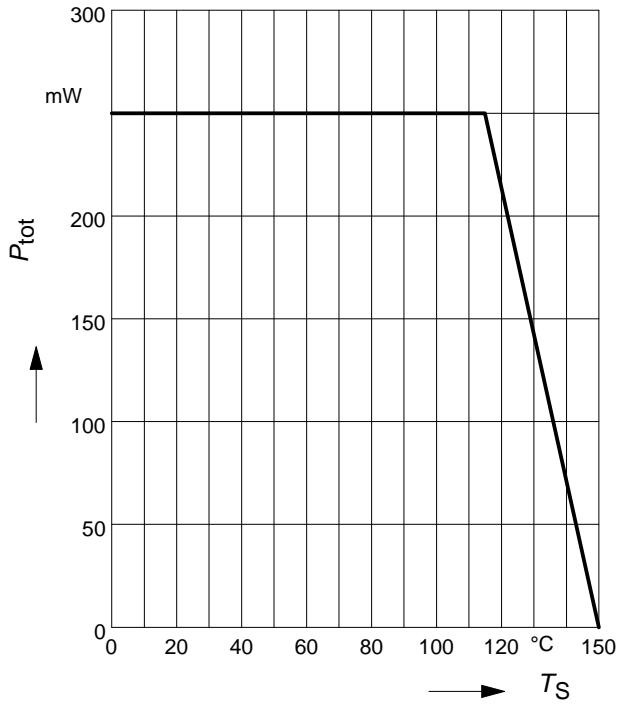

Permissible Pulse Load $R_{thJS} = f(t_p)$

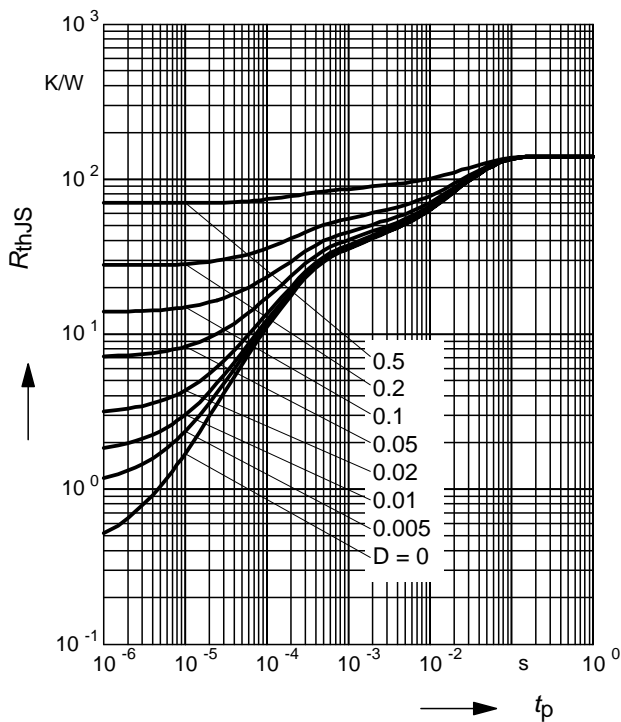

Permissible Pulse Load

$P_{totmax} / P_{totDC} = f(t_p)$

