



STPS1L60

POWER SCHOTTKY RECTIFIER

Table 1: Main Product Characteristics

$I_{F(AV)}$	1 A
V_{RRM}	60 V
$T_j(max)$	150°C
$V_F(max)$	0.56 V

FEATURES AND BENEFITS

- Negligible switching losses
- Low forward voltage drop
- Surface mount miniature package
- Avalanche capability specified

DESCRIPTION

Axial and Surface Mount Power Schottky rectifiers suited to Switched Mode Power Supplies and high frequency DC to DC converters.

Packaged in SMA and DO-41, this device is especially intended for use in low voltage, high frequency inverters and small battery chargers.

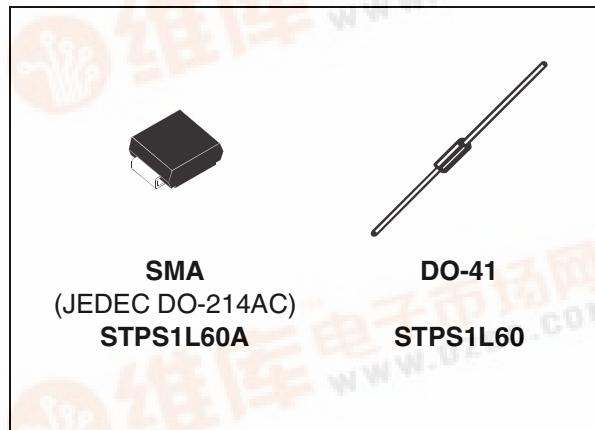

Table 2: Order Codes

Part Number	Marking
STPS1L60A	GB6
STPS1L60	STPS1L60
STPS1L60RL	STPS1L60

Table 3: Absolute Ratings (limiting values)

Symbol	Parameter	Value	Unit	
V_{RRM}	Repetitive peak reverse voltage	60	V	
$I_{F(RMS)}$	RMS forward voltage	10	A	
$I_{F(AV)}$	Average forward current	SMA $T_L = 130^\circ\text{C} \quad \delta = 0.5$	1	A
		DO-41 $T_L = 120^\circ\text{C} \quad \delta = 0.5$		
I_{FSM}	Surge non repetitive forward current	$t_p = 10\text{ms}$ sinusoidal	40	A
P_{ARM}	Repetitive peak avalanche power	$t_p = 1\mu\text{s} \quad T_j = 25^\circ\text{C}$	1200	W
T_{stg}	Storage temperature range	-65 to + 150	°C	
T_j	Maximum operating junction temperature *	150	°C	
dV/dt	Critical rate of rise of reverse voltage	10000	V/ μs	

*: $\frac{dP_{tot}}{dT_j} > \frac{1}{R_{th(j-a)}}$ thermal runaway condition for a diode on its own heatsink



STPS1L60

Table 4: Thermal Resistance

Symbol	Parameter		Value	Unit
$R_{th(j-a)}$	Junction to ambient	SMA	120	°C/W
		Lead length = 10 mm DO-41	100	
$R_{th(j-l)}$	Junction to lead	SMA	30	°C/W
		Lead length = 10 mm DO-41	45	

Table 5: Static Electrical Characteristics

Symbol	Parameter	Tests conditions		Min.	Typ	Max.	Unit
I_R^*	Reverse leakage current	$T_j = 25^\circ\text{C}$	$V_R = V_{RRM}$			50	μA
		$T_j = 100^\circ\text{C}$			1.5	5	mA
V_F^{**}	Forward voltage drop	$T_j = 25^\circ\text{C}$	$I_F = 1\text{A}$			0.57	V
		$T_j = 100^\circ\text{C}$				0.56	
		$T_j = 125^\circ\text{C}$			0.5	0.54	
		$T_j = 25^\circ\text{C}$	$I_F = 2\text{A}$			0.75	
		$T_j = 100^\circ\text{C}$				0.68	
		$T_j = 125^\circ\text{C}$			0.6	0.66	

Pulse test: * $t_p = 380 \mu\text{s}$, $\delta < 2\%$

To evaluate the conduction losses use the following equation: $P = 0.44 \times I_{F(AV)} + 0.12 I_F^2 (RMS)$

Figure 1: Average forward power dissipation versus average forward current

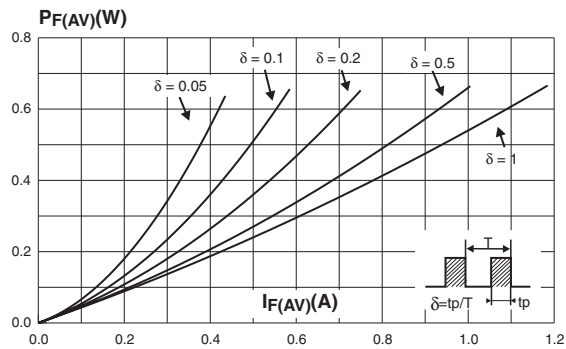

Figure 2: Average forward current versus ambient temperature (delta = 0.5)

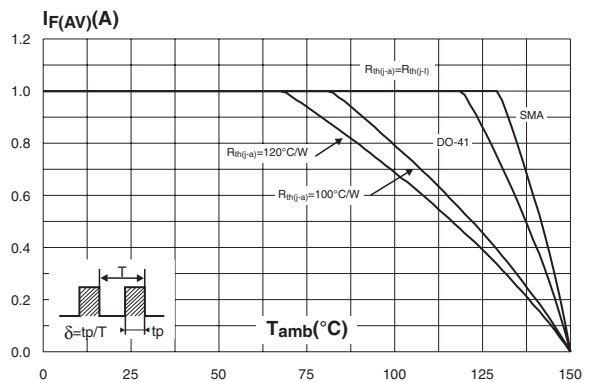

Figure 3: Normalized avalanche power derating versus pulse duration

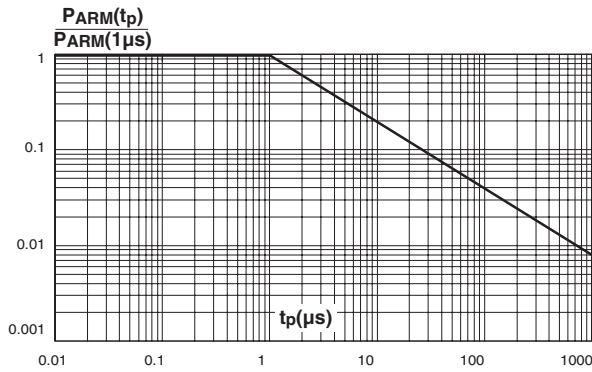

Figure 4: Normalized avalanche power derating versus junction temperature

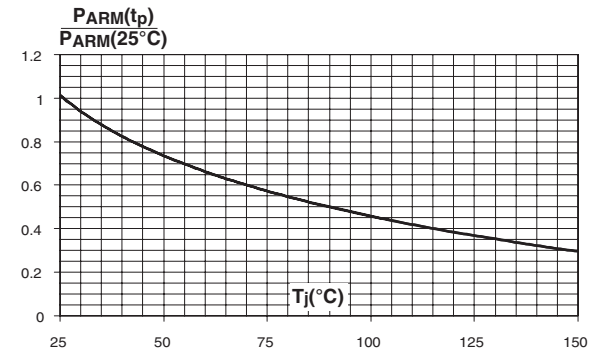

Figure 5: Non repetitive surge peak forward current versus overload duration (maximum values) (SMA)

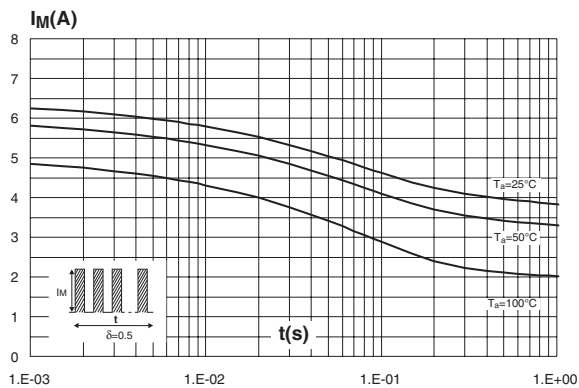

Figure 6: Non repetitive surge peak forward current versus overload duration (maximum values) (DO-41)

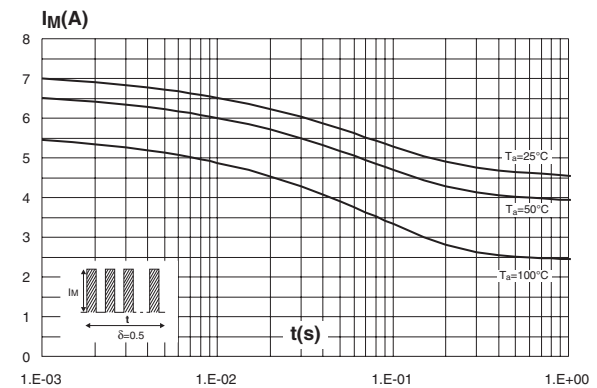

Figure 7: Relative variation of thermal impedance junction to ambient versus pulse duration (epoxy printed circuit board, e(Cu)=35µm, recommended pad layout) (SMA)

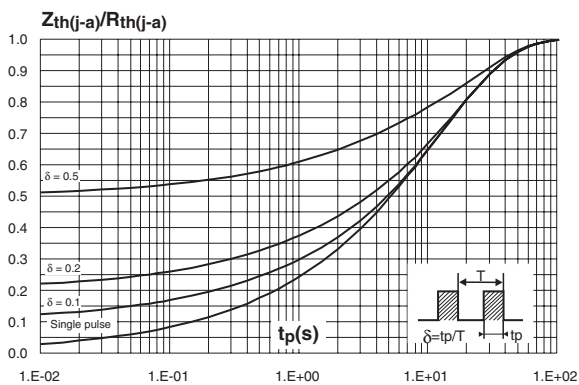
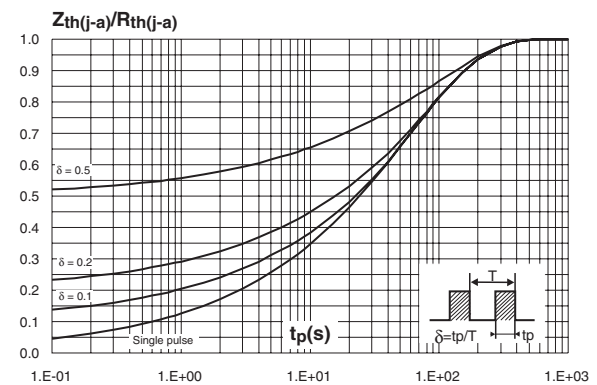

Figure 8: Relative variation of thermal impedance junction to ambient versus pulse duration (DO-41)



STPS1L60

Figure 9: Reverse leakage current versus reverse voltage applied (typical values)

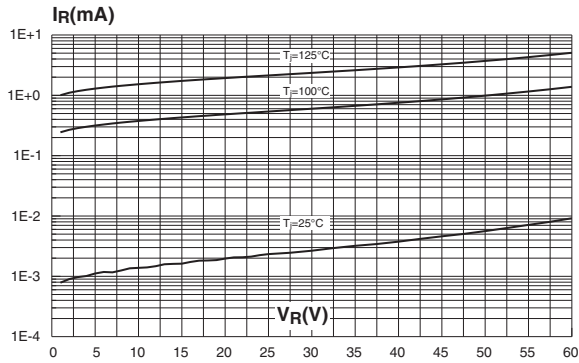

Figure 10: Junction capacitance versus reverse voltage applied (typical values)

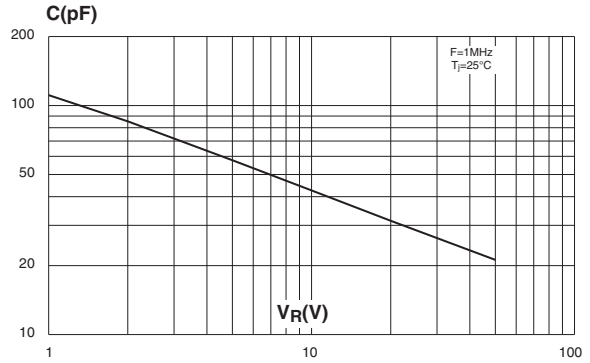

Figure 11: Forward voltage drop versus forward current (maximum values, high level) (SMA)

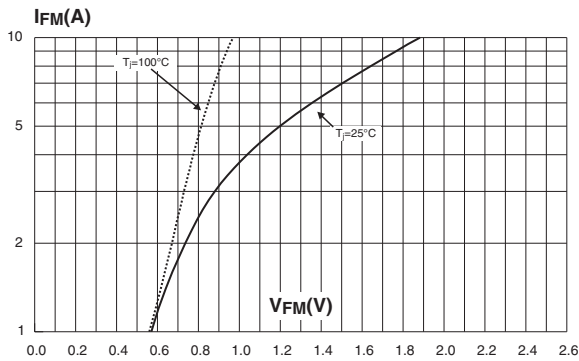

Figure 12: Forward voltage drop versus forward current (maximum values, low level) (DO-41)

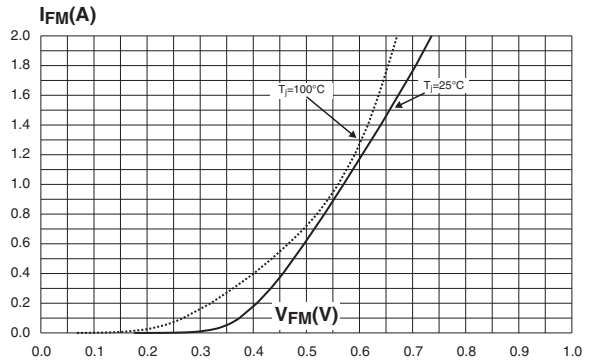

Figure 13: Thermal resistance junction to ambient versus copper surface under each lead (Epoxy printed circuit board FR4, copper thickness: 35µm) (SMA)

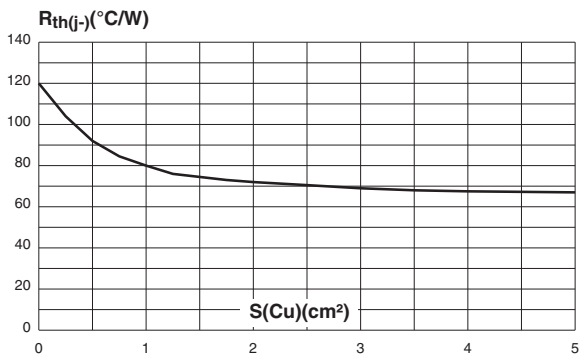

Figure 14: Thermal resistance versus lead length (DO-41)

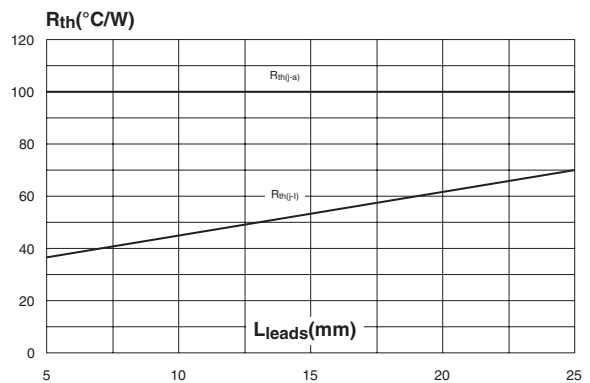
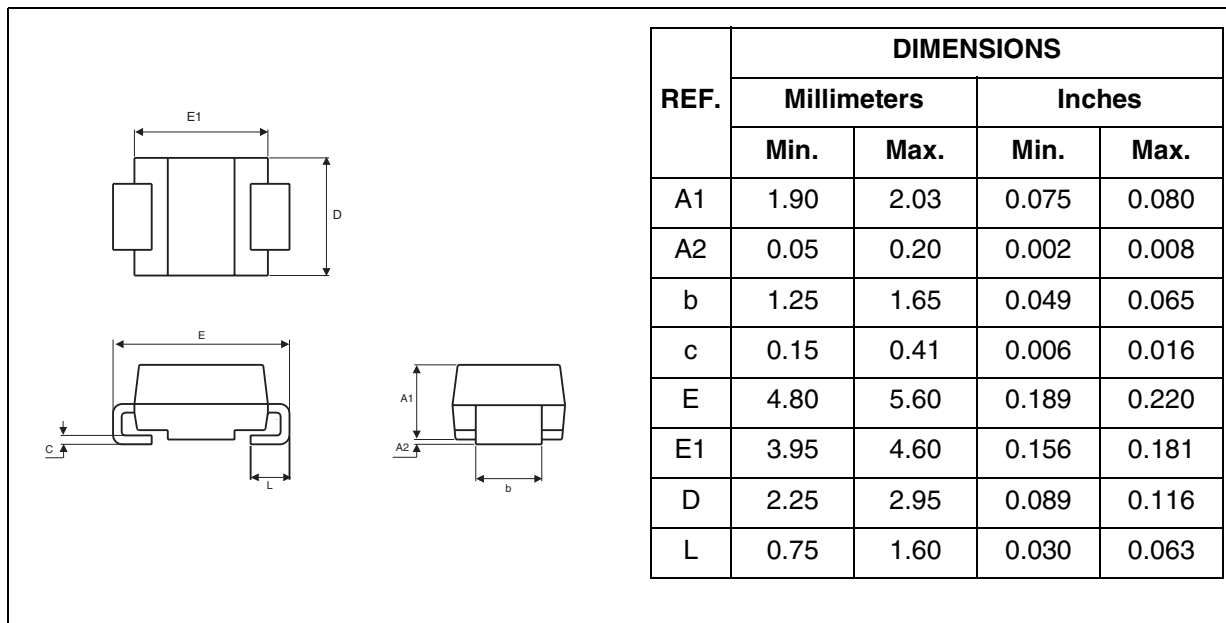
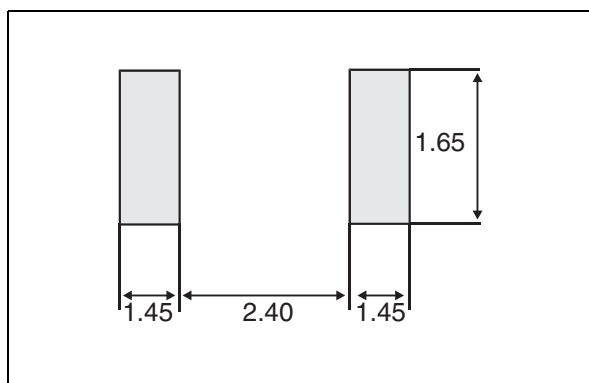

Figure 15: SMA Package Mechanical Data

Figure 16: SMA Foot Print Dimensions
(in millimeters)

STPS1L60

Figure 17: DO-41 Package Mechanical Data

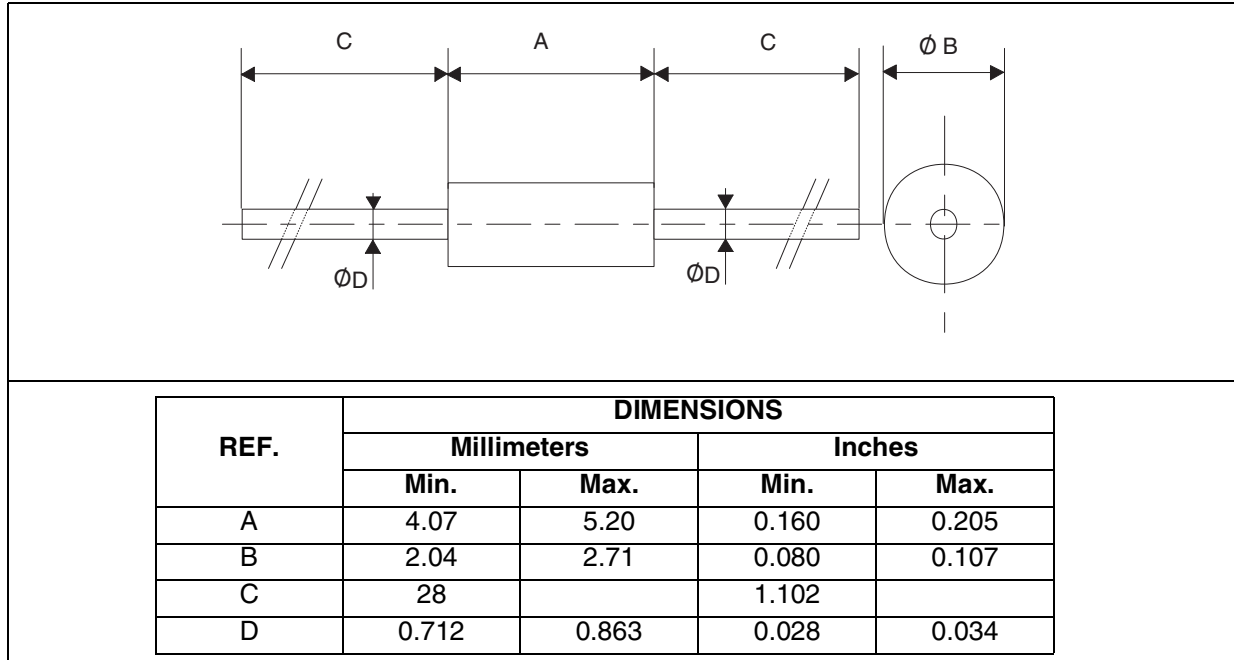

Table 6: Ordering Information

Ordering type	Marking	Package	Weight	Base qty	Delivery mode
STPS1L60A	GB6	SMA	0.068 g	5000	Tape & reel
STPS1L60	STPS1L60	DO-41	0.34 g	2000	Ammopack
STPS1L60RL	STPS1L60	DO-41	0.34 g	5000	Tape & reel

- Band indicates cathode
- Epoxy meets UL94, V0

Table 7: Revision History

Date	Revision	Description of Changes
Jul-2003	5A	Last update.
Aug-2004	6	SMA package dimensions update. Reference A1 max. changed from 2.70mm (0.106inc.) to 2.03mm (0.080).

Information furnished is believed to be accurate and reliable. However, STMicroelectronics assumes no responsibility for the consequences of use of such information nor for any infringement of patents or other rights of third parties which may result from its use. No license is granted by implication or otherwise under any patent or patent rights of STMicroelectronics. Specifications mentioned in this publication are subject to change without notice. This publication supersedes and replaces all information previously supplied. STMicroelectronics products are not authorized for use as critical components in life support devices or systems without express written approval of STMicroelectronics.

The ST logo is a registered trademark of STMicroelectronics.
All other names are the property of their respective owners

© 2004 STMicroelectronics - All rights reserved

STMicroelectronics group of companies

Australia - Belgium - Brazil - Canada - China - Czech Republic - Finland - France - Germany - Hong Kong - India - Israel - Italy - Japan - Malaysia - Malta - Morocco - Singapore - Spain - Sweden - Switzerland - United Kingdom - United States of America

www.st.com