

SPECIFICATION

DEVICE NAME : IGBT

TYPE NAME : 1MBH10D-060

SPEC. No. :

DATE :

Fuji Electric Co.,Ltd.

This Specification is subject to change without notice.

	DATE	NAME	APPROVED	Fuji Electric Co.,Ltd.		
DRAWN				DWG.NO.	1/12	
CHECKED						



Ratings and characteristics of Fuji IGBT

1MBH10D-060

1. Outline Drawing

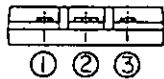
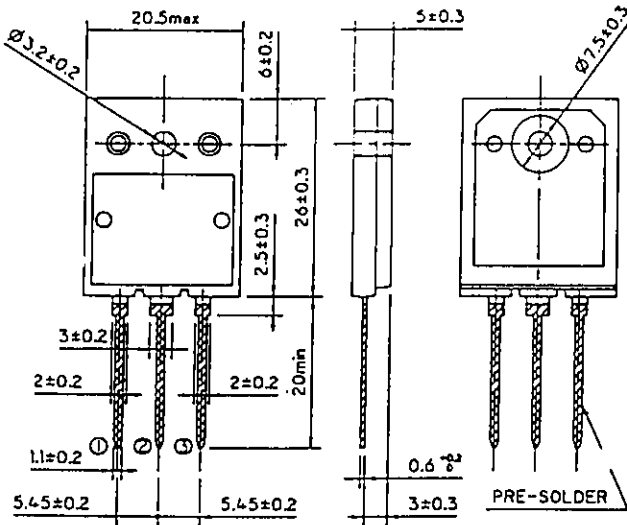

CONNECTION

- ① GATE
- ② COLLECTOR
- ③ EMITTER

2. Equivalent circuit

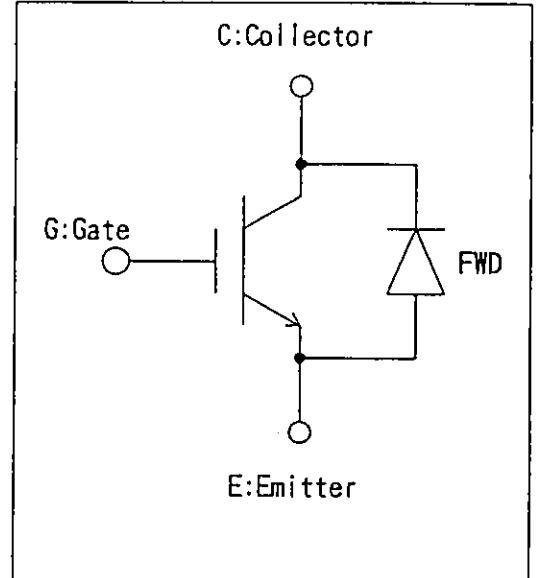

3. Absolute maximum ratings (Tc=25°C)

Items		Symbols	Ratings	Units	
Collector-Emitter Voltage		V_{CES}	600	V	
Gate-Emitter Voltage		V_{GES}	±20	V	
Collector Current	DC	Tc=25 °C	I_{C25}	30	A
		Tc=115°C	I_{C115}	10	A
	1ms	Tc=25 °C	I_{cp}	80	A
IGBT Max. Power Dissipation		P_c	115	W	
FWD Max. Power Dissipation		P_c	55	W	
Operating Temperature		T_j	+ 150	°C	
Storage Temperature		T_{stg}	-40 ~ +150	°C	
Mounting Screw Torque		—	70	N · cm	

4. Electrical Characteristics (at Tc=25°C unless otherwise specified)

Items	Symbols	Characteristics			Conditions	Unit	
		min.	typ.	max.			
Zero gate voltage Collector Current	I_{CES}			1.0	$V_{GE} = 0V$ $V_{CE} = 600V$	mA	
Gate-Emitter leakage Current	I_{GES}			20	$V_{CE} = 0V$ $V_{GE} = \pm 20V$	μA	
Gate-Emitter Threshold Voltage	$V_{GE(th)}$	5.5		8.5	$V_{CE} = 20V$ $I_C = 10mA$	V	
Collector-Emitter Saturation Voltage	$V_{CE(sat)}$			3.0	$V_{GE} = 15V$ $I_C = 10A$	V	
Input capacitance	C_{ies}		700		$V_{GE} = 0V$	pF	
Output capacitance	C_{oes}		150		$V_{CE} = 10V$		
Reverse transfer capacitance	C_{res}		20		$f = 1MHz$		
Switching Time	Turn-on time	t_{on}		1.2	$V_{CC} = 300V$ $I_C = 10A$ $V_{GE} = \pm 15V$ $R_G = 220\Omega$ (Half Bridge)	μs	
		t_r		0.6			
	Turn-off time	t_{off}		1.0			
		t_f		0.35			
	Turn-on time	t_{on}		0.16			$V_{CC} = 300V$ $I_C = 10A$ $V_{GE} = +15V$ $R_G = 22\Omega$ (Half Bridge)
		t_r		0.11			
Turn-off time	t_{off}		0.30				
	t_f		0.35				
FWD forward voltage drop	V_F			3.0	$I_F = 10A$	V	
Reverse recovery time	t_{rr}			0.3	$I_F = 10A, V_{GE} = -10V$ $V_R = 200V$ $di/dt = 100A/\mu s$	μs	

5. Thermal resistance characteristics

Items	Symbols	Characteristics			Conditions	Unit
		min.	typ.	max.		
Thermal resistance	$R_{th(j-c)}$			1.08	IGBT	$^{\circ}C/W$
	$R_{th(j-c)}$			2.27	FWD	

This material and the information herein is the property of Fuji Electric Co., Ltd. They shall be neither reproduced, copied, lent, or disclosed in any way whatsoever for the use of any third party nor used for the manufacturing purposes without the express written consent of Fuji Electric Co., Ltd.

Collector Current vs. Collector-Emitter Voltage
 $T_j=25^\circ\text{C}$

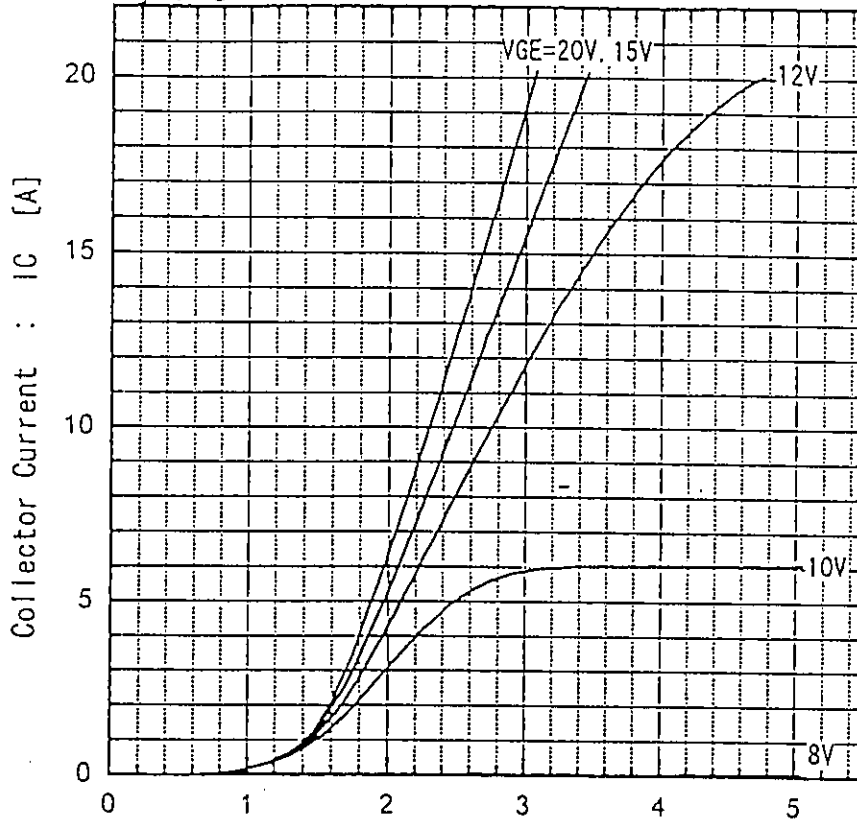

Collector-Emitter Voltage : VCE [V]
Collector Current vs. Collector-Emitter Voltage
 $T_j=125^\circ\text{C}$

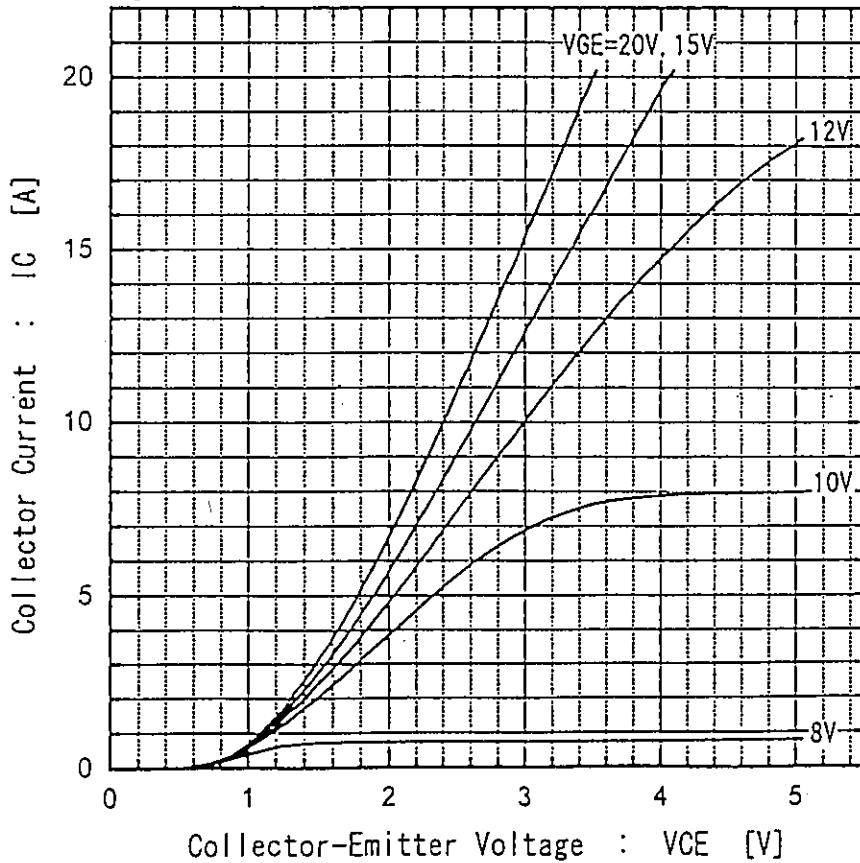

This material and the information herein is the property of Fuji Electric Co., Ltd. They shall be neither reproduced, copied, lent, or disclosed in any way whatsoever for the use of any third party nor used for the manufacturing purposes without the express written consent of Fuji Electric Co., Ltd.

Collector-Emitter Voltage vs Gate-Emitter Voltage
 $T_j=25^\circ\text{C}$

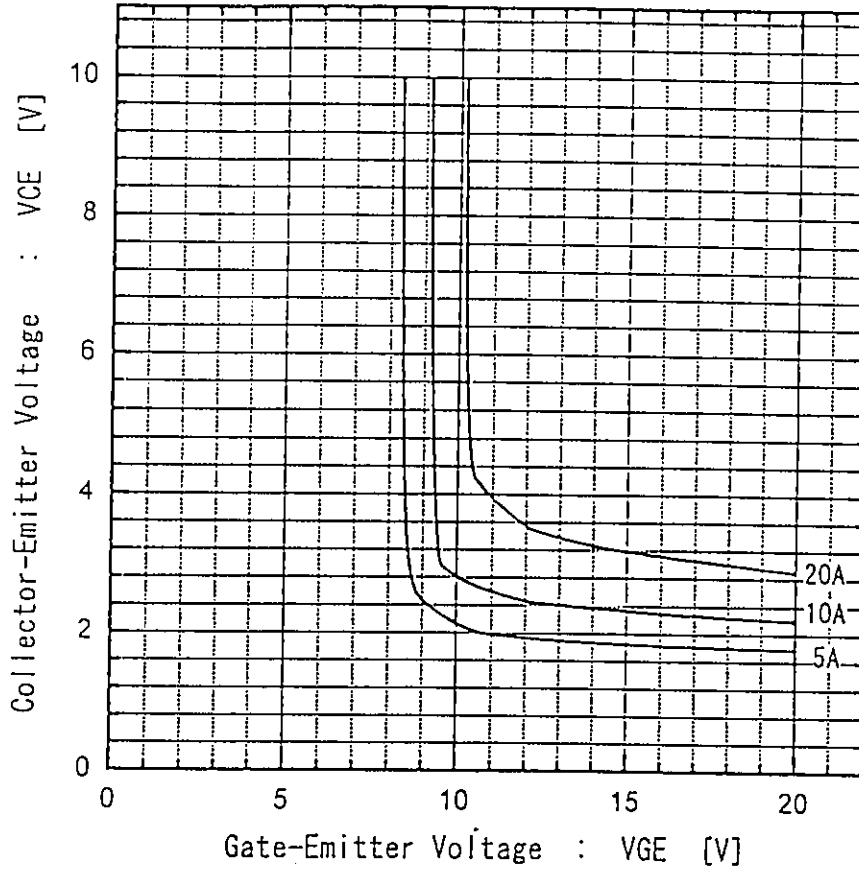

Collector-Emitter Voltage vs Gate-Emitter Voltage
 $T_j=125^\circ\text{C}$

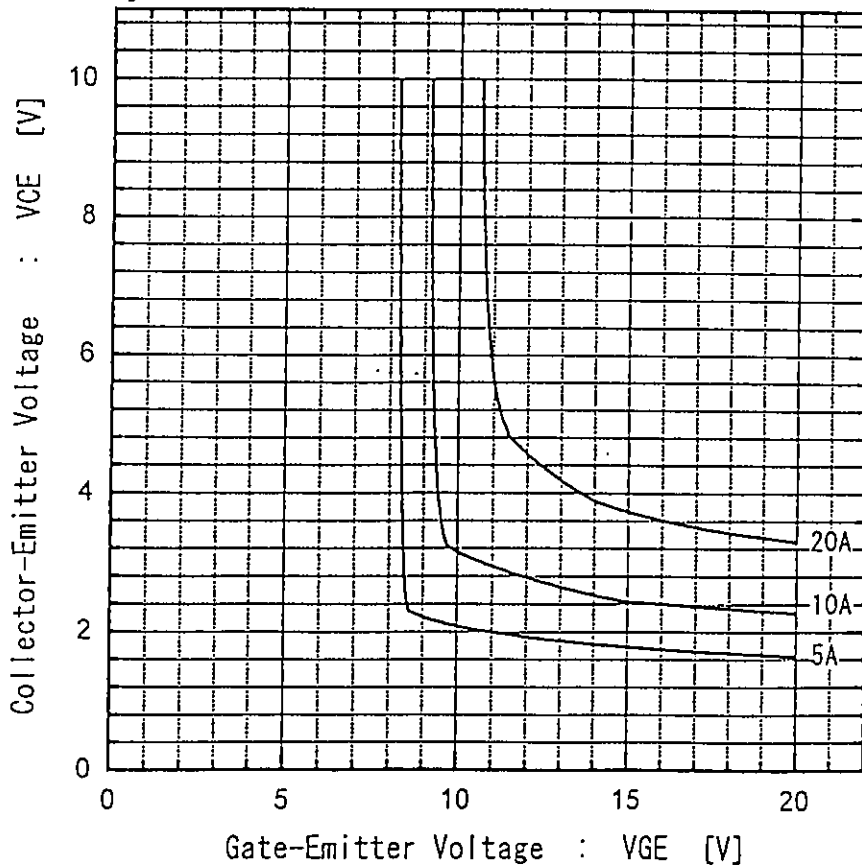

This material and the information herein is the property of Fuji Electric Co., Ltd. They shall be neither reproduced, copied, lent, or disclosed in any way whatsoever for the use of any third party nor used for the manufacturing purposes without the express written consent of Fuji Electric Co., Ltd.

Switching time vs. Collector current
 $V_{CC}=300V, R_G=22\Omega, V_{GE}=\pm 15V, T_j=25^\circ C$

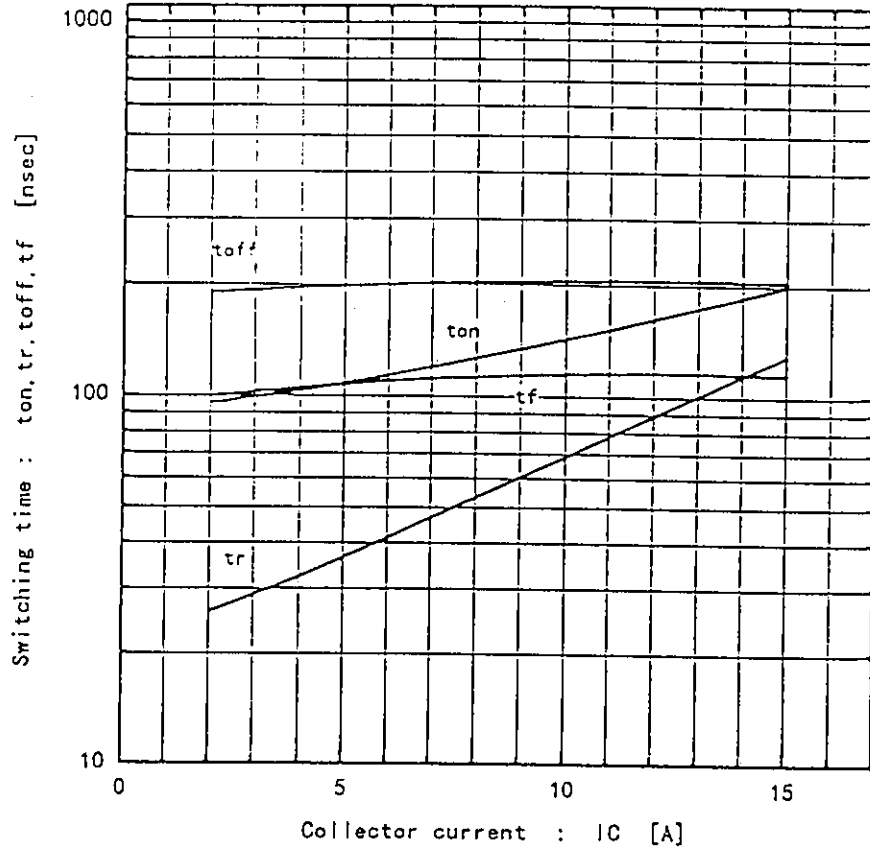

Switching time vs. Collector current
 $V_{CC}=300V, R_G=22\Omega, V_{GE}=\pm 15V, T_j=125^\circ C$

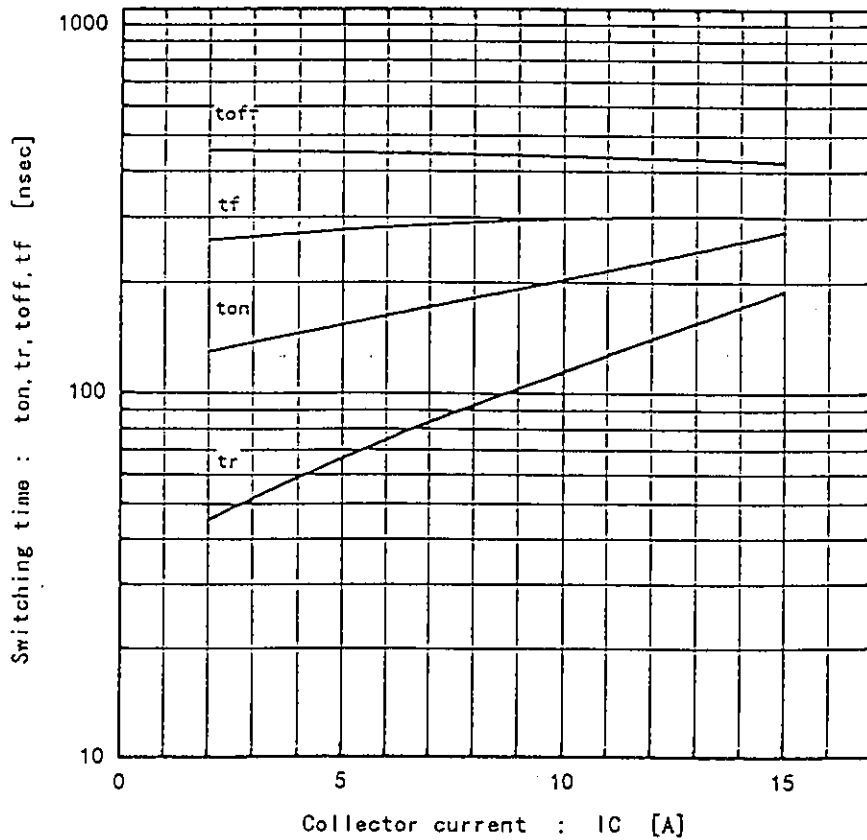

This material and the information herein is the property of Fuji Electric Co., Ltd. They shall be neither reproduced, copied, lent, or disclosed in any way whatsoever for the use of any third party nor used for the manufacturing purposes without the express written consent of Fuji Electric Co., Ltd.

Switching time vs. RG
 $V_{cc}=300V, I_C=10A, V_{GE}=\pm 15V, T_j=25^\circ C$

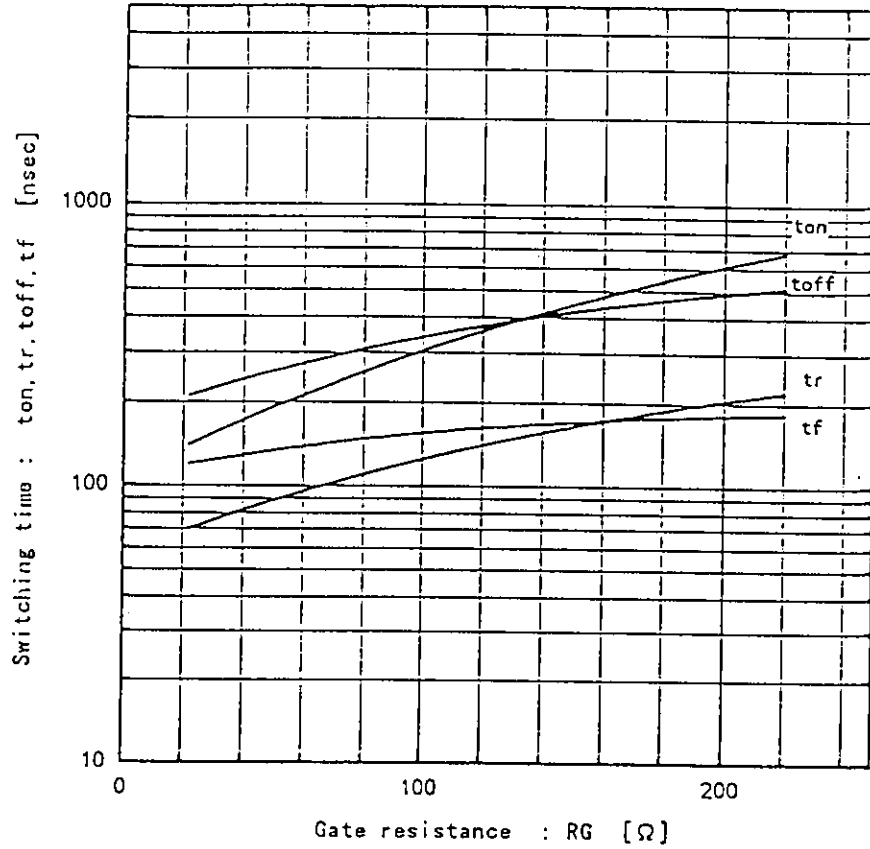

Switching time vs. RG
 $V_{cc}=300V, I_C=10A, V_{GE}=\pm 15V, T_j=125^\circ C$

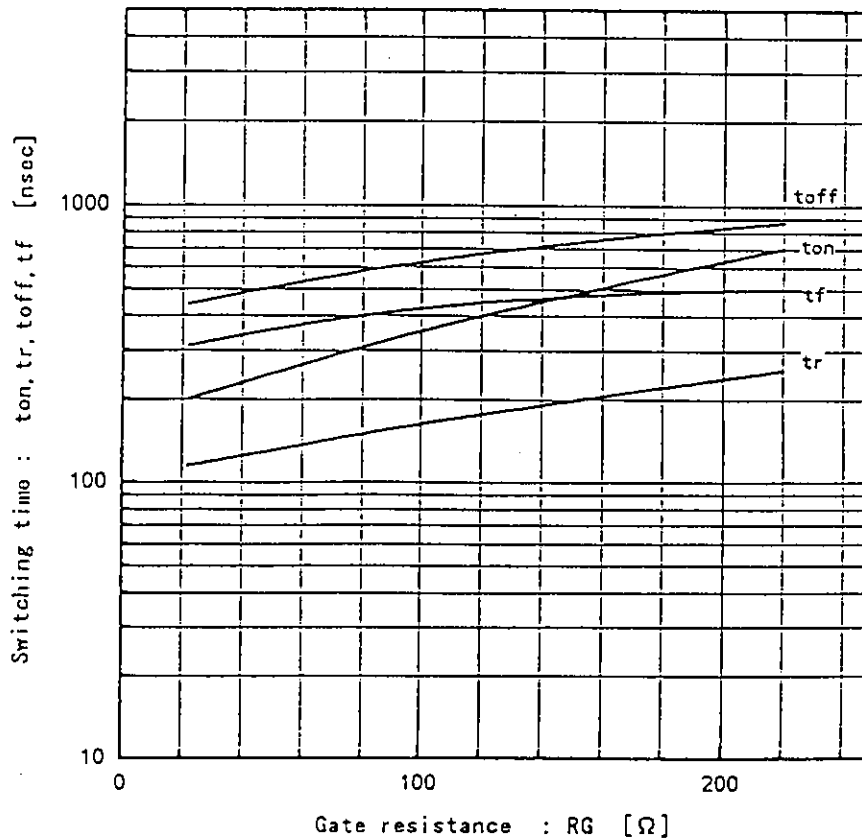

This material and the information herein is the property of Fuji Electric Co., Ltd. They shall be neither reproduced, copied, lent, or disclosed in any way whatsoever for the use of any third party nor used for the manufacturing purposes without the express written consent of Fuji Electric Co., Ltd.

Dynamic input characteristics
 $T_j=25^\circ\text{C}$

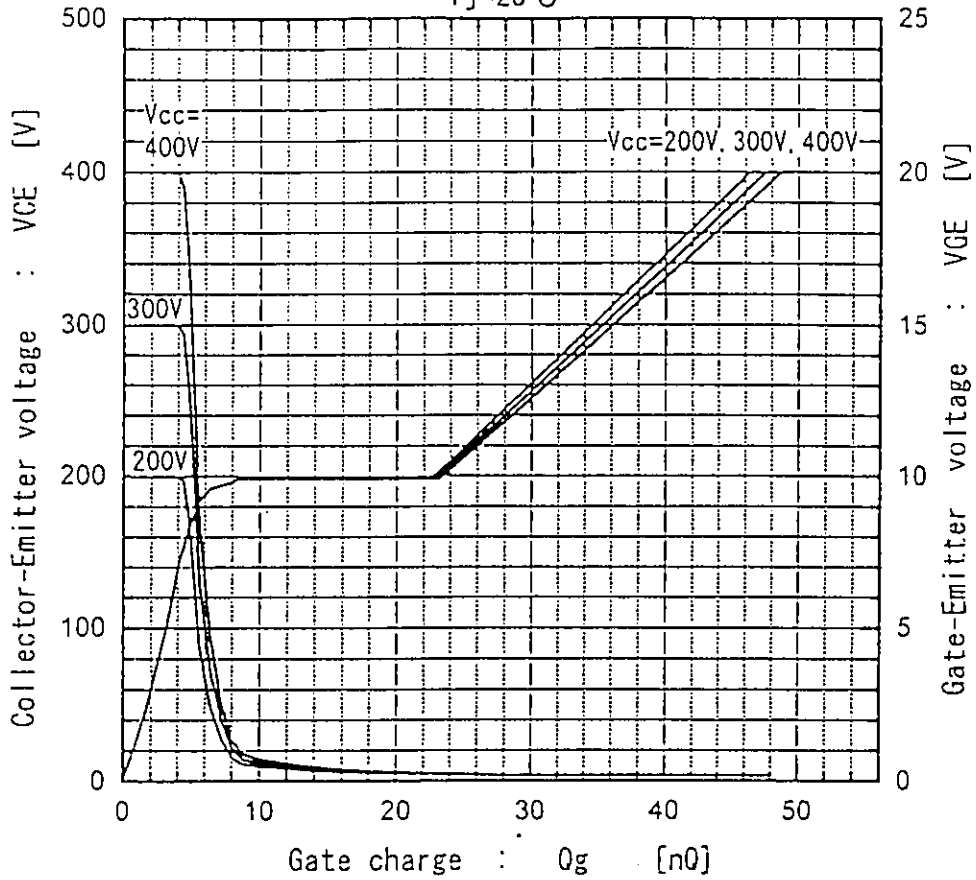

Capacitance vs. Collector-Emmitter voltage
 $T_j=25^\circ\text{C}$

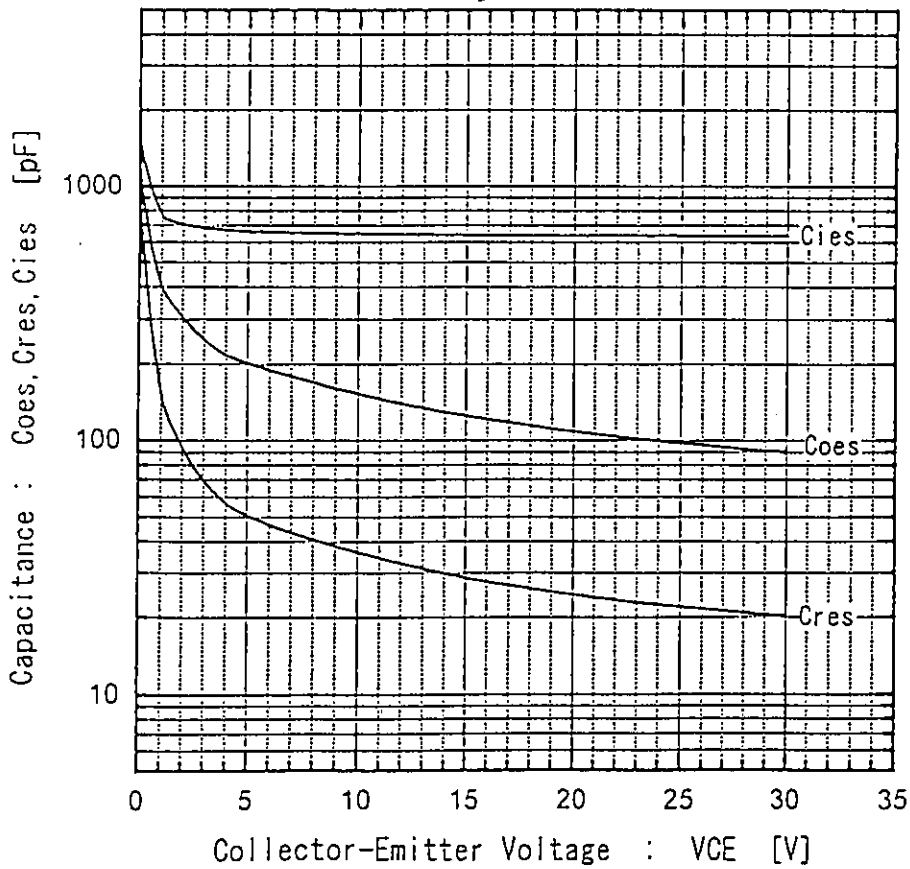

Reverse Biased Safe Operating Area
 $+V_{GE}=15V, -V_{GE} \leq 15V, T_j \leq 125^\circ C, R_G \geq 22\Omega$

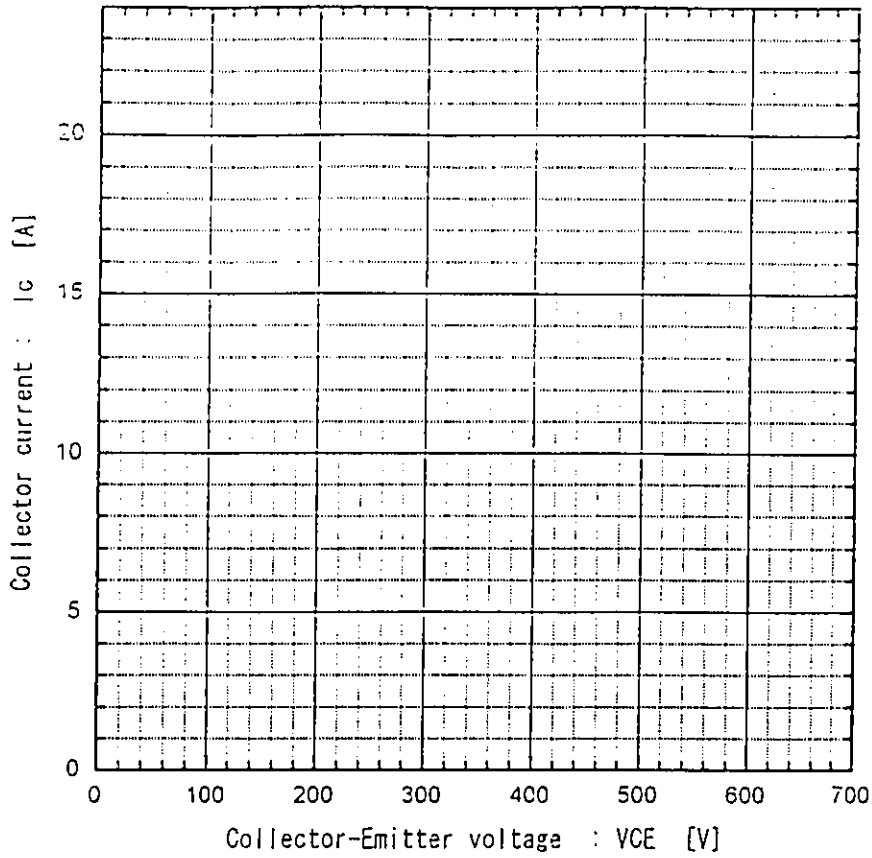

Typical short circuit capability
 $V_{CC}=400V, R_G=22\Omega, T_j=125^\circ C$

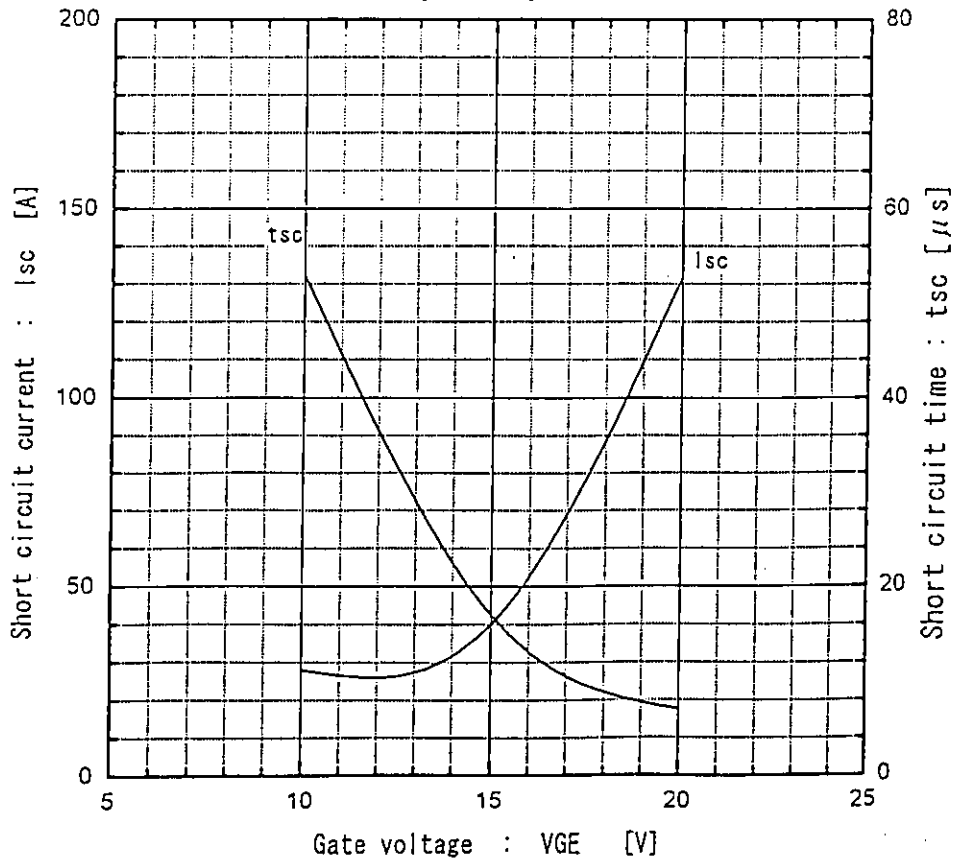

This material and the information herein is the property of Fuji Electric Co. Ltd. They shall be neither reproduced, copied, lent, or disclosed in any way whatsoever for the use of any third party nor used for the manufacturing purposes without the express written consent of Fuji Electric Co., Ltd.

Fuji Electric Co., Ltd.

DWG. NO.

9/12

H04-004-03

This material and the information herein is the property of Fuji Electric Co., Ltd. They shall be neither reproduced, copied, lent, or disclosed in any way whatsoever for the use of any third party nor used for the manufacturing purposes without the express written consent of Fuji Electric Co., Ltd.

Reverse recovery time vs. Forward current
 $V_R=200V, -di/dt=100A/\mu sec$

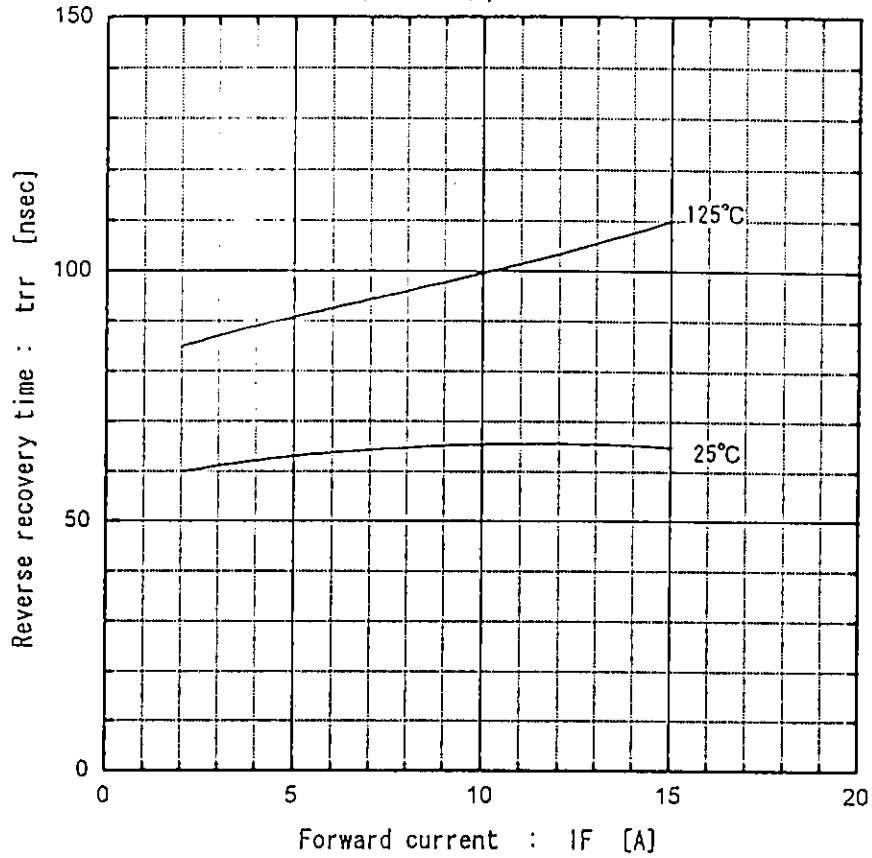

Reverse recovery current vs. Forward current
 $V_R=200V, -di/dt=100A/\mu sec$

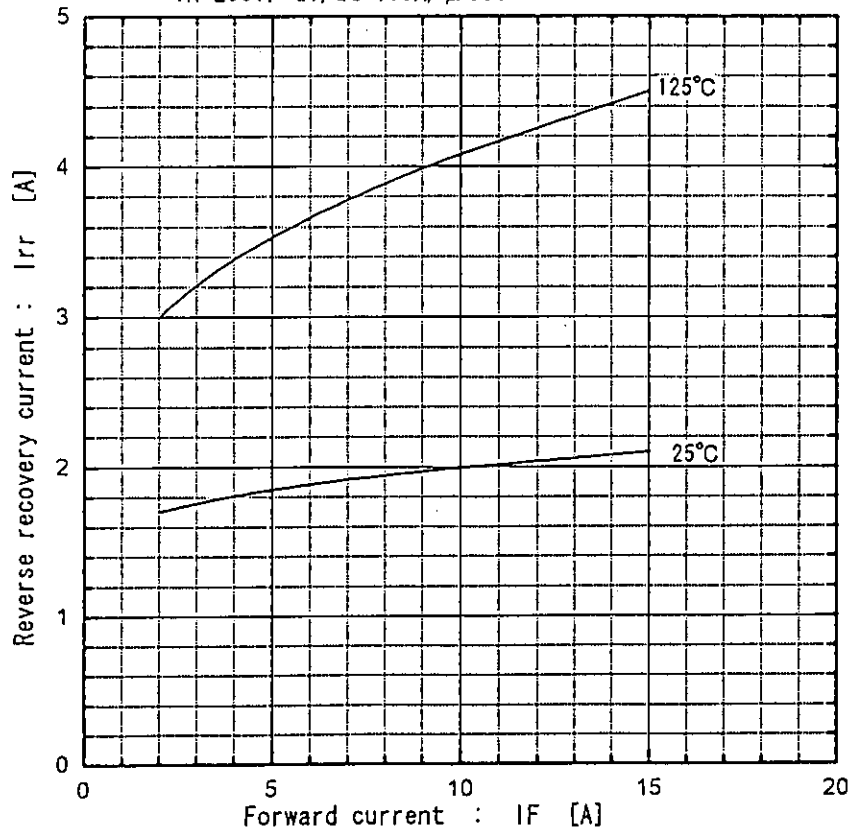

This material and the information herein is the property of Fuji Electric Co., Ltd. They shall be neither reproduced, copied, lent, or disclosed in any way whatsoever for the use of any third party nor used for the manufacturing purposes without the express written consent of Fuji Electric Co., Ltd.

Forward voltage vs. Forward current

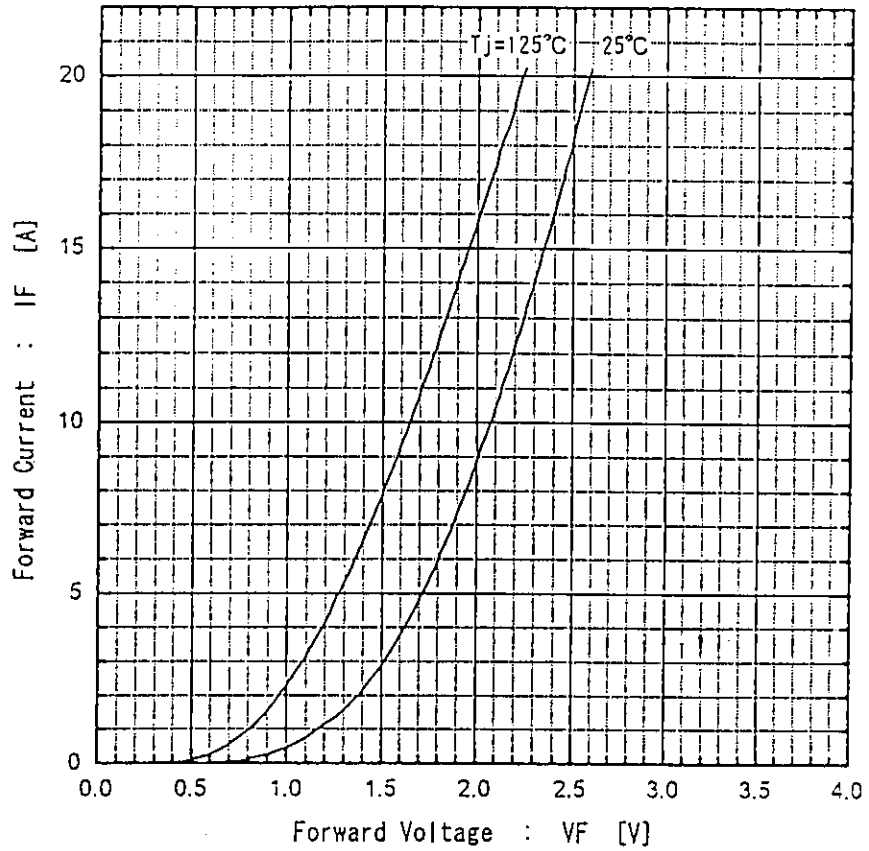

Reverse recovery characteristics vs. $-di/dt$
 $I_F=10A, T_j=125^\circ C$

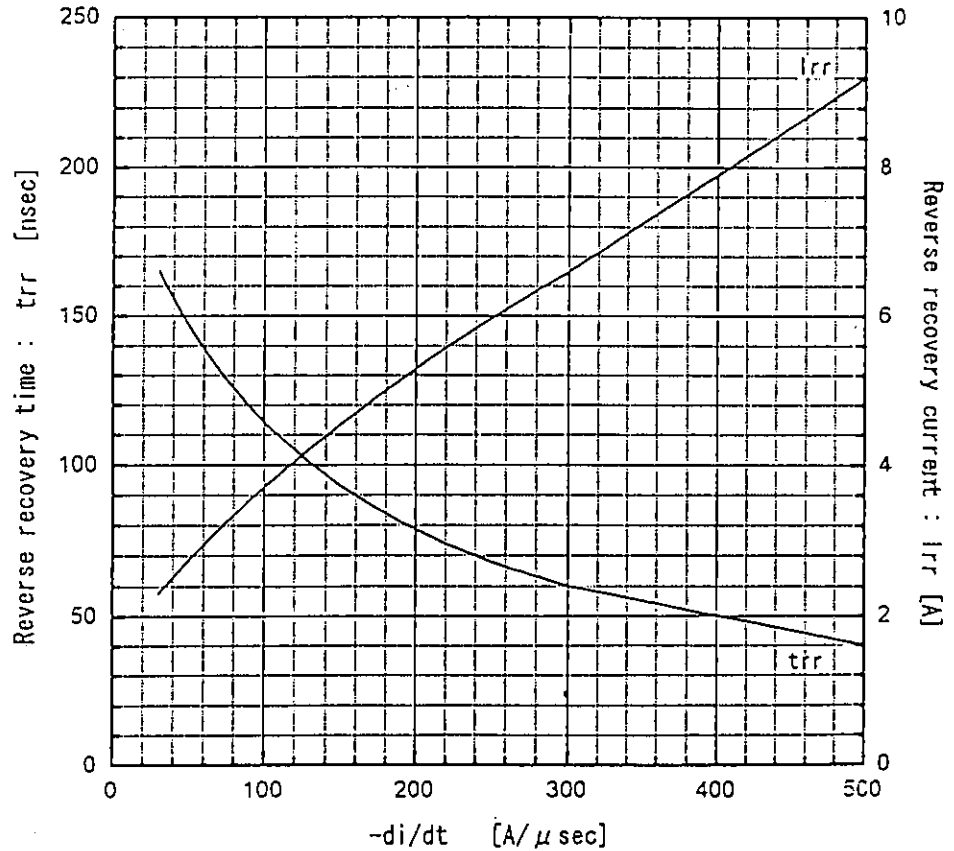

Fuji Electric Co., Ltd.

DWG. NO.

11/2

Transient thermal resistance

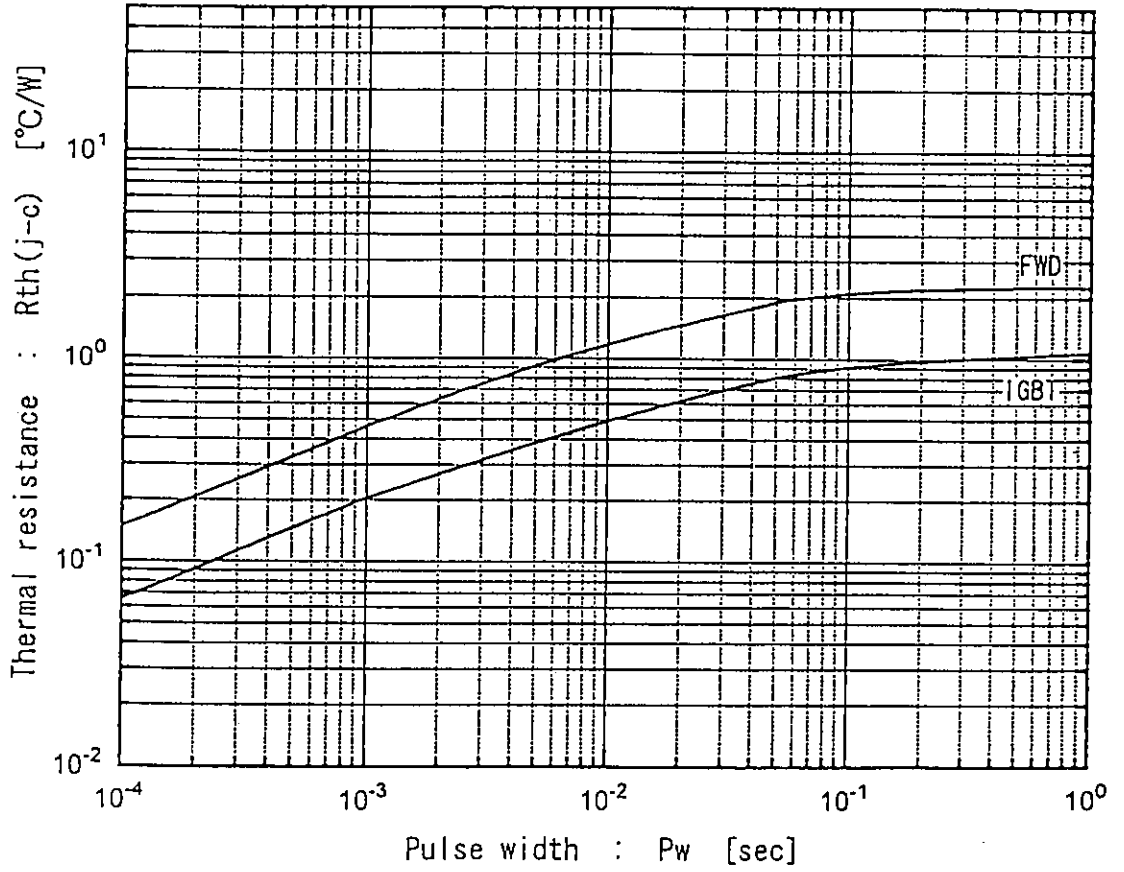

This material and the information herein is the property of Fuji Electric Co., Ltd. They shall be neither reproduced, copied, lent, or disclosed in any way whatsoever for the use of any third party nor used for the manufacturing purposes without the express written consent of Fuji Electric Co., Ltd.

For more information, contact:

Collmer Semiconductor, Inc.

P.O. Box 702708

Dallas, TX 75370

972-233-1589

972-233-0481 Fax

<http://www.collmer.com>