

SPECIFICATION

DEVICE NAME : IGBT

TYPE NAME : 1MBH15D-060

SPEC. No. :

DATE :

Fuji Electric Co.,Ltd.

This Specification is subject to change without notice.

	DATE	NAME	APPROVED	Fuji Electric Co.,Ltd.	
DRAWN				DWG NO.	1/12
CHECKED					



Ratings and characteristics of Fuji IGBT

1MBH15D-060

1. Outline Drawing

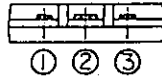
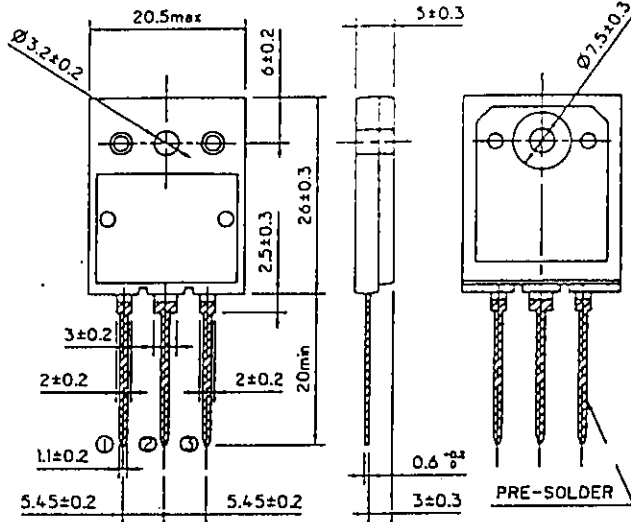

CONNECTION

- ① GATE
- ② COLLECTOR
- ③ EMITTER

2. Equivalent circuit

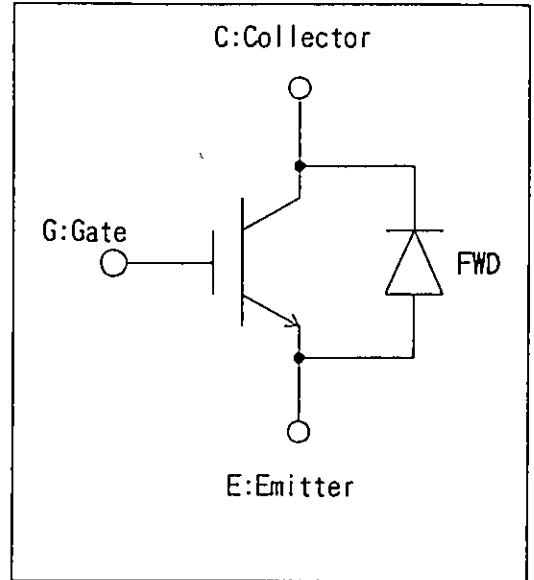

3. Absolute maximum ratings (Tc=25°C)

Items		Symbols	Ratings	Units	
Collector-Emitter Voltage		V_{CES}	600	V	
Gate-Emitter Voltage		V_{GES}	±20	V	
Collector Current	DC	Tc=25 °C	I_{C25}	37	A
		Tc=110°C	I_{C110}	15	A
	1ms	Tc=25 °C	I_{cp}	132	A
IGBT Max. Power Dissipation		P_c	140	W	
FWD Max. Power Dissipation		P_c	75	W	
Operating Temperature		T_j	+ 150	°C	
Storage Temperature		T_{stg}	-40 ~ +150	°C	
Mounting Screw Torque		—	70	N · cm	

4. Electrical Characteristics (at Tc=25°C unless otherwise specified)

Items		Symbols	Characteristics			Conditions	Unit
			min.	typ.	max.		
Zero gate voltage Collector Current		I_{CES}			1.0	$V_{GE} = 0V$ $V_{CE} = 600V$	mA
Gate-Emitter leakage Current		I_{GES}			20	$V_{CE} = 0V$ $V_{GE} = \pm 20V$	μA
Gate-Emitter Threshold Voltage		$V_{GE(th)}$	5.5		8.5	$V_{CE} = 20V$ $I_C = 15mA$	V
Collector-Emitter Saturation Voltage		$V_{CE(sat)}$			3.0	$V_{GE} = 15V$ $I_C = 15A$	V
Input capacitance		C_{ies}		1000		$V_{GE} = 0V$	pF
Output capacitance		C_{oes}		200		$V_{CE} = 10V$	
Reverse transfer capacitance		C_{res}		40		$f = 1MHz$	
Switching Time	Turn-on time	t_{on}			1.2	$V_{CC} = 300V$ $I_C = 15A$ $V_{GE} = \pm 15V$ $R_G = 160\Omega$ (Half Bridge)	μs
		t_r			0.6		
	Turn-off time	t_{off}			1.0		
		t_f			0.35		
	Turn-on time	t_{on}		0.16		$V_{CC} = 300V$ $I_C = 15A$ $V_{GE} = +15V$ $R_G = 16\Omega$ (Half Bridge)	
		t_r		0.11			
	Turn-off time	t_{off}		0.30			
		t_f			0.35		
FWD forward voltage drop		V_F			3.0	$I_F = 15A$	V
Reverse recovery time		t_{rr}			0.3	$I_F = 15A, V_{GE} = -10V$ $V_R = 200V$ $di/dt = 100A/\mu s$	μs

5. Thermal resistance characteristics

Items		Symbols	Characteristics			Conditions	Unit
			min.	typ.	max.		
Thermal resistance		$R_{th(j-c)}$			0.89	IGBT	$^{\circ}C/W$
		$R_{th(j-c)}$			1.66	FWD	

This material and the information herein is the property of Fuji Electric Co., Ltd. They shall be neither reproduced, copied, lent, or disclosed in any way whatsoever for the use of any third party nor used for the manufacturing purposes without the express written consent of Fuji Electric Co., Ltd.

Collector Current vs. Collector-Emitter Voltage
 $T_j = 25^\circ\text{C}$

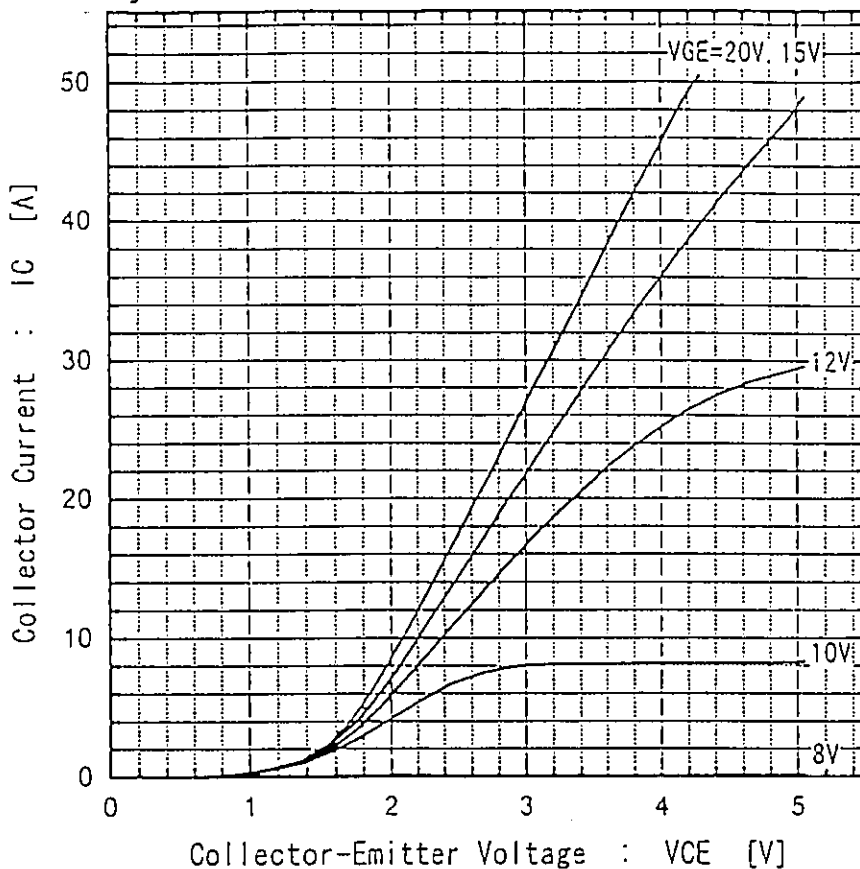

Collector Current vs. Collector-Emitter Voltage
 $T_j = 125^\circ\text{C}$

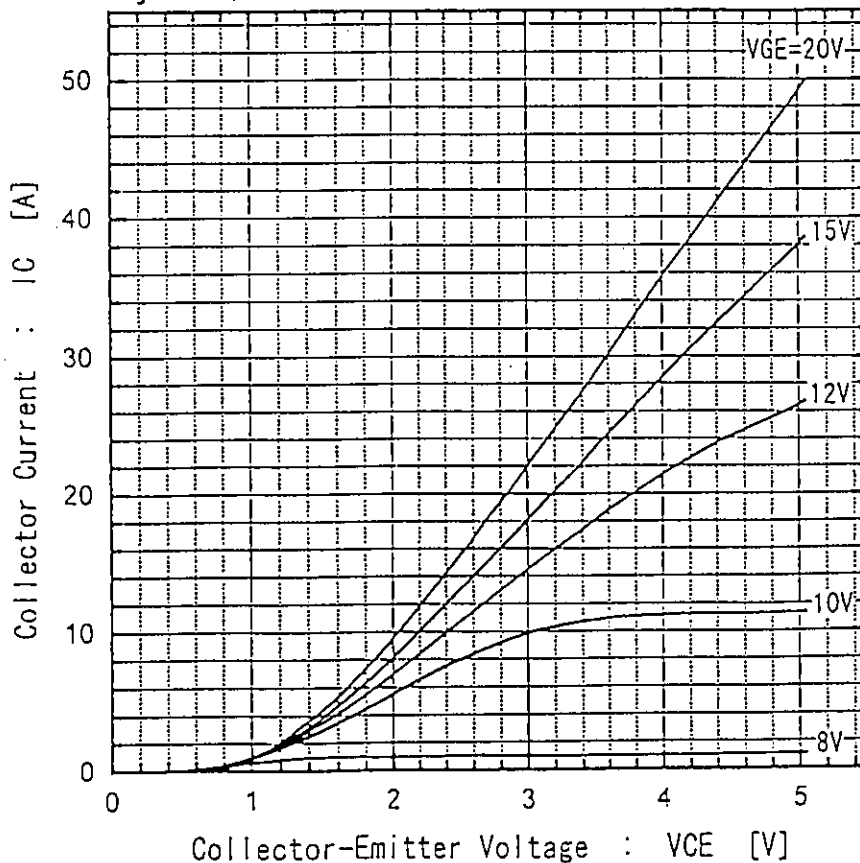

This material and the information herein is the property of Fuji Electric Co., Ltd. They shall be neither reproduced, copied, lent, or disclosed in any way whatsoever for the use of any third party nor used for the manufacturing purposes without the express written consent of Fuji Electric Co., Ltd.

Collector-Emitter Voltage vs Gate-Emitter Voltage
 $T_j=25^\circ\text{C}$

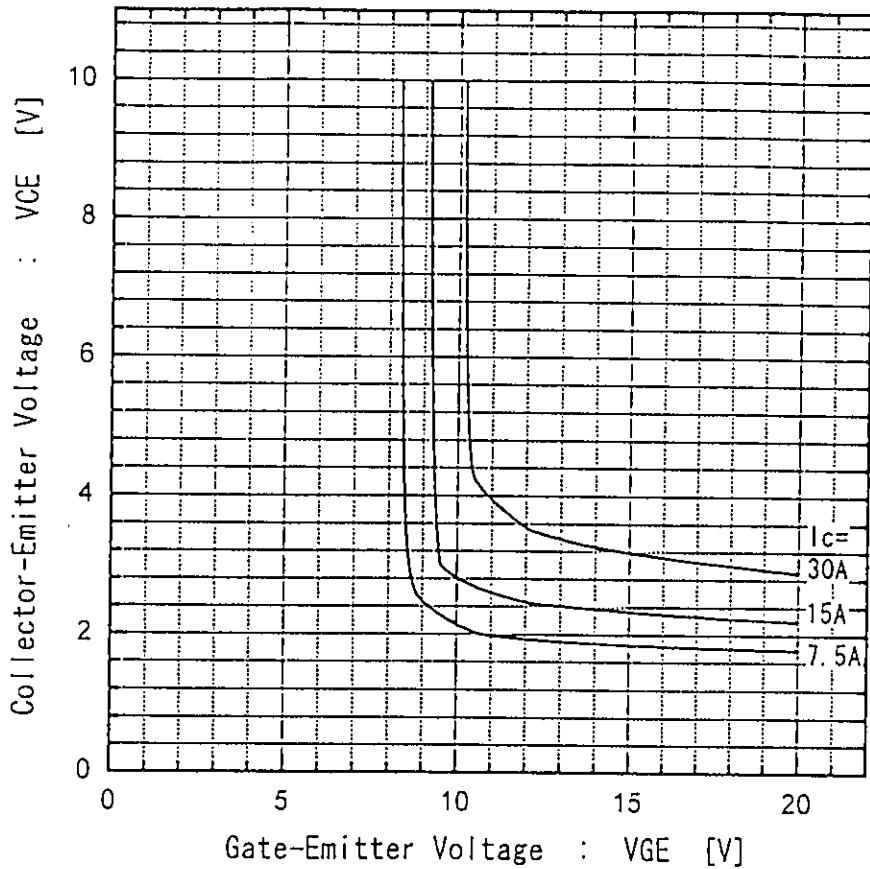

Collector-Emitter Voltage vs Gate-Emitter Voltage
 $T_j=125^\circ\text{C}$

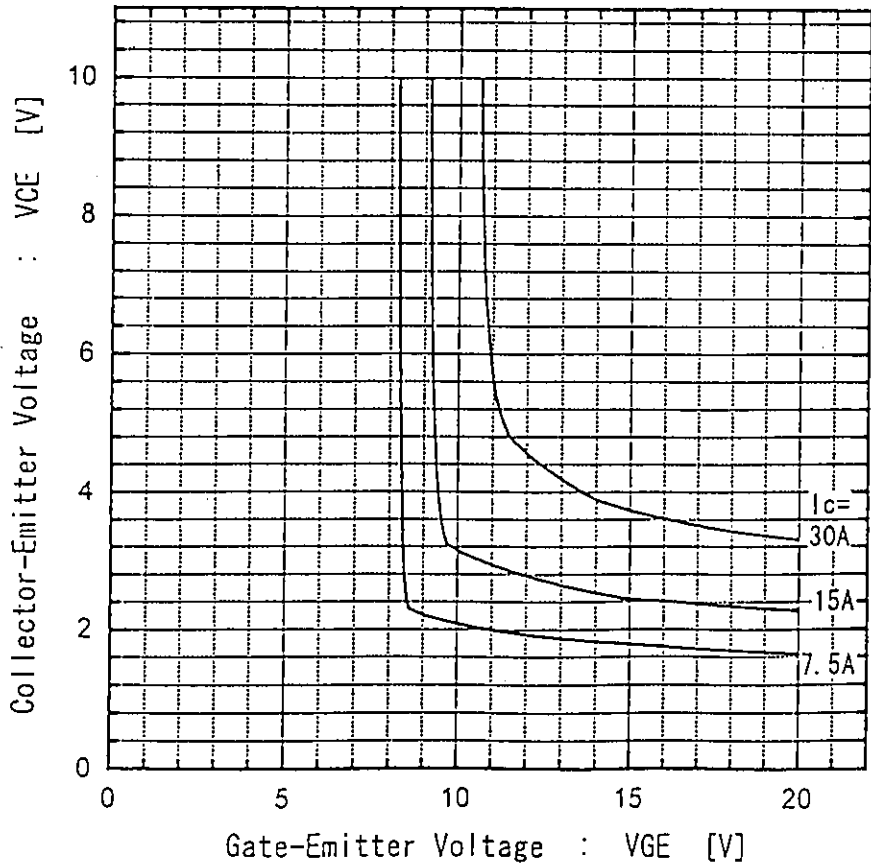

This material and the information herein is the property of Fuji Electric Co., Ltd. They shall be neither reproduced, copied, lent, or disclosed in any way whatsoever for the use of any third party nor used for the manufacturing purposes without the express written consent of Fuji Electric Co., Ltd.

Switching time vs. Collector current
 $V_{CC}=300V, R_G=16\Omega, V_{GE}=\pm 15V, T_j=25^\circ C$

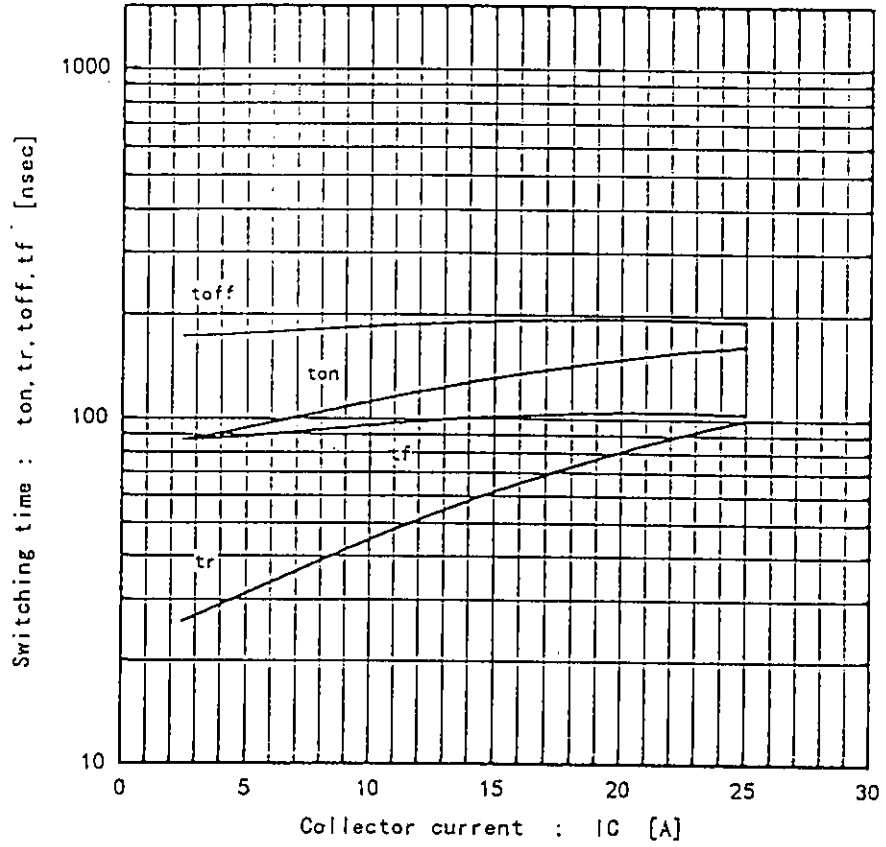

Switching time vs. Collector current
 $V_{CC}=300V, R_G=16\Omega, V_{GE}=\pm 15V, T_j=125^\circ C$

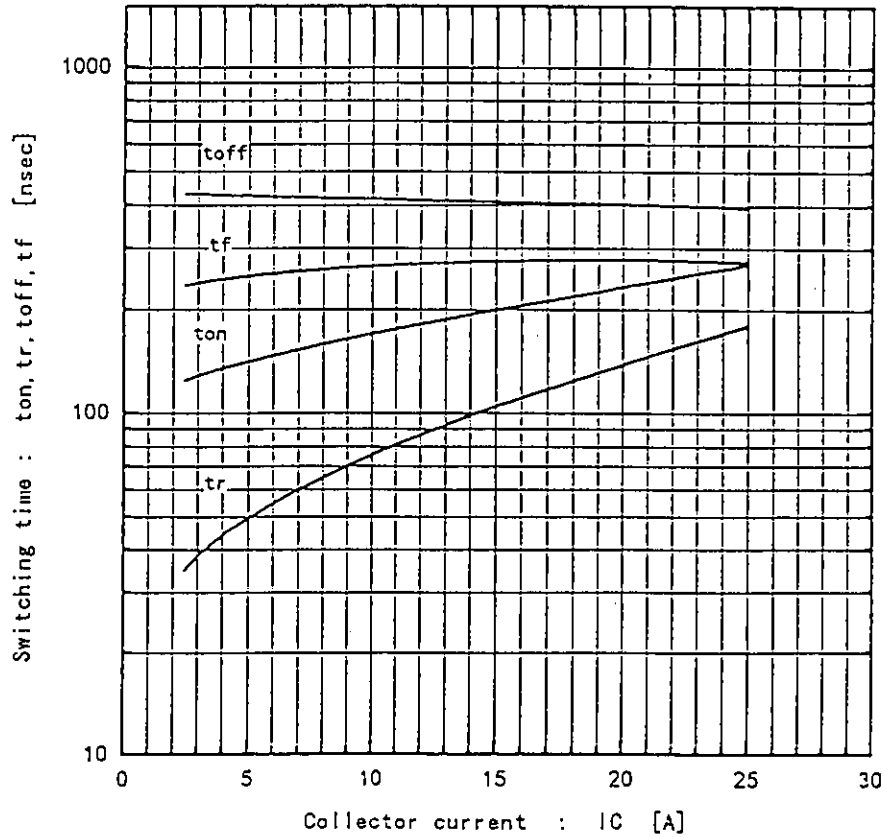

This material and the information herein is the property of Fuji Electric Co. Ltd. They shall be neither reproduced, copied, lent, or disclosed in any way whatsoever for the use of any third party nor used for the manufacturing purposes without the express written consent of Fuji Electric Co., Ltd.

Switching time vs. RG
 $V_{cc}=300V, I_C=15A, V_{GE}=\pm 15V, T_j=25^\circ C$

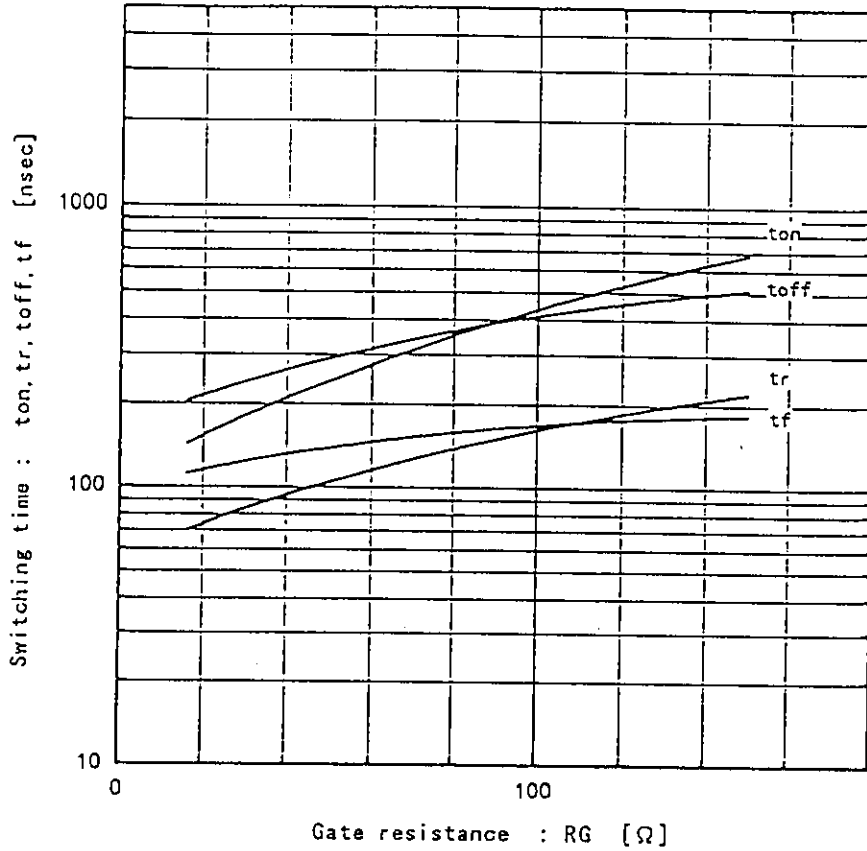

Switching time vs. RG
 $V_{cc}=300V, I_C=15A, V_{GE}=\pm 15V, T_j=125^\circ C$

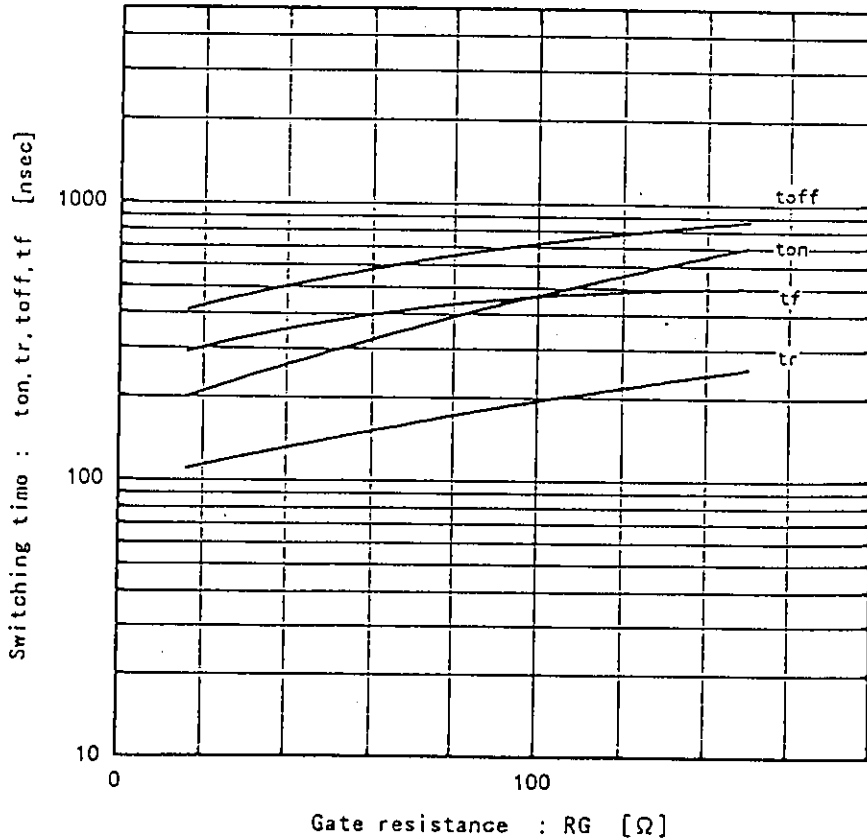

This material and the information herein is the property of Fuji Electric Co., Ltd. They shall be neither reproduced, copied, lent, or disclosed in any way whatsoever for the use of any third party nor used for the manufacturing purposes without the express written consent of Fuji Electric Co., Ltd.

Dynamic input characteristics

$T_j = 25^\circ\text{C}$

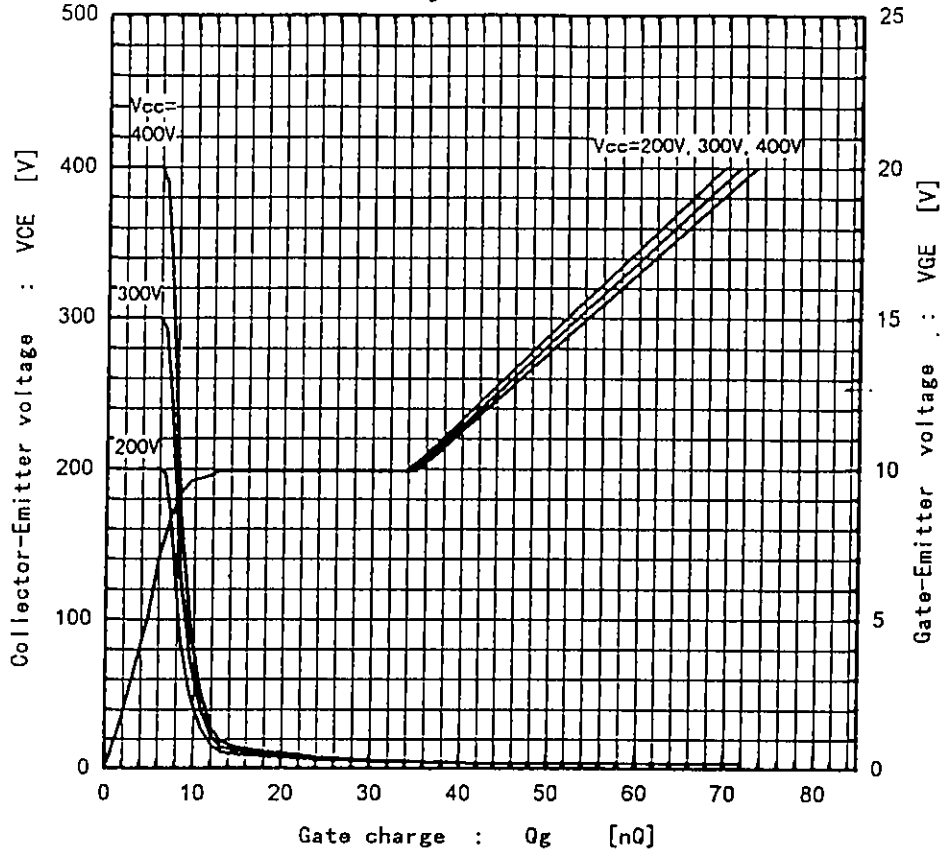

Capacitance vs. Collector-Emmitter voltage

$T_j = 25^\circ\text{C}$

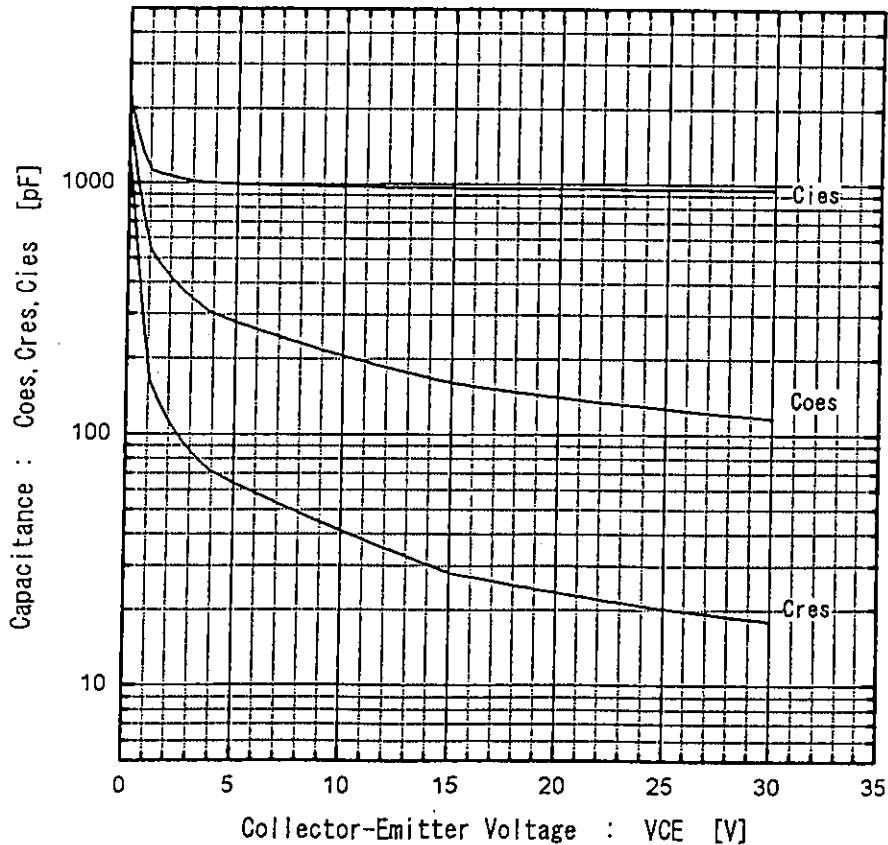

Reverse Biased Safe Operating Area
 $+V_{GE}=15V, -V_{GE} \leq 15V, T_j \leq 125^\circ C, R_g \geq 16\Omega$

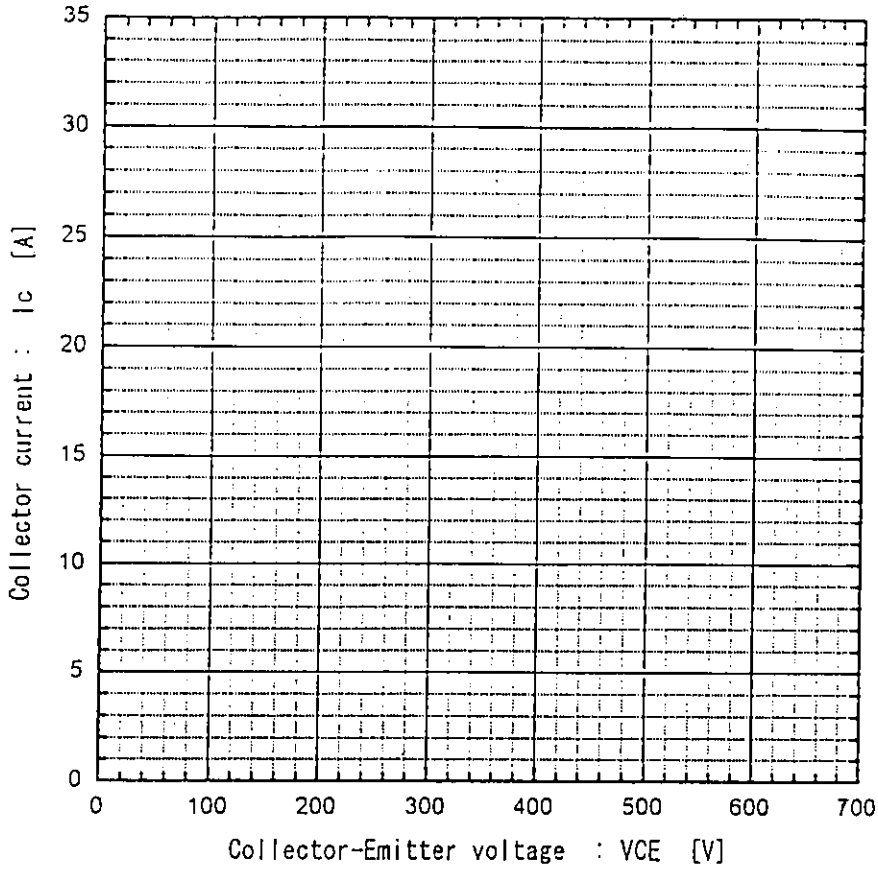

Typical short circuit capability
 $V_{cc}=400V, R_g=16\Omega, T_j=125^\circ C$

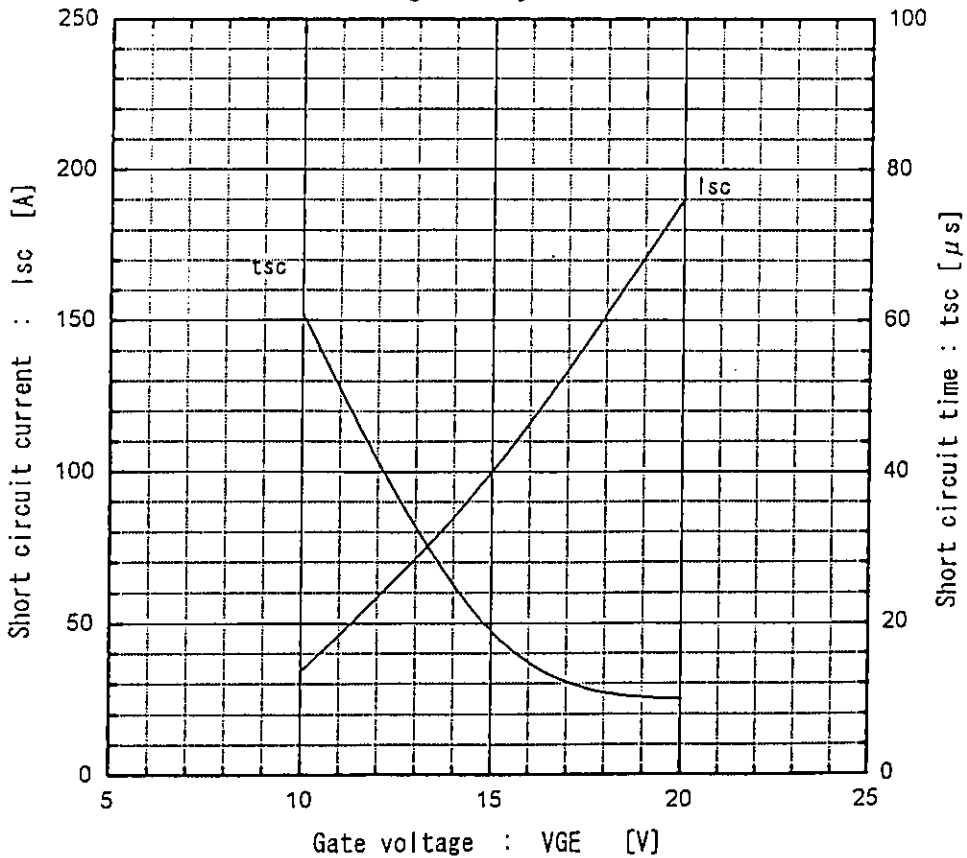

This material and the information herein is the property of Fuji Electric Co., Ltd. It shall be neither reproduced, copied, lent, or disclosed in any way whatsoever for the use of any third party nor used for the manufacturing purposes without the express written consent of Fuji Electric Co., Ltd.

This material and the information herein is the property of Fuji Electric Co., Ltd. They shall be neither reproduced, copied, lent, or disclosed in any way whatsoever for the use of any third party nor used for the manufacturing purposes without the express written consent of Fuji Electric Co., Ltd.

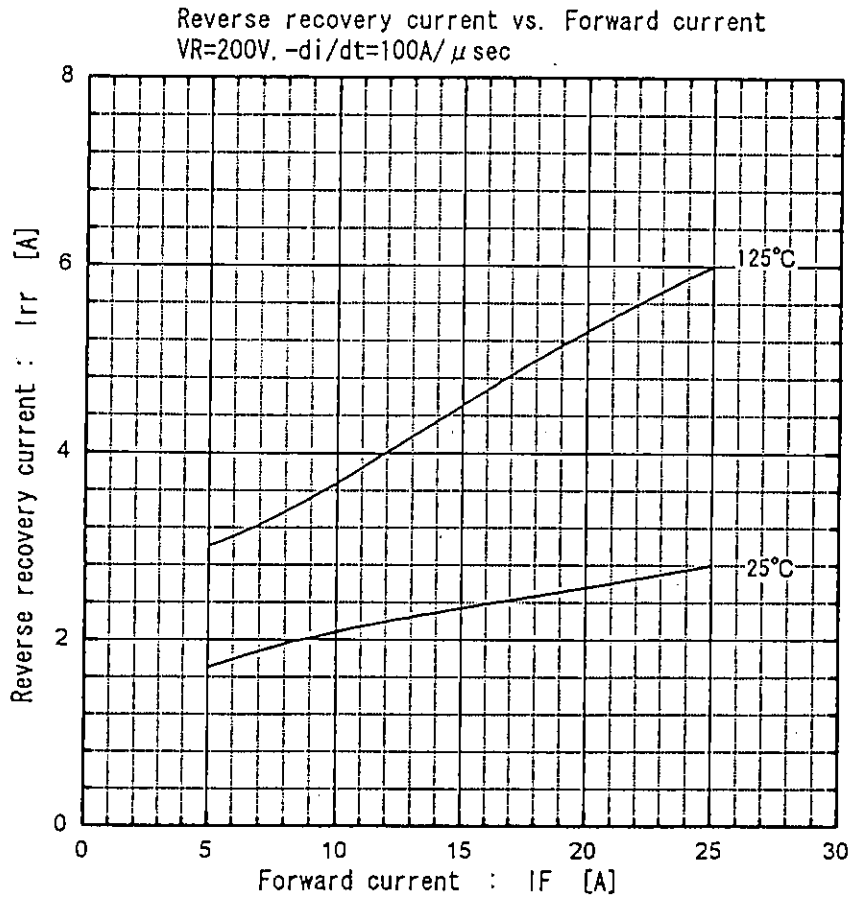
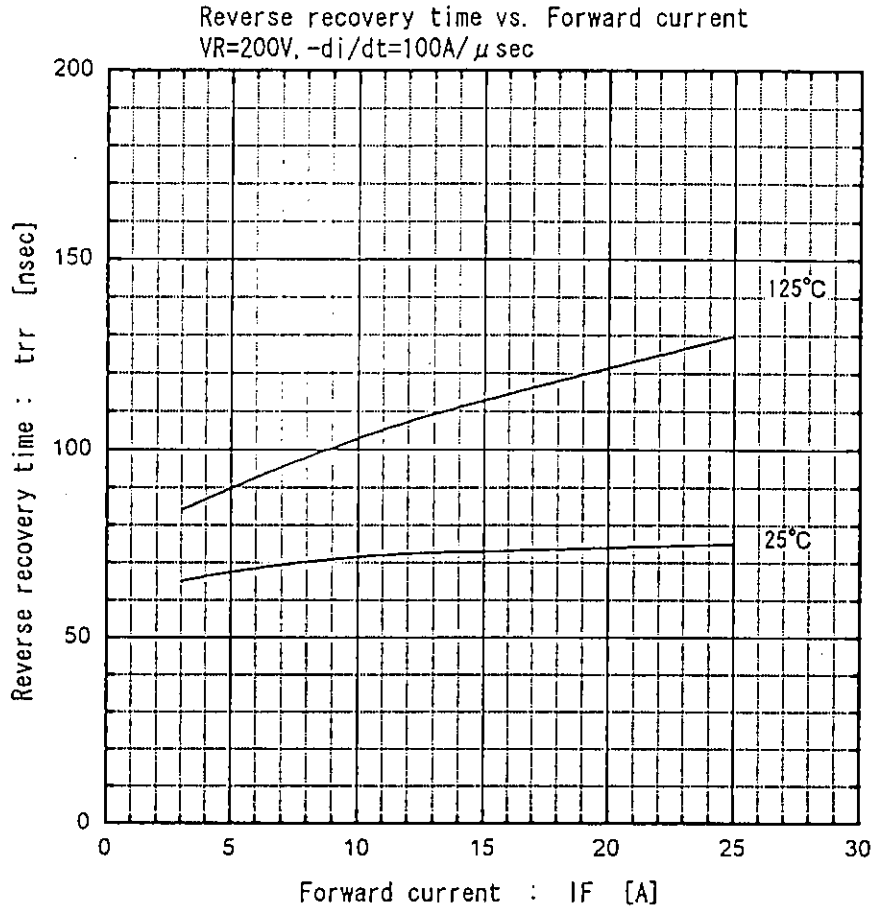

This material and the information herein is the property of Fuji Electric Co., Ltd. They shall be neither reproduced, copied, lent, or disclosed in any way whatsoever for the use of any third party nor used for the manufacturing purposes without the express written consent of Fuji Electric Co., Ltd.

Forward voltage vs. Forward current

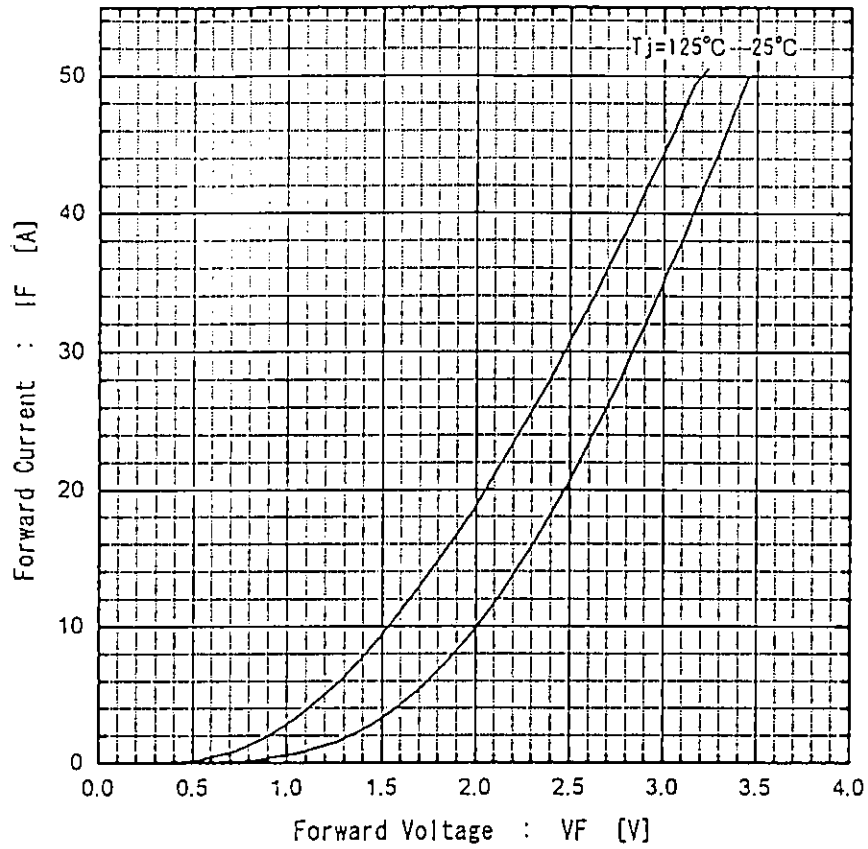

Reverse recovery characteristics vs. $-di/dt$
IF=15A, Tj=125°C

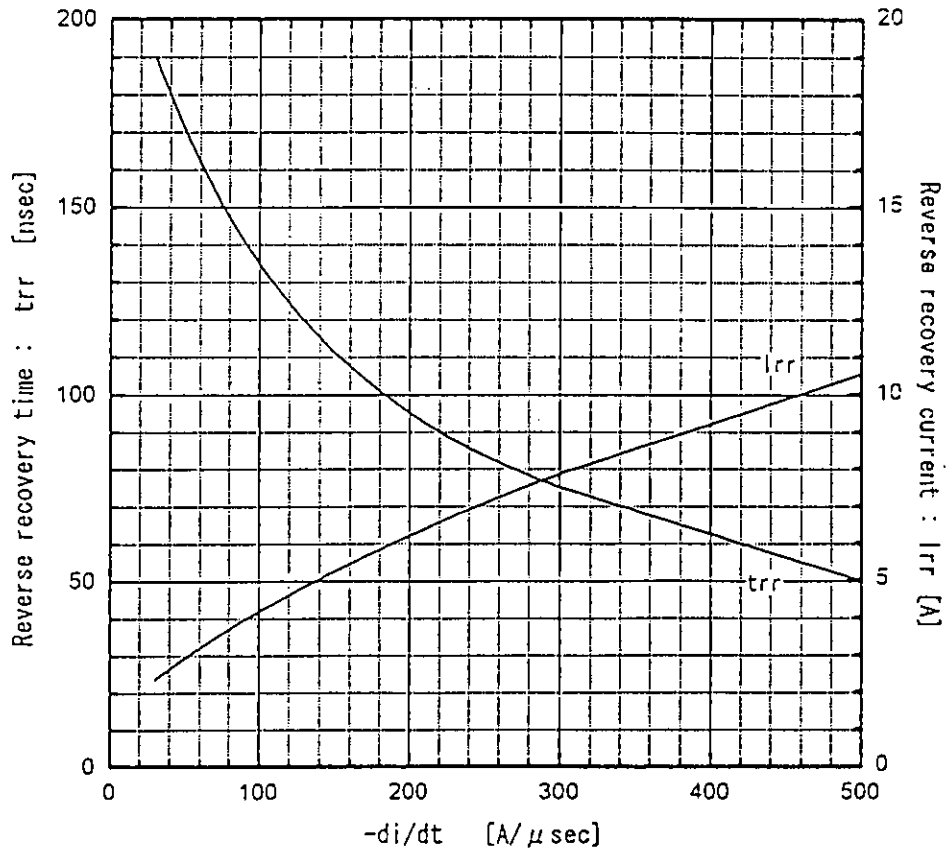

This material and the information herein is the property of Fuji Electric Co., Ltd. They shall be neither reproduced, copied, lent, or disclosed in any way whatsoever for the use of any third party nor used for the manufacturing purposes without the express written consent of Fuji Electric Co., Ltd.

Transient thermal resistance

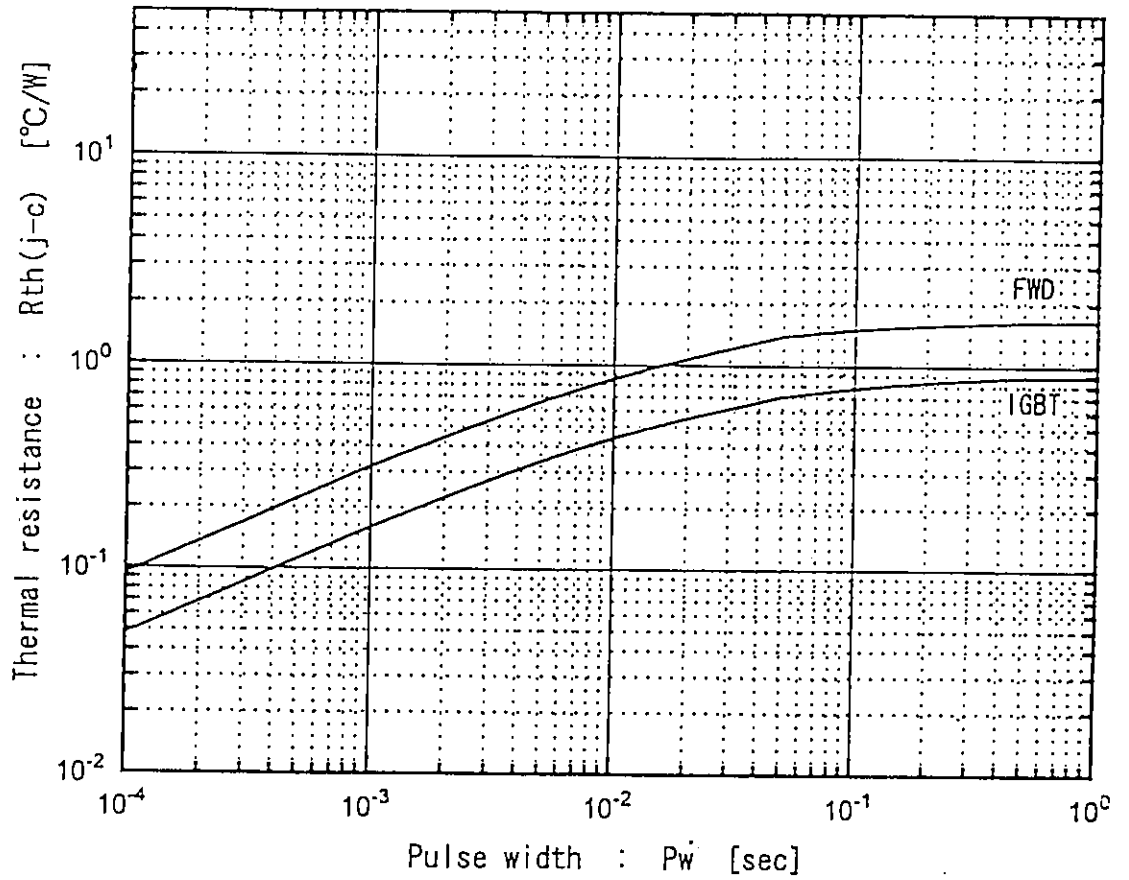

For more information, contact:

Collmer Semiconductor, Inc.

P.O. Box 702708

Dallas, TX 75370

972-733-1700

972-381-9991 Fax

<http://www.collmer.com>