

IGBT MODULE (N series)

Outline Drawing

Features

- Square RBSOA
- Low Saturation Voltage
- Overcurrent Limiting Function (~3 Times Rated Current)

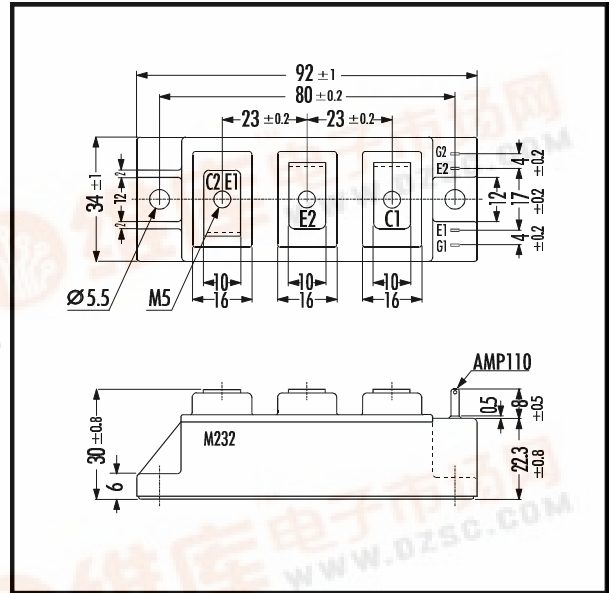

Maximum Ratings and Characteristics

Equivalent Circuit

Absolute Maximum Ratings (T_c=25°C)

Items	Symbols	Rated Values	Units
Collector-Emmitter Voltage	V _{CE} S	600	V
Gate -Emmitter Voltage	V _{GES}	± 20	V
Collector Current	Continuous	I _C	150
	1ms	I _C PULSE	300
	Continuous	-I _C	150
	1ms	-I _C PULSE	300
Max. Power Dissipation	P _C	600	W
Operating Temperature	T _j	+150	°C
Storage Temperature	T _{stg}	-40 ~ +125	°C
Isolation Voltage	A.C. 1min.	V _{is}	2500
Screw Torque	Mounting *1	3.5	Nm
	Terminals *1	3.5	

Note: *1:Recommendable Value; 2.5 ~ 3.5 Nm (M5)

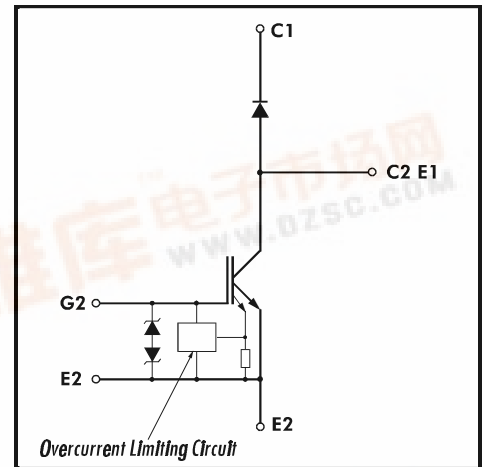

Electrical Characteristics (at T_j=25°C)

Items	Symbols	Test Conditions	Min.	Typ.	Max.	Units
Zero Gate Voltage Collector Current	I _{CE} S	V _{GE} =0V V _{CE} =600V			1.0	mA
Gate-Emmitter Leakage Current	I _{GES}	V _{CE} =0V V _{GE} =± 20V			15	µA
Gate-Emmitter Threshold Voltage	V _{GE(th)}	V _{GE} =20V I _C =150mA	4.5		7.5	V
Collector-Emmitter Saturation Voltage	V _{CE(sat)}	V _{GE} =15V I _C =150A			2.8	V
Input capacitance	C _{ies}	V _{GE} =0V		9900		pF
Output capacitance	C _{oes}	V _{CE} =10V		2200		
Reverse Transfer capacitance	C _{res}	f=1MHz		1000		
Turn-on Time	t _{ON}	V _{CC} =300V		0.6	1.2	µs
	t _r	I _C =150A		0.2	0.6	
Turn-off Time	t _{OFF}	V _{GE} =± 15V		0.6	1.0	
	t _f	R _G =16Ω		0.2	0.35	
Diode Forward On-Voltage	V _F	I _F =150A V _{GE} =0V			3.0	V
Reverse Recovery Time	t _{rr}	I _F =150A			300	ns
Reverse Current	I _{RRM}	V _R =600V			1.0	mA

Thermal Characteristics

Items	Symbols	Test Conditions	Min.	Typ.	Max.	Units
Thermal Resistance	R _{th(j-c)}	IGBT			0.21	°C/W
	R _{th(j-e)}	Diode			0.47	
	R _{th(c-f)}	With Thermal Compound		0.05		



Collector current vs. Collector-Emittor voltage
 $T_j=25^\circ\text{C}$

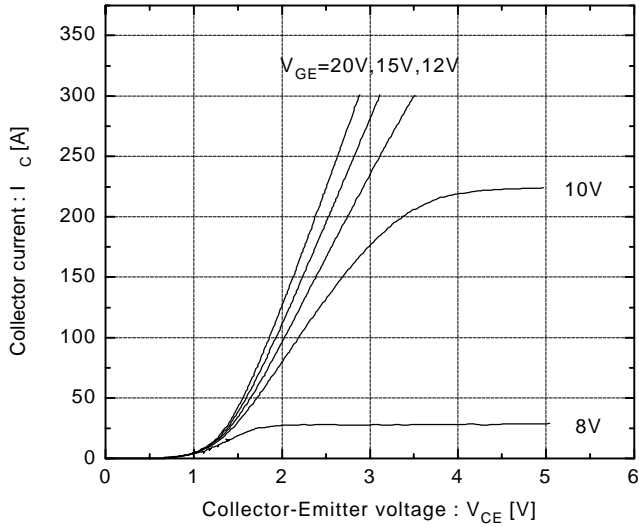

Collector current vs. Collector-Emittor voltage
 $T_j=125^\circ\text{C}$

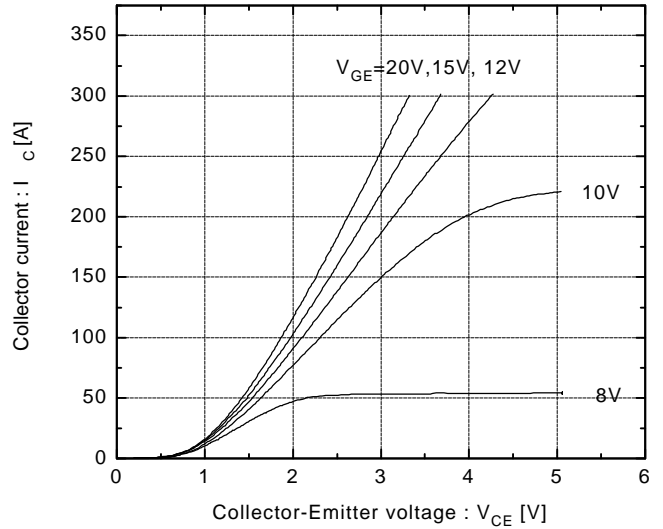

Collector-Emittor vs. Gate-Emittor voltage
 $T_j=25^\circ\text{C}$

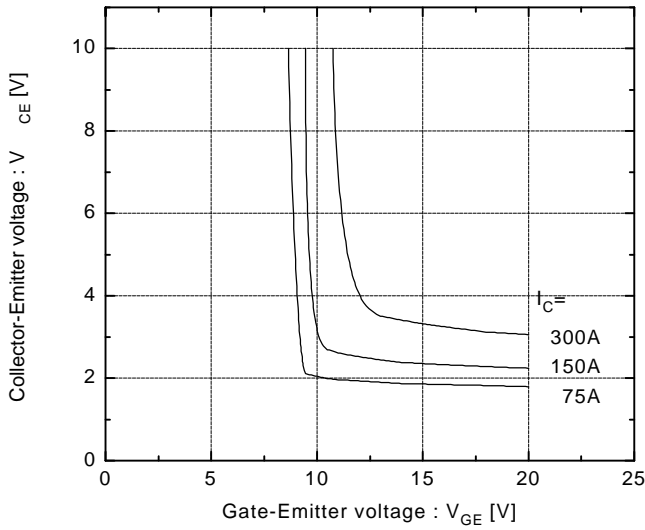

Collector-Emittor vs. Gate-Emittor voltage
 $T_j=125^\circ\text{C}$

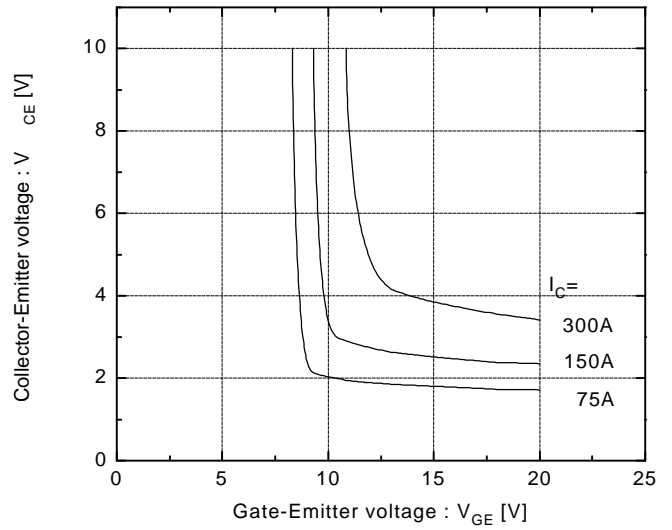

Switching time vs. Collector current
 $V_{CC}=300\text{V}, R_G=16\Omega, V_{GE}=\pm 15\text{V}, T_j=25^\circ\text{C}$

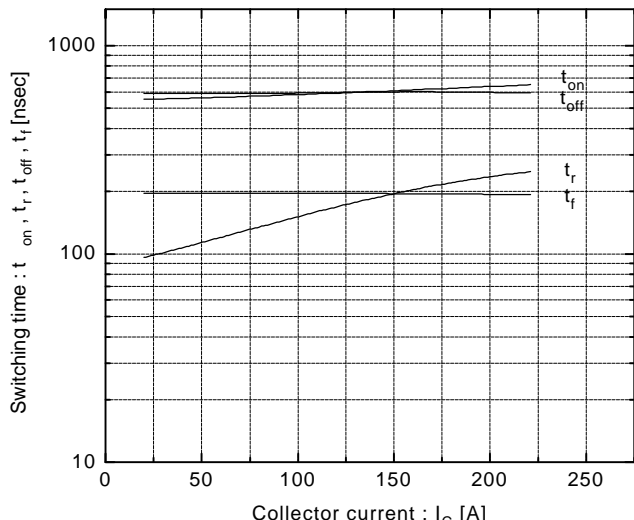

Switching time vs. Collector current
 $V_{CC}=300\text{V}, R_G=16\Omega, V_{GE}=\pm 15\text{V}, T_j=125^\circ\text{C}$

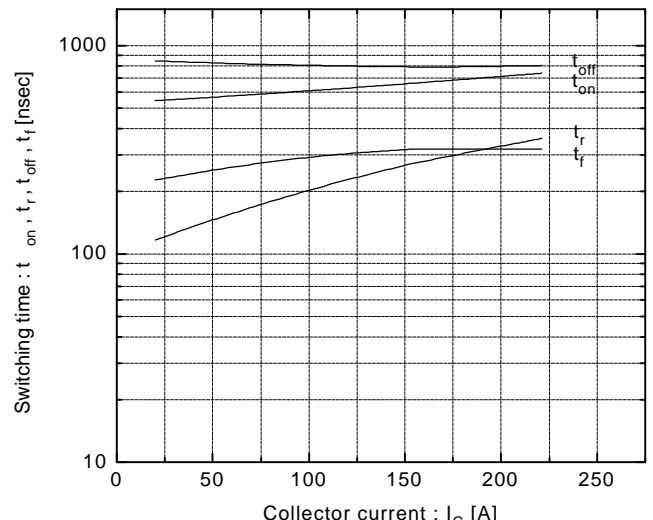

Switching time vs. R_G

$V_{CC}=300V, I_C=150A, V_{GE}=\pm 15V, T_J=25^\circ C$

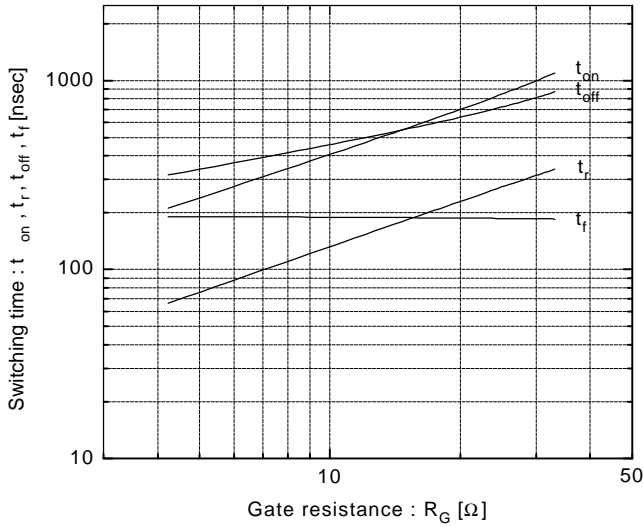

Dynamic input characteristics

$T_J=25^\circ C$

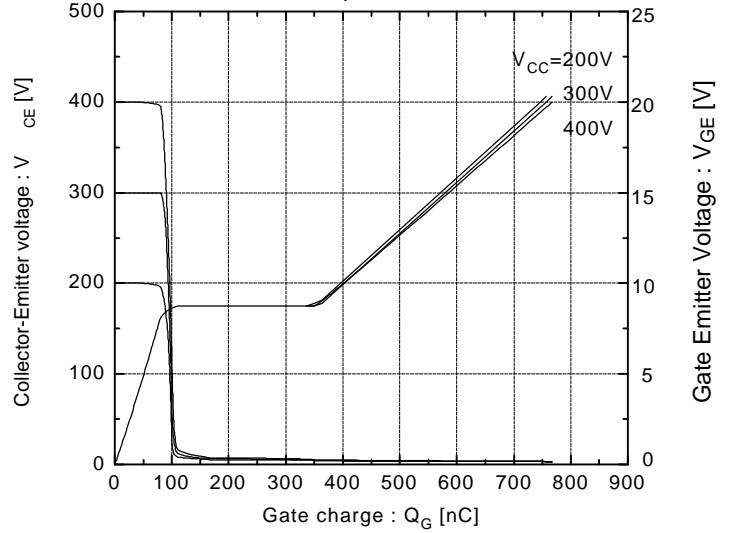

Forward current vs. Forward voltage

$V_{GE}=0V$

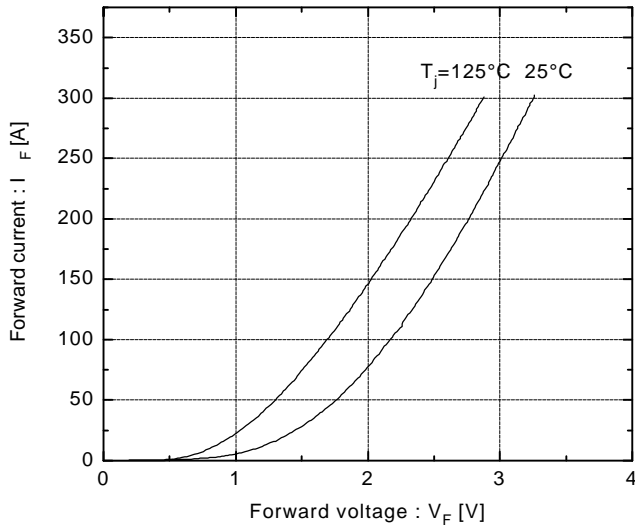

Reverse recovery characteristics

t_{rr}, I_{rr} vs. I_F

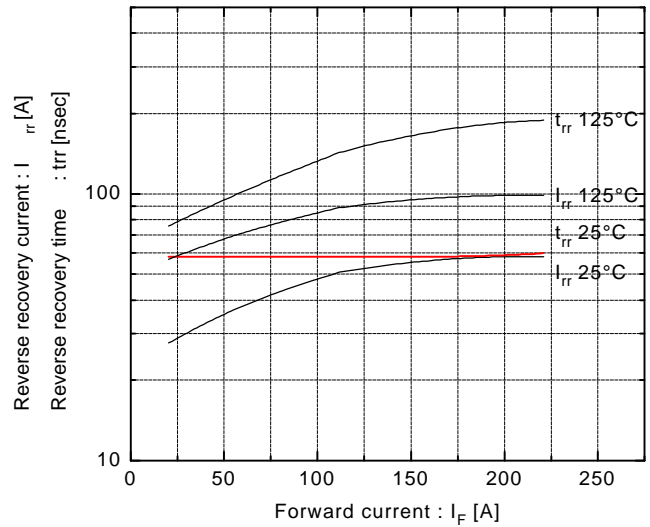

Transient thermal resistance

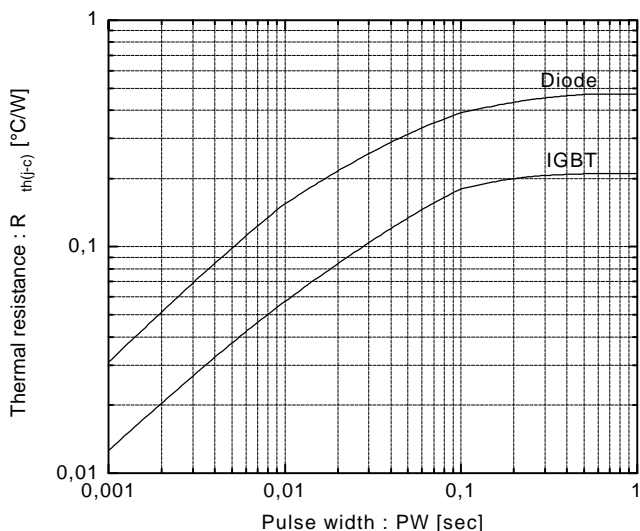

Reversed biased safe operating area
 $+V_{GE}=15V, -V_{GE}\leq 15V, T_J\leq 125^\circ C, R_G\geq 16\Omega$

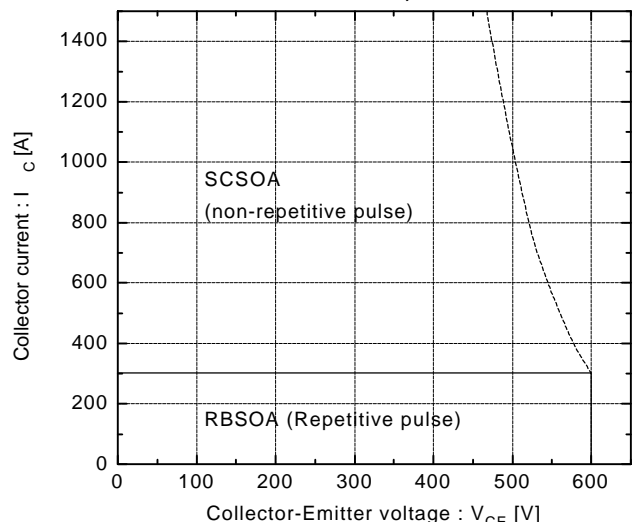

Switching loss vs. Collector current
 $V_{CC}=300V, R_G=16\Omega, V_{GE}=\pm 15V$

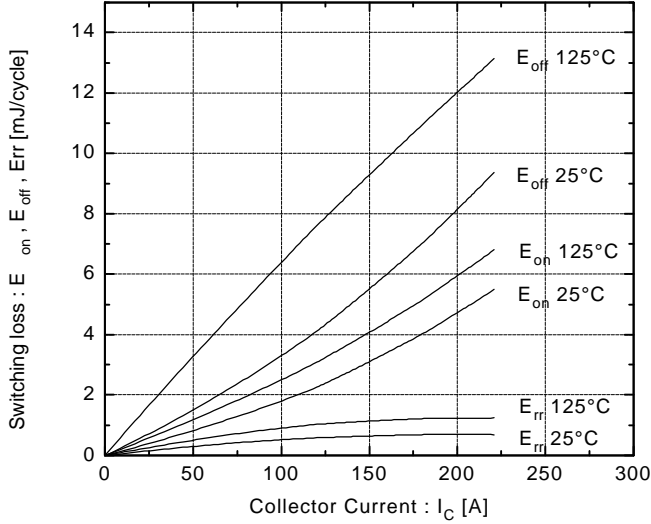

Capacitance vs. Collector-Emitter voltage
 $T_j=25^\circ C$

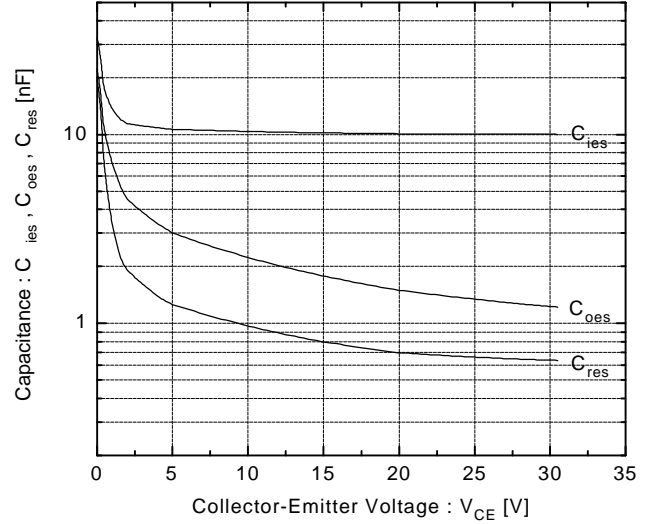

Fuji Electric GmbH

Lyoner Straße 26

D-60528 Frankfurt/M

Tel.: 069 - 66 90 29 - 0

Fax.: 069 - 66 90 29 - 56

Fuji Electric (UK) Ltd.

Commonwealth House
 2 Chalkhill Road Hammersmith

London W6 8DW, UK

Tel.: 0181 - 233 11 30

Fax.: 0181 - 233 11 60