

SONY

1T405A

Variable Capacitance Diode

Description

The 1T405A is a variable capacitance diode designed for electronic tuning of wide-band CATV tuners using a super-small-miniature flat package (SSVC).

High capacitance ratio (C25/C28) is improved to support guard band.

Features

- Super-small-miniature flat package
- Low series resistance 0.85 Ω Max. (f=470 MHz)
- Large capacitance ratio 12.5 Typ. (C2/C25)
1.03 Min. (C25/C28)
- Small leakage current 10 nA Max. (VR=28 V)
- Capacitance deviation within 2 %

Applications

Electronic tuning of VHF band and wide-band CATV tuners

Structure

Silicon epitaxial planar type diode

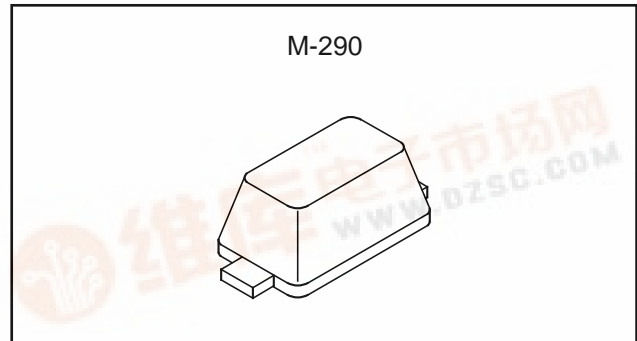

Absolute Maximum Ratings (Ta=25 °C)

- Reverse voltage VR 34 V
- Operating temperature Topr -20 to +75 °C
- Storage temperature Tstg -65 to +150 °C

Electrical Characteristics

(Ta=25 °C)

Item	Symbol	Conditions	Min.	Typ.	Max.	Unit
Reverse current	IR	VR=28 V			10	nA
Reverse voltage	VR	IR=1 μA	34			V
Diode capacitance	C2	VR=2 V, f=1 MHz	32.96		38.96	pF
	C25	VR=25 V, f=1 MHz	2.53		2.96	pF
Capacitance ratio	C2/C25		12.0	12.5		
	C25/C28		1.03			
Series resistance	rs	CD=14 pF, f=470 MHz			0.85	Ω
Capacitance deviation in a matching group	ΔC	VR=2 to 25 V, f=1 MHz			2	%

The continuous 20 pieces of ΔC are guaranteed.



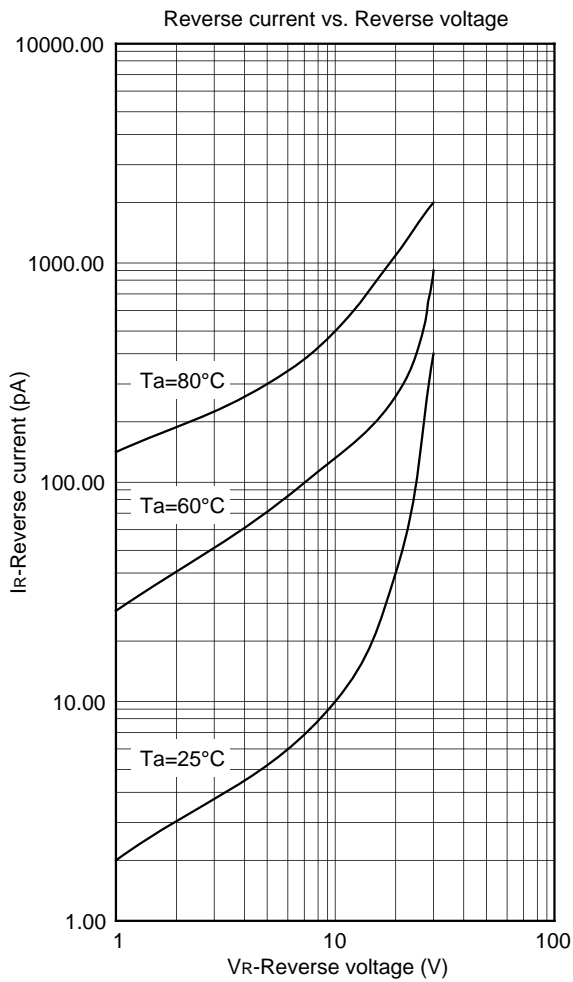
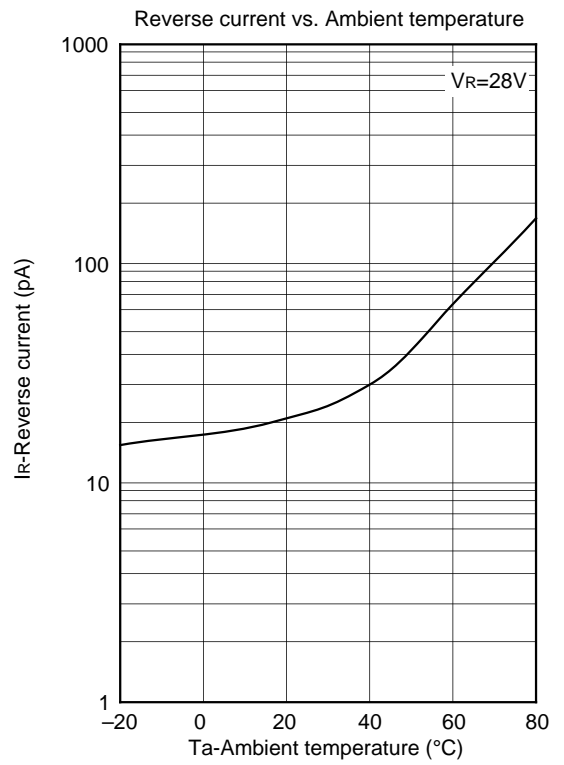
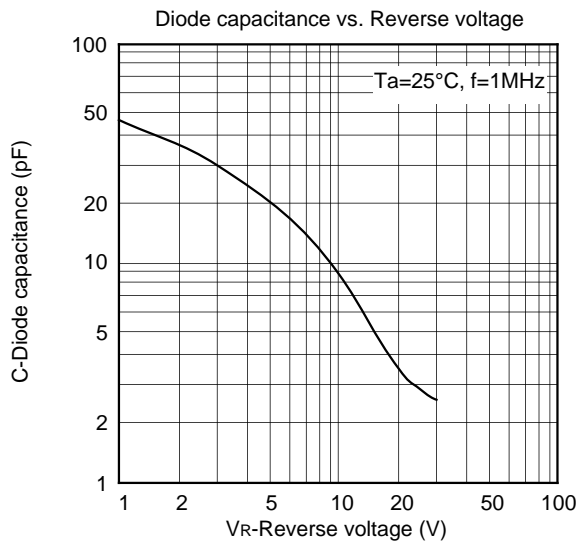

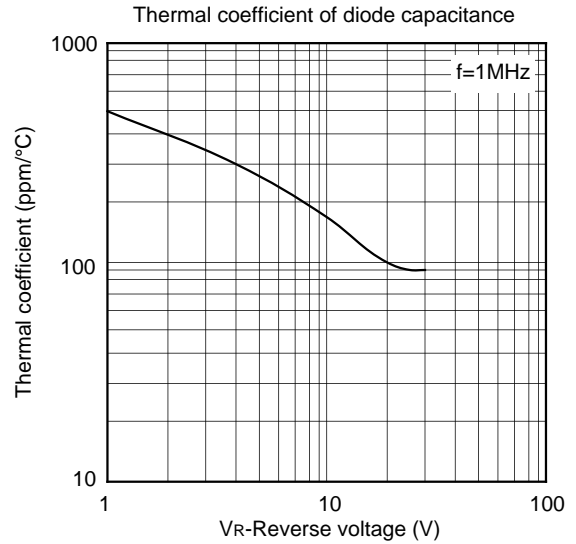
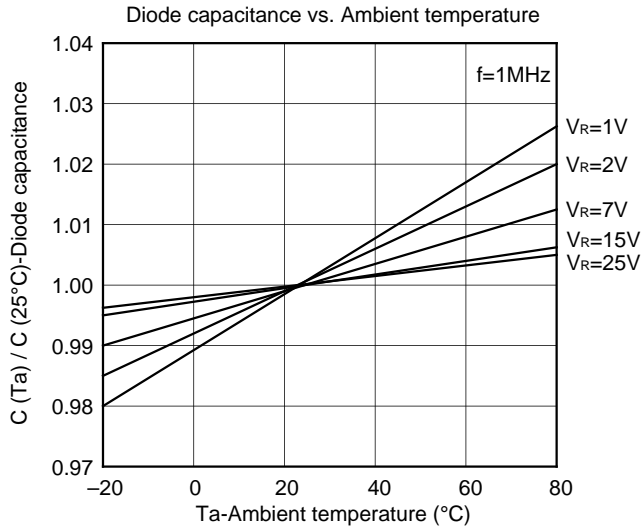
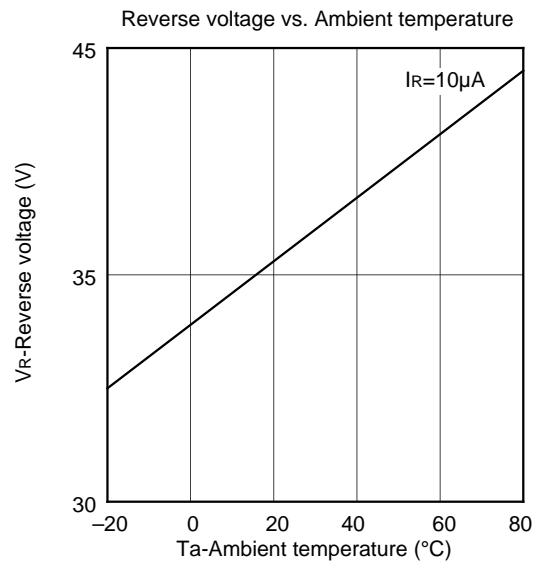
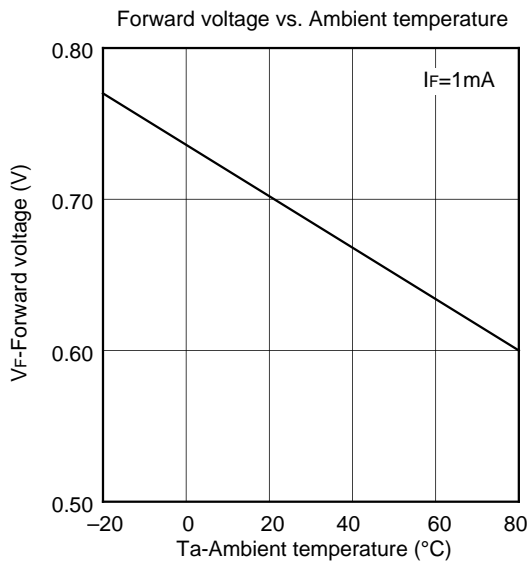

Package Outline Unit : mm

M-290

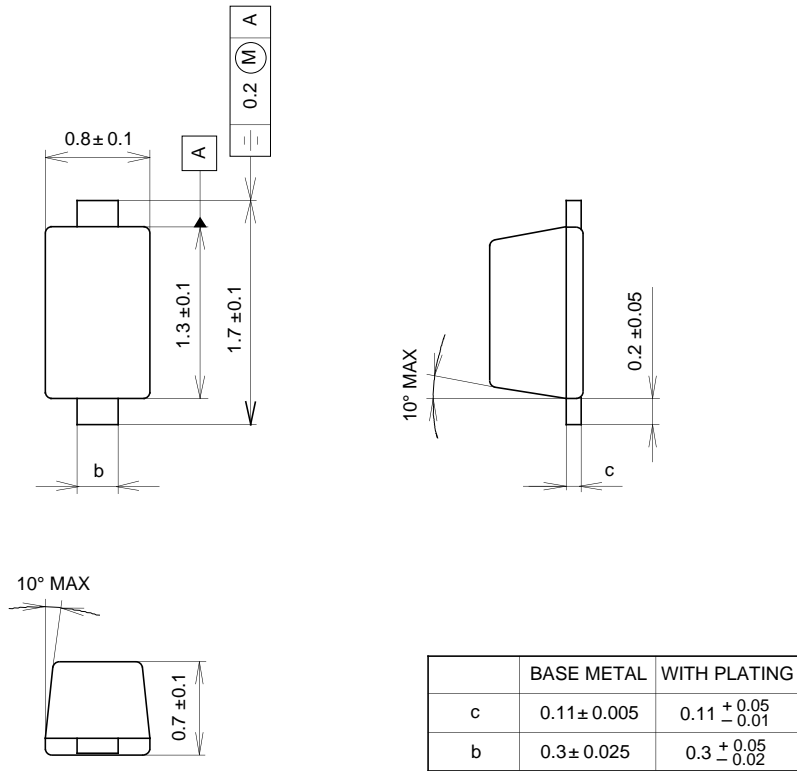

SONY CODE	M-290
EIAJ CODE	_____
JEDEC CODE	_____

PACKAGE MATERIAL	EPOXY RESIN
LEAD TREATMENT	SOLDER PLATING
LEAD MATERIAL	COPPER
PACKAGE WEIGHT	0.002g

MARK

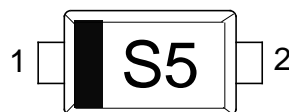

1 : Cathode
2 : Anode