



September 2006

KSC1008

NPN Epitacial Silicon Transistor

Features

- Low frequency amplifier medium speed switching.
- High Collector-Base Voltage : $V_{CBO}=80V$.
- Collector Current : $I_C=700mA$
- Collector Power Dissipation : $P_C=800mW$
- Suffix "-C" means Center Collector (1.Emitter 2.Collector 3.Base)
- Non suffix "-C" means Side Collector (1.Emitter 2.Base 3.Collector)
- Complement to KSA708

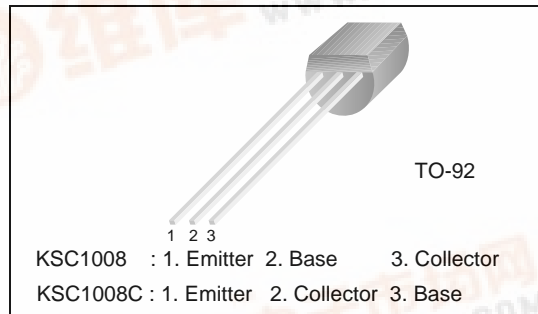

Absolute Maximum Ratings * $T_a = 25^\circ C$ unless otherwise noted

Symbol	Parameter	Value	Units
V_{CBO}	Collector-Base Voltage	80	V
V_{CEO}	Collector-Emitter Voltage	60	V
V_{EBO}	Emitter-Base Voltage	8	V
I_C	Collector current	700	mA
P_C	Collector Power Dissipation	800	mW
T_J	Junction Temperature	+150	$^\circ C$
T_{stg}	Storage Temperature	-55 ~ +150	$^\circ C$

- * 1. These ratings are limiting values above which the serviceability of any semiconductor device may be impaired.
2. These are steady state limits. The factory should be consulted on applications involving pulsed or low duty cycle operations.

Electrical Characteristics * $T_a = 25^\circ C$ unless otherwise noted

Symbol	Parameter	Test Condition	Min.	Typ.	Max.	Units
BV_{CBO}	Collector-Base Breakdown Voltage	$I_C=100\mu A, I_E=0$	80			V
BV_{CEO}	Collector-Emitter Breakdown Voltage	$I_C=10mA, I_B=0$	60			V
BV_{EBO}	Emitter-Base Breakdown Voltage	$I_E=10\mu A, I_C=0$	8			V
I_{CBO}	Collector Cut-off Current	$V_{CB}=60V, I_E=0$			0.1	μA
I_{EBO}	Emitter Cut-off Current	$V_{EB}=5V, I_C=0$			0.1	μA
h_{FE}	DC Current Gain	$V_{CE}=2V, I_C=50mA$	40		400	
$V_{CE(sat)}$	Collector-Emitter Saturation Voltage	$I_C=500mA, I_B=50mA$		0.2	0.4	V
$V_{BE(sat)}$	Base-Emitter Saturation Voltage	$I_C=500mA, I_B=50mA$		0.86	1.1	V
f_T	Current Gain Bandwidth Product	$V_{CE}=10V, I_C=50mA$	30	50		MHz
C_{ob}	Output Capacitance	$V_{CB}=10V, I_E=0, f=1MHz$		8		pF

* DC Item are tested by Pulse Test: Pulse Width $\leq 300\mu s$, Duty Cycle $\leq 2\%$

h_{FE} Classification

Classification	R	O	Y	G
h_{FE}	40 ~ 80	70 ~ 140	120 ~ 240	200 ~ 400



Package Marking and Ordering Information

Device ^(note)	Device Marking	Package	Packing Method	Qty(pcs)	Pin Definitions
KSC1008COBU	C1008OC	TO-92	BULK	--	1.Emitter 2.Collector 3.Base
KSC1008COTA	C1008OC	TO-92	TAPE & AMMO	2,000	1.Emitter 2.Collector 3.Base
KSC1008CYBU	C1008YC	TO-92	BULK	--	1.Emitter 2.Collector 3.Base
KSC1008CYTA	C1008YC	TO-92	TAPE & AMMO	2,000	1.Emitter 2.Collector 3.Base
KSC1008GBU	C1008G	TO-92	BULK	--	1.Emitter 2.Base 3.Collector
KSC1008GTA	C1008G	TO-92	TAPE & AMMO	2,000	1.Emitter 2.Base 3.Collector
KSC1008OBU	C1008O	TO-92	BULK	--	1.Emitter 2.Base 3.Collector
KSC1008OTA	C1008O	TO-92	TAPE & AMMO	2,000	1.Emitter 2.Base 3.Collector
KSC1008RBU	C1008R	TO-92	BULK	--	1.Emitter 2.Base 3.Collector
KSC1008RTA	C1008R	TO-92	TAPE & AMMO	2,000	1.Emitter 2.Base 3.Collector
KSC1008YBU	C1008Y	TO-92	BULK	--	1.Emitter 2.Base 3.Collector
KSC1008YTA	C1008Y	TO-92	TAPE & AMMO	2,000	1.Emitter 2.Base 3.Collector
KSC1008YTF	C1008Y	TO-92	TAPE & REEL	2,000	1.Emitter 2.Base 3.Collector

Note : Affix "-C-" - center collector pin.
 Affix "-R-, -O-, -Y-, -G-" - h_{FE} classification
 Suffix "-BU" - Bulk packing, straight lead form.(see package dimensions)
 Suffix "-TF" - Tape& Reel packing, 0.200 In-Line Spacing lead form. (see package dimensions)
 Suffix "-TA" - Tape& AMMO packing, 0.200 In-Line Spacing lead form. (see package dimensions)

Typical Characteristics

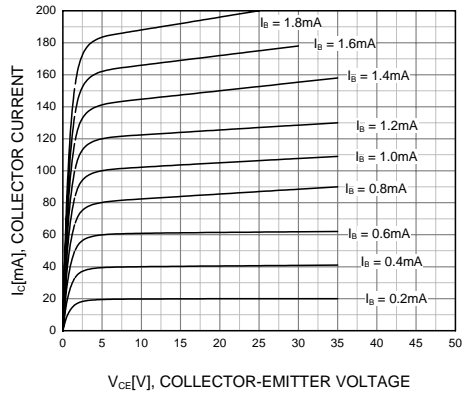

Figure 1. Static Characteristic

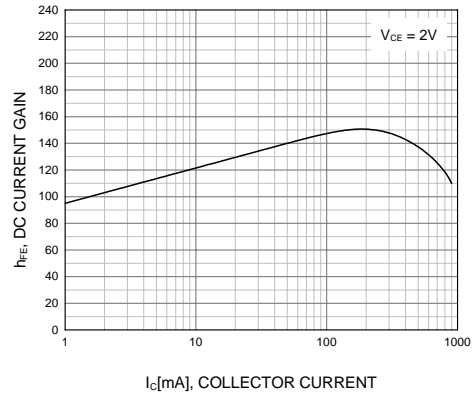

Figure 2. DC current Gain

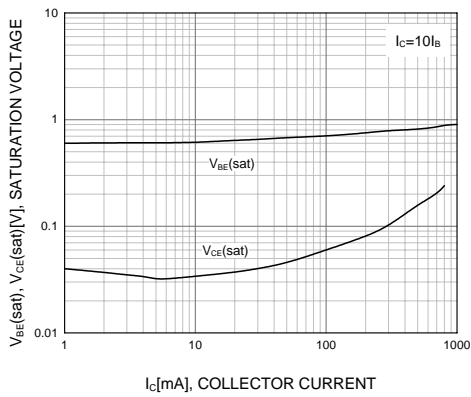

Figure 3. Base-Emitter Saturation Voltage
Collector-Emitter Saturation Voltage

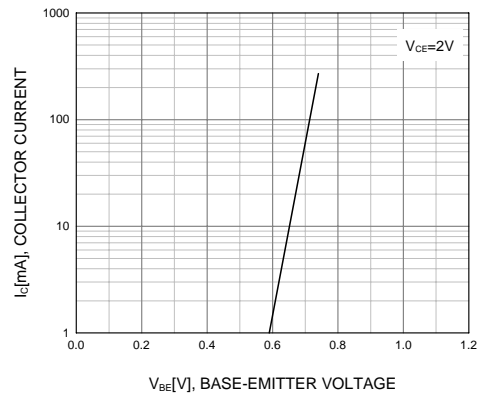

Figure 4. Base-Emitter On Voltage

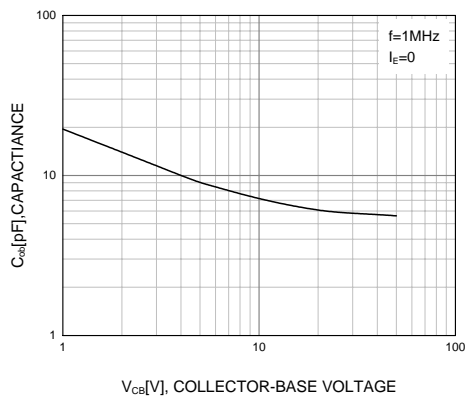
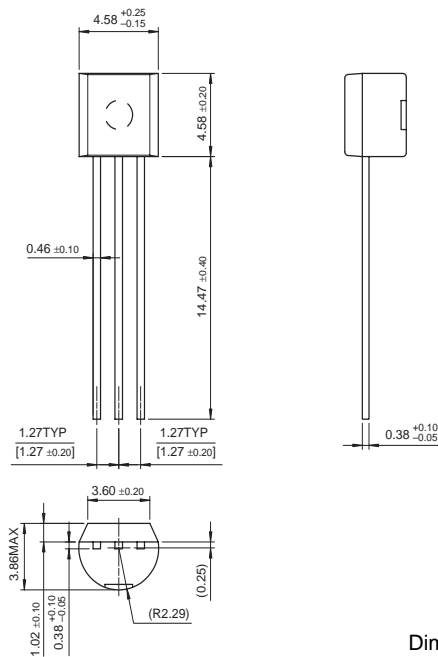

Figure 5. Collector Output Capacitance

Package Dimensions

TO-92 Straight Lead Form



Dimensions in Millimeters

TO-92 0.200 In-Line Spacing Lead Form

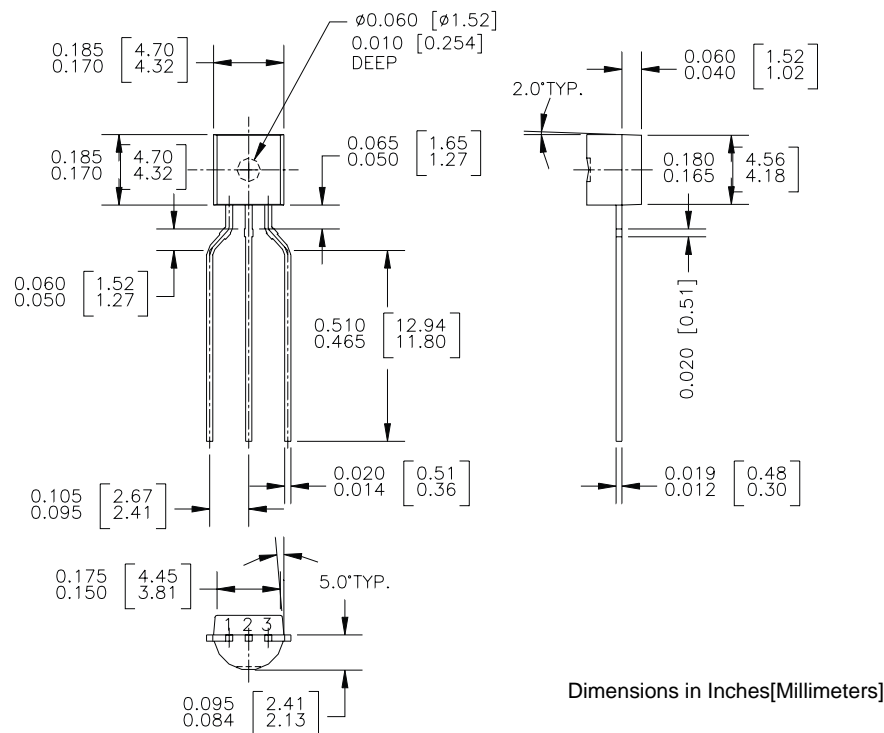

Dimensions in Inches[Millimeters]

TRADEMARKS

The following are registered and unregistered trademarks Fairchild Semiconductor owns or is authorized to use and is not intended to be an exhaustive list of all such trademarks.

ACEx™	FACT Quiet Series™	OCX™	SILENT SWITCHER®	UltraFET®
ActiveArray™	GlobalOptoisolator™	OCXPro™	SMART START™	UniFET™
Bottomless™	GTO™	OPTOLOGIC®	SPM™	VCX™
Build it Now™	HiSeC™	OPTOPLANAR™	Stealth™	Wire™
CoolFET™	I ² C™	PACMAN™	SuperFET™	
CROSSVOLT™	i-Lo™	POP™	SuperSOT™-3	
DOME™	ImpliedDisconnect™	Power247™	SuperSOT™-6	
EcoSPARK™	IntelliMAX™	PowerEdge™	SuperSOT™-8	
E ² CMOS™	ISOPLANAR™	PowerSaver™	SyncFET™	
EnSigna™	LittleFET™	PowerTrench®	TCM™	
FACT™	MICROCOUPLER™	QFET®	TinyBoost™	
FAST®	MicroFET™	QS™	TinyBuck™	
FASTr™	MicroPak™	QT Optoelectronics™	TinyPWM™	
FPS™	MICROWIRE™	Quiet Series™	TinyPower™	
FRFET™	MSX™	RapidConfigure™	TinyLogic®	
	MSXPro™	RapidConnect™	TINYOPTO™	
		µSerDes™	TruTranslation™	
		ScalarPump™	UHC™	

Across the board. Around the world.™
 The Power Franchise®
 Programmable Active Droop™

DISCLAIMER

FAIRCHILD SEMICONDUCTOR RESERVES THE RIGHT TO MAKE CHANGES WITHOUT FURTHER NOTICE TO ANY PRODUCTS HEREIN TO IMPROVE RELIABILITY, FUNCTION OR DESIGN. FAIRCHILD DOES NOT ASSUME ANY LIABILITY ARISING OUT OF THE APPLICATION OR USE OF ANY PRODUCT OR CIRCUIT DESCRIBED HEREIN; NEITHER DOES IT CONVEY ANY LICENSE UNDER ITS PATENT RIGHTS, NOR THE RIGHTS OF OTHERS. THESE SPECIFICATIONS DO NOT EXPAND THE TERMS OF FAIRCHILD'S WORLDWIDE TERMS AND CONDITIONS, SPECIFICALLY THE WARRANTY THEREIN, WHICH COVERS THESE PRODUCTS.

LIFE SUPPORT POLICY

FAIRCHILD'S PRODUCTS ARE NOT AUTHORIZED FOR USE AS CRITICAL COMPONENTS IN LIFE SUPPORT DEVICES OR SYSTEMS WITHOUT THE EXPRESS WRITTEN APPROVAL OF FAIRCHILD SEMICONDUCTOR CORPORATION.

As used herein:

- | | |
|---|---|
| <p>1. Life support devices or systems are devices or systems which, (a) are intended for surgical implant into the body, or (b) support or sustain life, or (c) whose failure to perform when properly used in accordance with instructions for use provided in the labeling, can be reasonably expected to result in significant injury to the user.</p> | <p>2. A critical component is any component of a life support device or system whose failure to perform can be reasonably expected to cause the failure of the life support device or system, or to affect its safety or effectiveness.</p> |
|---|---|

PRODUCT STATUS DEFINITIONS

Definition of Terms

Datasheet Identification	Product Status	Definition
Advance Information	Formative or In Design	This datasheet contains the design specifications for product development. Specifications may change in any manner without notice.
Preliminary	First Production	This datasheet contains preliminary data, and supplementary data will be published at a later date. Fairchild Semiconductor reserves the right to make changes at any time without notice in order to improve design.
No Identification Needed	Full Production	This datasheet contains final specifications. Fairchild Semiconductor reserves the right to make changes at any time without notice in order to improve design.
Obsolete	Not In Production	This datasheet contains specifications on a product that has been discontinued by Fairchild semiconductor. The datasheet is printed for reference information only.

Rev. I20