



HIGH CURRENT, LOW DROPOUT VOLTAGE REGULATORS

5101 SERIES

4707 Dey Road Liverpool, N.Y. 13088

(315) 701-6751

FEATURES:

- Extremely Compact 10 Pin Flatpack With Metal Base
- Extremely Low Dropout Voltage: 350mV @ 1.5 Amps
- Available in 3.3V, 5.0V, 12.0V and Adjustable Versions
- Open Collector Error Flag Output Available on Fixed Voltage Versions
- TTL Level Enable Pin: Zero Current Shutdown Mode
- Reverse Battery and Load Dump Protection
- Low Ground Current: 22mA Typical at Full Load
- 1% Guaranteed Accuracy
- Output Current to 1.5 Amps
- Contact MSK for MIL-PRF-38534 Qualification status.

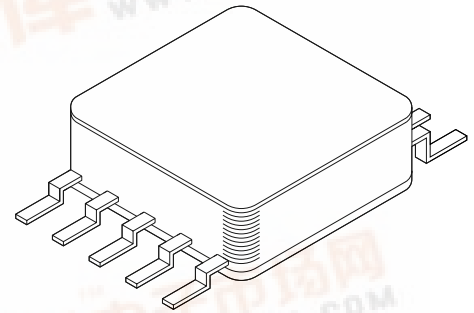

DESCRIPTION:

The MSK 5101 series voltage regulators are available in +3.3V, +5.0V, +12.0V or adjustable output configurations. All boast ultra low dropout specifications due to the utilization of a super PNP output pass transistor with monolithic technology. Dropout voltages of 350mV at 1.5 amps are typical in this configuration, which drives efficiency up and power dissipation down. Accuracy is guaranteed with a 1% output voltage tolerance. The series also offers a TTL/CMOS compatible on/off enable function as well as an output flag pin on the fixed voltage versions. The MSK 5101 series is packaged in a space efficient 10 pin ceramic flatpack with a built in metal base.

EQUIVALENT SCHEMATIC

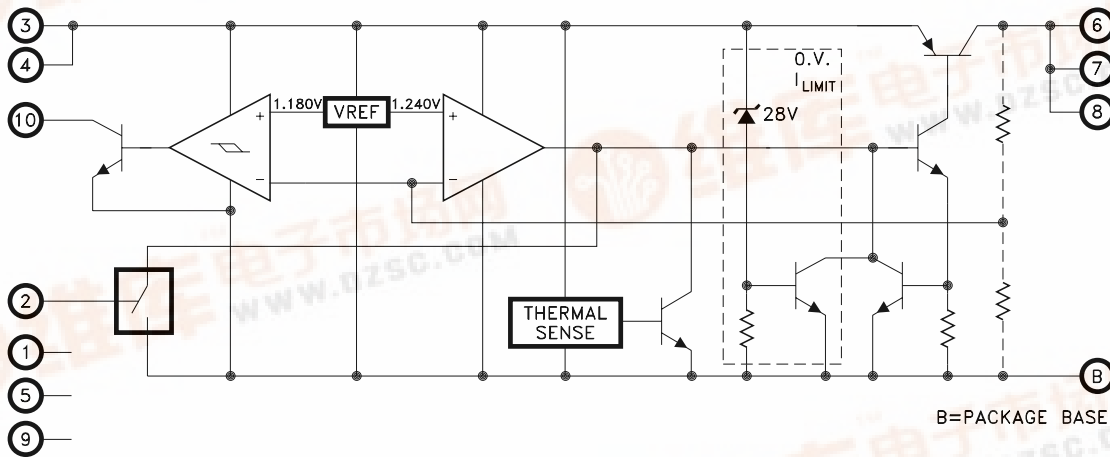

Schematic shown for fixed output voltage versions

TYPICAL APPLICATIONS

- High Efficiency, High Current Linear Regulators
- Constant Voltage/Current Regulators
- System Power Supplies
- Switching Power Supply Post Regulators
- Battery Powered Equipment

PIN-OUT INFORMATION

MSK5101-00	MSK5101-3.3,-5.0,-12
1 NC	1 NC
2 Enable	2 Enable
3 Vin A	3 Vin A
4 Vin B	4 Vin B
5 NC	5 NC
6 Vout A	6 Vout A
7 Vout B	7 Vout B
8 NC	8 Vout C
9 Adj	9 NC
10 NC	10 Flag

BASE

The base of the package is electrically connected to ground



ABSOLUTE MAXIMUM RATINGS ^⑩

V_{INP} Input Voltage (100ms 1%D.C.) -20V to +60V
 V_{IN} Input Voltage 26V
 V_{EN} Enable Voltage -0.3V to 26V
 I_{OUT} Output Current 3.5A

T_{ST} Storage Temperature Range -65°C to +150°C
 T_{LD} Lead Temperature 300°C
 (10 Seconds Soldering)
 T_J Operating Temperature
 MSK5101 Series -40°C to +85°C
 MSK5101H/E Series -55°C to +125°C

ELECTRICAL SPECIFICATIONS

Parameter	Test Conditions ^{①③}	Group A	MSK 5101H/E SERIES			MSK 5101 SERIES			Units
		Subgroup	Min.	Typ.	Max.	Min.	Typ.	Max.	
Output Voltage Tolerance ^⑧	$I_{OUT} = 10mA$; $V_{IN} = V_{OUT} + 1V$	1	-	±0.5	±1.0	-	±0.5	±1.0	%
		2,3	-	±1.0	±2.0	-	-	-	%
Dropout Voltage ^②	$\Delta V_{OUT} = -1\%$; $I_{OUT} = 100mA$	1	-	80	200	-	80	225	mV
	$\Delta V_{OUT} = -1\%$; $I_{OUT} = 1.5A$	1	-	350	600	-	350	625	mV
Load Regulation ^⑨	$V_{IN} = V_{OUT} + 1V$ $10mA \leq I_{OUT} \leq 1.25A$	1	-	±0.2	±1.0	-	±0.2	±1.2	%
		2,3	-	±0.3	±2.0	-	±0.3	-	%
Line Regulation	$(V_{OUT} + 1V) \leq V_{IN} \leq 26V$ $I_{OUT} = 10mA$	1	-	±0.05	±0.5	-	±0.05	±0.6	%
		2,3	-	±0.5	±1.0	-	±0.5	-	%
Output Current Limit ^②	$V_{OUT} = 0V$; $V_{IN} = V_{OUT} + 1V$	-	-	2.1	3.5	-	2.1	3.5	A
Ground Current ^②	$V_{IN} = V_{OUT} + 1V$; $I_{OUT} = 0.75A$	-	-	8	20	-	8	20	mA
	$V_{IN} = V_{OUT} + 1V$; $I_{OUT} = 1.5A$	-	-	22	-	-	22	-	mA
Output Noise ^②	$C_L = 10\mu F$; $10Hz \leq f \leq 100KHz$	-	-	400	-	-	400	-	μV
Enable Input Voltage ^②	HIGH/ON	1	2.4	-	-	2.4	-	-	V
	LOW/OFF	1	-	-	0.8	-	-	0.8	V
Enable Input Current ^②	HIGH/ON	1	-	100	600	-	100	600	μA
	LOW/OFF	1	-	-	2	-	-	2	μA
Shutdown Output Current ^②	$V_{ENABLE} \leq 0.8V$	-	-	10	500	-	10	500	μA
Flag Output Leakage ^{②⑧}	$V_{OH} = 26V$	-	-	0.01	2	-	0.01	2	μA
Flag Output On Voltage ^⑧	$I_{OL} \leq 250\mu A$; $V_{IN} = V_{OUT} - 2V$	1	-	0.2	0.4	-	0.2	0.4	V
Flag Threshold ^{②⑧}	$V_{IN} = V_{OUT} - 7\%$	-	-	75	-	-	75	-	mV
Reference Voltage ^⑦	Normal Operation	1	1.22	1.24	1.26	1.22	1.24	1.26	V
Reference Voltage Temp Drift ^{②⑦}	Normal Operation	-	-	20	-	-	20	-	ppm/°C
Adjust Pin Bias Current ^{②⑦}	Full Temp; $V_{IN} = V_{OUT} + 1V$	-	-	40	120	-	40	150	nA
Thermal Resistance ^②	Junction to Case @ 125°C	-	-	5.6	6.0	-	5.6	7	°C/W
Thermal Shutdown	T_J	-	-	135	-	-	135	-	°C

NOTES:

- ① Output decoupled to ground using 10 μF minimum capacitor unless otherwise specified.
- ② This parameter is guaranteed by design but need not be tested.
- ③ Typical parameters are representative of actual device performance but are for reference only.
- ④ All output parameters are tested using a low duty cycle pulse to maintain $T_J = T_C$.
- ⑤ Industrial grade and class E devices shall be tested to subgroups 1 and 4 unless otherwise specified.
- ⑥ Military grade devices ('H' suffix) shall be 100% tested to subgroups 1,2,3 and 4.
- ⑦ Subgroup 1,4 $T_C = +25^\circ C$
Subgroup 2 $T_J = +125^\circ C$
Subgroup 3 $T_A = -55^\circ C$
- ⑦ Applies to MSK5101-00 adjustable version only.
- ⑧ Applies to fixed output devices only.
- ⑨ Due to current limit, maximum output current may not be available at all values of V_{IN} - V_{OUT} and temperatures. See typical performance curves for clarification.
- ⑩ Continuous operation at or above absolute maximum ratings may adversely effect the device performance and/or life cycle.

PART NUMBER	OUTPUT VOLTAGE
MSK5101-00	Adjustable
MSK5101-3.3	+3.3V
MSK5101-5.0	+5.0V
MSK5101-12	+12.0V

APPLICATION NOTES

REGULATOR PROTECTION:

The MSK 5101 series is fully protected against reversed input polarity, overcurrent faults, overtemperature conditions (Pd) and transient voltage spikes of up to 60V. If the regulator is used in dual supply systems where the load is returned to a negative supply, the output voltage must be diode clamped to ground.

OUTPUT CAPACITOR:

The output voltage ripple of the MSK 5101 series voltage regulators can be minimized by placing a filter capacitor from the output to ground. The optimum value for this capacitor may vary from one application to the next, but a minimum of 10 μ F is recommended for optimum performance. Transient load response can also be improved by placing a capacitor directly across the load.

LOAD CONNECTIONS:

In voltage regulator applications where very large load currents are present, the load connection is very important. The path connecting the output of the regulator to the load must be extremely low impedance to avoid affecting the load regulation specifications. Any impedance in this path will form a voltage divider with the load. The MSK 5101 series requires a minimum of 10mA of load current to stay in regulation.

ENABLE PIN:

The MSK 5101 series of voltage regulators are equipped with a TTL compatible ENABLE pin. A TTL high level on this pin activates the internal bias circuit and powers up the device. A TTL low level on this pin places the controller in shutdown mode and the device draws approximately 10 μ A of quiescent current. If the enable function is not used, simply connect the enable pin to the input.

FLAG OUTPUT PIN:

All of the fixed output voltage versions of the MSK 5101 series are equipped with a flag output pin. Since the flag pin is an open collector configuration it can be pulled up to any voltage between 3V and 26V. This feature allows direct interfacing to practically any logic. This active low output has a typical level of 0.22V when the flag comparator detects an "out of regulation" condition. Flag states include low input voltage and output current limit. Extremely high level input voltage transients will also cause the flag output pin to activate.

MSK5101-00 OUTPUT ADJUSTMENT:

The MSK 5101-00 is an adjustable version in the series of high performance regulators. The diagram below illustrates proper adjustment technique for the output voltage. The series resistance of R1 + R2 should be selected to pass the minimum regulator output current requirement of 10mA.

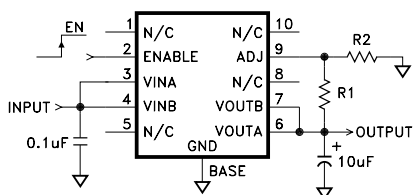

$$V_{OUT} = 1.240V \times [1 + (R1/R2)]$$

HEAT SINK SELECTION:

To select a heat sink for the MSK 5100, the following formula for convective heat flow may be used.

Governing Equation:

$$T_j = P_d \times (R_{\theta jc} + R_{\theta cs} + R_{\theta sa}) + T_a$$

WHERE:

T_j = Junction Temperature

P_d = Total Power Dissipation

$R_{\theta jc}$ = Junction to Case Thermal Resistance

$R_{\theta cs}$ = Case to Heat Sink Thermal Resistance

$R_{\theta sa}$ = Heat Sink to Ambient Thermal Resistance

T_a = Ambient Temperature

First, the power dissipation must be calculated as follows:

$$\text{Power Dissipation} = (V_{in} - V_{out}) \times I_{out}$$

Next, the user must select a maximum junction temperature. The maximum allowable junction temperature is 125°C. The equation may now be rearranged to solve for the required heat sink to ambient thermal resistance ($R_{\theta sa}$).

EXAMPLE:

An MSK 5101-3.3 is configured for $V_{in} = +5V$ and $V_{out} = +3.3V$. I_{out} is a continuous 1A DC level. The ambient temperature is +25°C. The maximum desired junction temperature is 125°C.

$R_{\theta jc} = 6^\circ\text{C/W}$ and $R_{\theta cs} = 0.5^\circ\text{C/W}$ typically.

$$\begin{aligned} \text{Power Dissipation} &= (5V - 3.3V) \times (1A) \\ &= 1.7 \text{ Watts} \end{aligned}$$

Solve for $R_{\theta sa}$:

$$\begin{aligned} R_{\theta sa} &= \left[\frac{125^\circ\text{C} - 25^\circ\text{C}}{1.7\text{W}} \right] - 6^\circ\text{C/W} - 0.5^\circ\text{C/W} \\ &= 52.3^\circ\text{C/W} \end{aligned}$$

In this example, a heat sink with a thermal resistance of no more than 52°C/W must be used to maintain a junction temperature of no more than 125°C.

DEVICE SOLDERING/CASE CONNECTION:

The MSK 5101 series are highly thermally conductive devices and the thermal path from the package base to the internal junctions is very short. Standard surface mount techniques should be used when soldering the device into a circuit board. The external heat sink/pad needs to be connected to ground because the base of the MSK 5101 is also electrically connected to ground. The user is urged to keep this in mind when designing the printed circuit board for the MSK 5101. There should be no printed circuit traces making contact with the base of the device except for ground. The ground plane can be used to pull heat away from the device.

TYPICAL PERFORMANCE CURVES

DROPOUT vs OUTPUT CURRENT

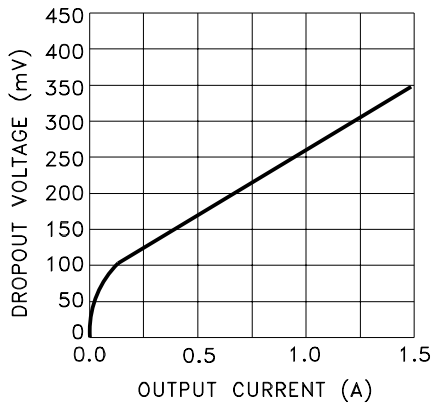

DROPOUT vs TEMPERATURE

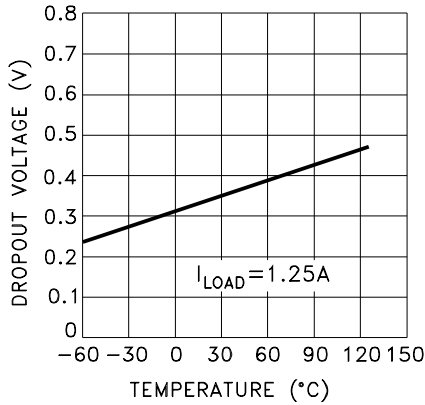

GROUND CURRENT vs. OUTPUT CURRENT

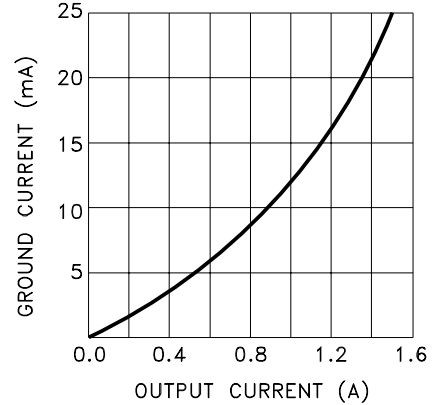

GROUND CURRENT vs. TEMPERATURE

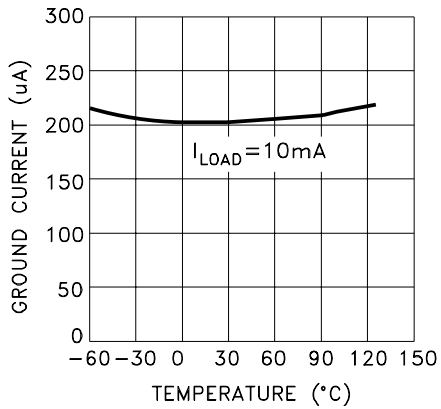

SHORT CIRCUIT CURRENT vs. TEMP.

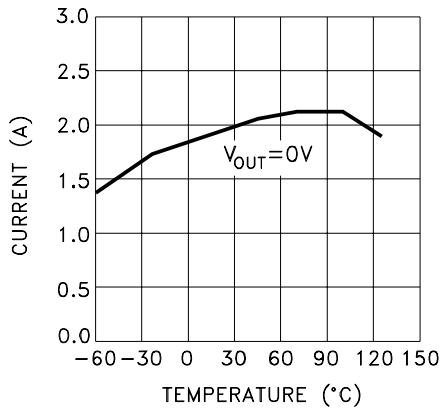

ENABLE CURRENT vs. TEMPERATURE

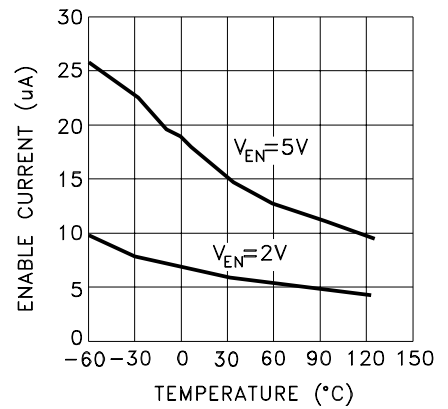

LOAD TRANSIENT RESPONSE

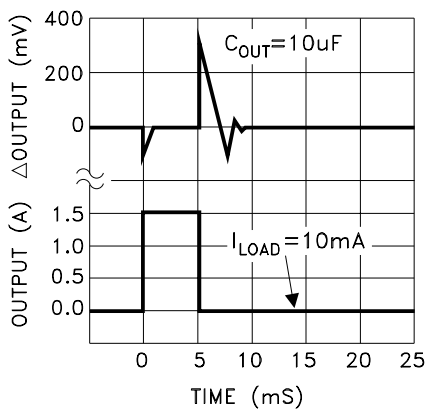

ADJUST PIN CURRENT vs. TEMP.

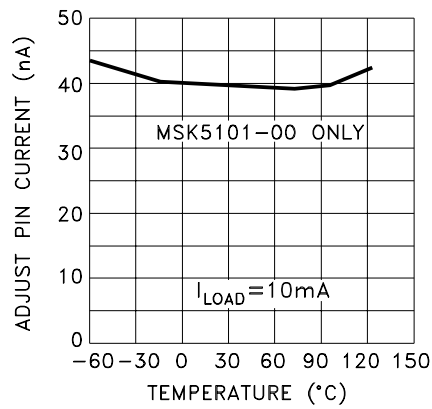

LINE TRANSIENT RESPONSE

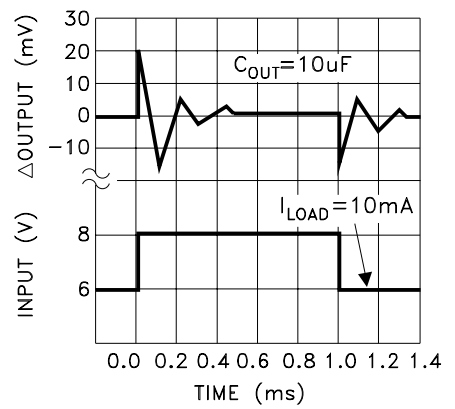

OUTPUT IMPEDANCE vs. FREQUENCY

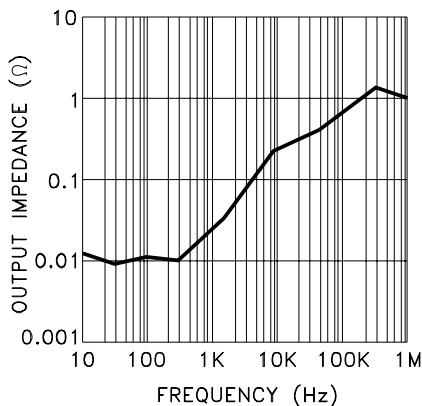

MECHANICAL SPECIFICATIONS

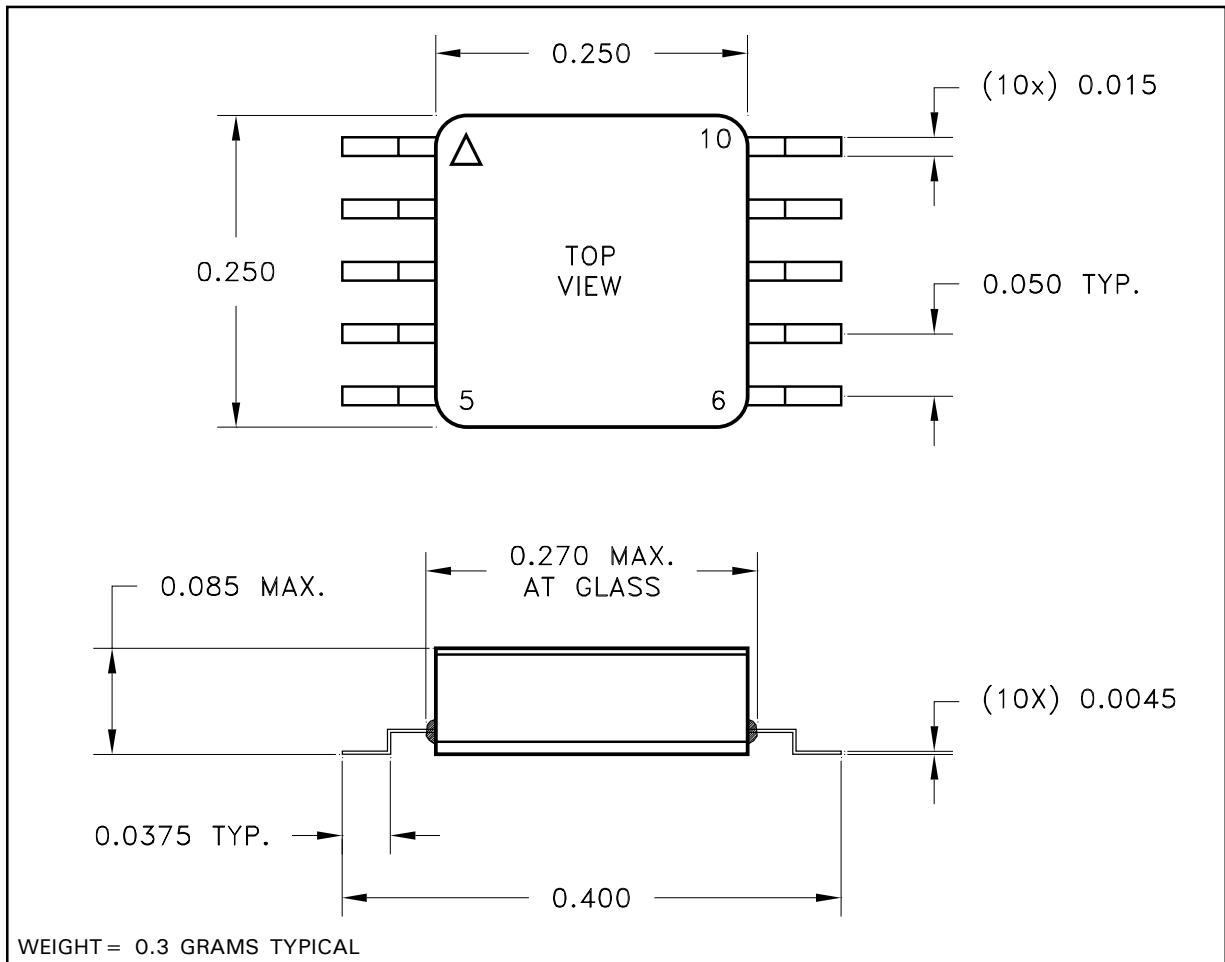

NOTE: ALL DIMENSIONS ARE ± 0.010 INCHES UNLESS OTHERWISE LABELED.
ESD Triangle indicates Pin 1.

ORDERING INFORMATION

MSK5101-3.3 H

SCREENING

BLANK = INDUSTRIAL, E = EXTENDED RELIABILITY;

H = MIL-PRF-38534 CLASS H

OUTPUT VOLTAGE

00 = Adjustable; 3.3 = + 3.3V; 5.0 = + 5.0V; 12 = + 12.0V

GENERAL PART NUMBER

The above example is a + 3.3V, Military regulator.

M.S. Kennedy Corp.

4707 Dey Road, Liverpool, New York 13088

Phone (315) 701-6751

FAX (315) 701-6752

www.mskennedy.com

The information contained herein is believed to be accurate at the time of printing. MSK reserves the right to make changes to its products or specifications without notice, however, and assumes no liability for the use of its products.

Please visit our website for the most recent revision of this datasheet.

Contact MSK for MIL-PRF-38534 qualification status.