



FMS2016-001

High Power Reflective GaAs SP4T Switch

Datasheet v2.4

FEATURES:

- 3x3x0.9mm Packaged pHEMT Switch
- High isolation: >30dB at 1.8GHz
- Low Insertion loss: 0.65dB at 1.8GHz
- Excellent low control voltage performance
- Excellent harmonic performance under GSM/DCS/PCS/EDGE power levels
- RoHS Compliant (Directive 2002/95/EC)

GENERAL DESCRIPTION:

The FMS2016-001 is a low loss, high power and linear single pole four throw Gallium Arsenide antenna switch designed for use in mobile handset and other high power switching applications. The die is fabricated using the Filtronic FL05 0.5 μ m switch process technology, which offers excellent performance optimised for switch applications.

FUNCTIONAL SCHEMATIC:

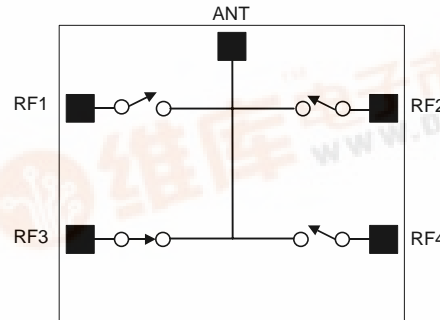

TYPICAL APPLICATIONS:

- Multi-band GSM/DCS/PCS/EDGE handset modules
- High power and linear RF switching applications

ELECTRICAL SPECIFICATIONS:

Parameter	Test Conditions	Min	Typ	Max	Units
Insertion Loss	0.5 – 1.0 GHz		0.55	0.75	dB
	1.0 – 2.0 GHz		0.65	0.85	dB
Return Loss	0.5 – 2.5 GHz	16	20		dB
Isolation RF1 – RF2, RF1 – RF3, RF2 – RF4	0.5 – 1.0 GHz		34		dB
	1.0 – 2.0 GHz	30	32		dB
Isolation RF3 – RF4	0.5 – 1.0 GHz		34		dB
	1.0 – 2.0 GHz	26	30		dB
2nd Harmonic Level	1 GHz, Pin = +35 dBm, 100% Duty Cycle		-75	-60	dBc
	2 GHz, Pin = +35 dBm, 100% Duty Cycle		-75	-65	dBc
3rd Harmonic Level	1 GHz, Pin = +35 dBm, 100% Duty Cycle		-75	-60	dBc
	2 GHz, Pin = +35 dBm, 100% Duty Cycle		-75	-65	dBc
Switching speed : Trise, Tfall Ton, Toff	10% to 90% RF and 90% to 10% RF		<0.3		μ s
	50% control to 90% RF and 50% control to 10% RF			0.5	μ s
Control Current	+35dBm RF input @1GHz		<10	15	μ A
IP3	0.9 & 0.91 GHz, Pin = +20 dBm		>68		dBm
	1.85 & 1.86 GHz, Pin = +20 dBm		>66		dBm
P0.1dB	1.0GHz		>38		dBm
	2.0GHz		>37		dBm

Note: T_{AMBIENT} = 25°C, V_{ctrl} = 0V/2.7V, Z_{IN} = Z_{OUT} = 50 Ω
External DC blocking capacitors are required on all RF ports (typ: 47pF)



ABSOLUTE MAXIMUM RATINGS:

PARAMETER	SYMBOL	ABSOLUTE MAXIMUM
Max Input Power	Pin	+38dBm
Control Voltage	Vctrl	+6V
Operating Temperature	Toper	-40°C to +100°C
Storage Temperature	Tstor	-55°C to +150°C

Note: Exceeding any one of these absolute maximum ratings may cause permanent damage to the device.

TRUTH TABLE:

V1	V2	V3	V4	PATH(S)
High	Low	Low	Low	RF1 to ANT
Low	High	Low	Low	RF2 to ANT
Low	Low	High	Low	RF3 to ANT
Low	Low	Low	High	RF4 to ANT

Note: High: 2.7V to 6V; Low: 0V to 0.2V

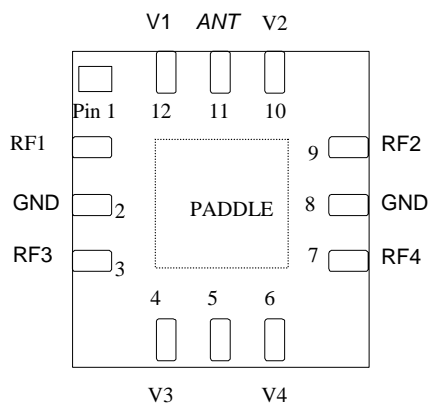
PAD LAYOUT:

PAD REF	PAD NAME	DESCRIPTION
1	RF1	RF Port 1
2	GND	Ground Connection
3	RF3	RF Port 3
4	V3	Vctrl3 (ANT to RF3)
5	N/C	No Connection
6	V4	Vctrl4 (ANT to RF4)
7	RF4	RF Port 4
8	GND	Ground Connection
9	RF2	RF Port 2
10	V2	Vctrl2 (ANT to RF2)
11	ANT	Antenna Port
12	V1	Vctrl1 (ANT to RF1)

TYPICAL MEASURED PERFORMANCE ON EVALUATION BOARD:

 Note: Measurement Conditions $V_{CTRL} = 0V$ (low) & $2.5V$ (high), $T_{AMBIENT} = 25^{\circ}C$ unless otherwise stated

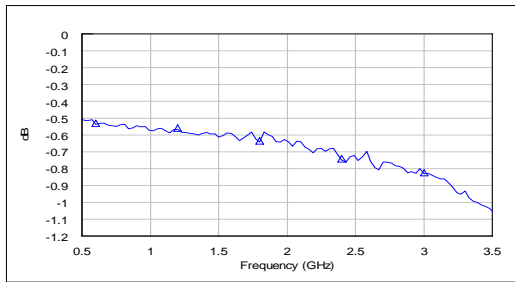
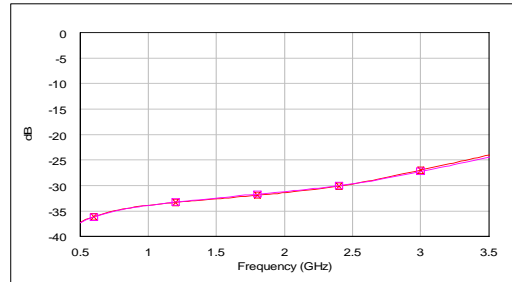
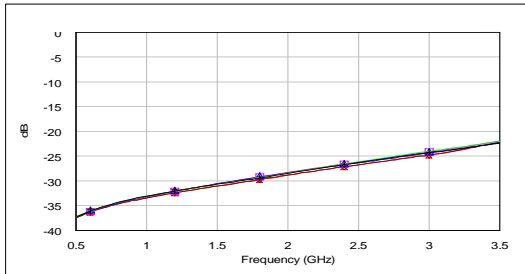
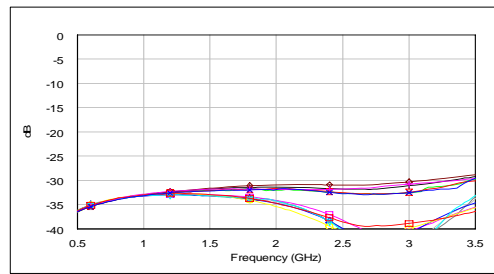
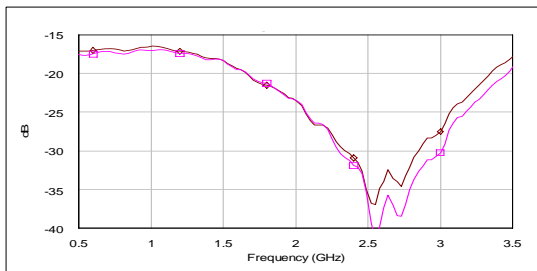
Insertion Loss

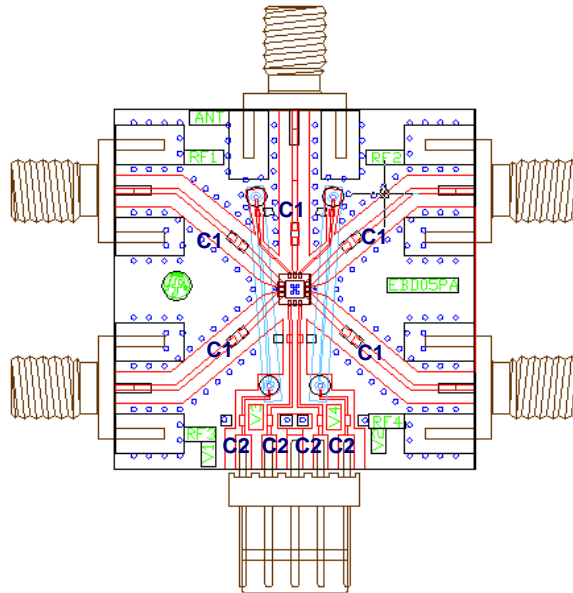
RF1 to RF2 Isolation

RF3 to RF4 Isolation

RF1 to RF3 AND RF2 to RF4 Isolation

Return Loss

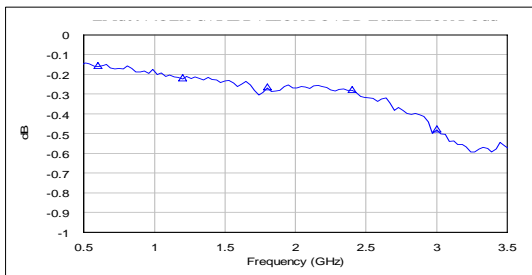
EVALUATION BOARD COMPONENT SIDE LAYOUT:

BILL OF MATERIALS:

LABEL	COMPONENT
Board	Preferred evaluation board material is 0.25 mm thick ROGERS RT4350. All RF tracks should be 50 ohm characteristic material.
RFC	SMA RF connector
DCC	DC connector
C1	Capacitor, 47pF, 0402
C2	Capacitor, 470pF, 0603

EVALUATION BOARD DE-EMBEDDING DATA (MEASURED):

Insertion Loss



Return Loss

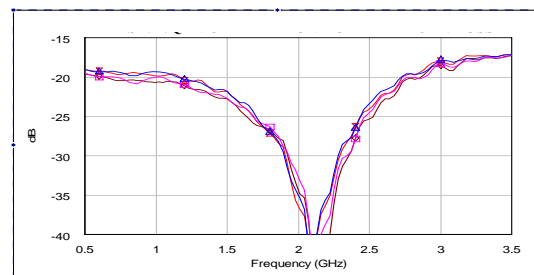

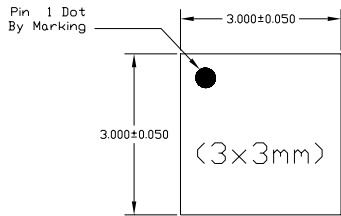
QFN 12 LEAD 3*3 PACKAGE OUTLINE:

TOP VIEW

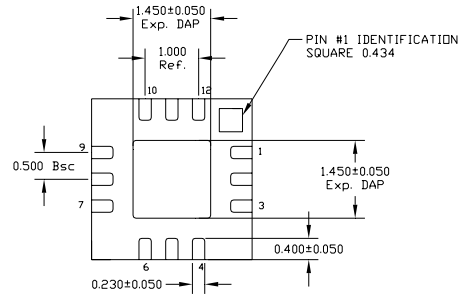

Note: PIN1 Identifier is at ground potential

BOTTOM VIEW

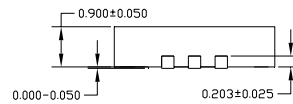

SIDE VIEW

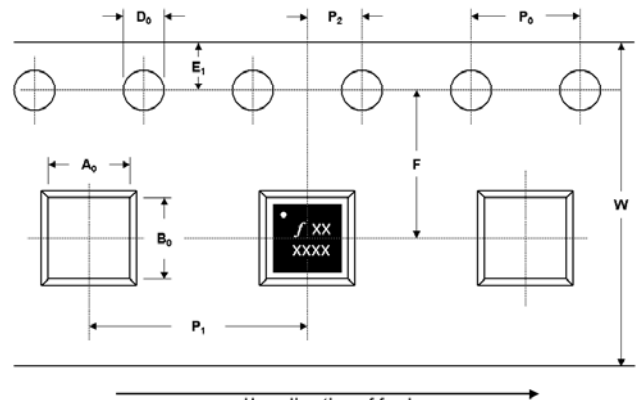
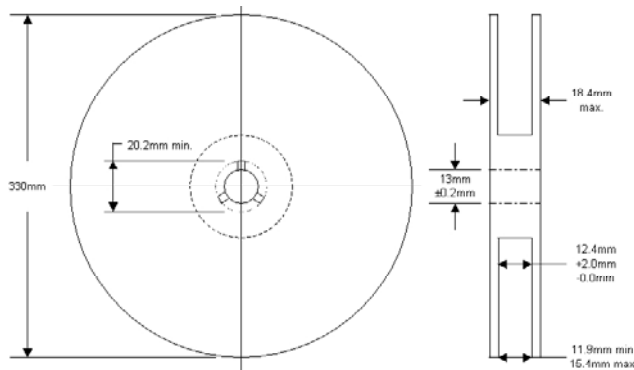
TAPE & REEL SPECIFICATION:

TAPE DIMENSIONS	DESCRIPTION	SYMBOL	SIZE (MM)
Perforation	Diameter	D0	1.5 ±0.1
	Pitch	P0	4.0 ±0.1
	Position	E1	1.75 ±0.1
Cavity	Length	A0	3.3 ±0.1
	Width	B0	3.3 ±0.1
	Depth	K	1.1 ±0.1
Distance between centrelines	Cavity to Perforation (length direction)	P2	2.0 ±0.1
	Cavity to Perforation (width direction)	F	5.5 ±0.1
Carrier tape	Width	W	12 ±0.3

PREFERRED ASSEMBLY INSTRUCTIONS:

Please refer to the FCSL Document on our website, under Handling and Assembly instructions, named; 'QFN and DFN series package Assembly Guidelines'

HANDLING PRECAUTIONS:

To avoid damage to the devices care should be exercised during handling. Proper Electrostatic Discharge (ESD) precautions should be observed at all stages of storage, handling, assembly, and testing. These devices should be treated as Class 1A (0-500 V) as defined in JEDEC Standard No. 22-A114. Further information on ESD control measures can be found in MIL-STD-1686 and MIL-HDBK-263.

APPLICATION NOTES & DESIGN DATA:

Application Notes and design data, including S-parameters are available on request.

DISCLAIMERS:

This product is not designed for use in any space based or life sustaining/supporting equipment.

ORDERING INFORMATION:

PART NUMBER	DESCRIPTION
FMS2016-001-TR	Packaged Die Tape & Reel (minimum quantity: 1k pcs)
FMS2016-001-TB	Packaged Die supplied in a Tube
FMS2016-001-EB	Packaged Die mounted on Evaluation Board