

February 2006



FFA40UP20DN

Ultrafast Recovery Power Rectifier

Features

- Ultrafast with Soft Recovery : < 45ns (@ $I_F = 20A$)
- High Reverse Voltage : $V_{RRM} = 200V$
- Avalanche Energy Rated
- Planar Construction

Applications

- Output Rectifiers
- Switching Mode Power Supply
- Free-wheeling diode for motor application
- Power switching circuits

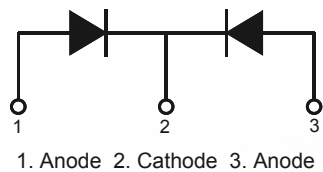

Absolute Maximum Ratings

(per diode) $T_C = 25^\circ C$ unless otherwise noted

Symbol	Parameter	Value	Units
V_{RRM}	Peak Repetitive Reverse Voltage	200	V
V_{RWM}	Working Peak Reverse Voltage	200	V
V_R	DC Blocking Voltage	200	V
$I_{F(AV)}$	Average Rectified Forward Current @ $T_C = 120^\circ C$	20	A
I_{FSM}	Non-repetitive Peak Surge Current 60Hz Single Half-Sine Wave	200	A
T_J, T_{STG}	Operating Junction and Storage Temperature	- 65 to +150	$^\circ C$

Thermal Characteristics

Symbol	Parameter	Max	Units
$R_{\theta JC}$	Maximum Thermal Resistance, Junction to Case	1.9	$^\circ C/W$

Package Marking and Ordering Information

Device Marking	Device	Package	Reel Size	Tape Width	Quantity
F40UP20DN	FFA40UP20DNTU	TO-3P	-	-	30

FFA40UP20DN Ultrafast Recovery Power Rectifier



Electrical Characteristics (per diode) $T_C = 25^\circ\text{C}$ unless otherwise noted

Symbol	Parameter	Min.	Typ.	Max.	Units	
V_{FM}^*	$I_F = 20\text{A}$ $I_F = 20\text{A}$	$T_C = 25^\circ\text{C}$	-	-	1.15	V
		$T_C = 100^\circ\text{C}$	-	-	1.0	V
I_{RM}^*	$V_R = 200\text{V}$ $V_R = 200\text{V}$	$T_C = 25^\circ\text{C}$	-	-	100	μA
		$T_C = 100^\circ\text{C}$	-	-	500	μA
t_{rr}	$I_F = 1\text{A}, di/dt = 100\text{A}/\mu\text{s}, V_{CC} = 30\text{V}$ $I_F = 20\text{A}, di/dt = 200\text{A}/\mu\text{s}, V_{CC} = 130\text{V}$	$T_C = 25^\circ\text{C}$	-	-	35	ns
		$T_C = 25^\circ\text{C}$	-	-	45	ns
t_a t_b Q_{rr}	$I_F = 20\text{A}, di/dt = 200\text{A}/\mu\text{s}, V_{CC} = 130\text{V}$	$T_C = 25^\circ\text{C}$	-	11	-	ns
		$T_C = 25^\circ\text{C}$	-	13	-	ns
		$T_C = 25^\circ\text{C}$	-	21	-	nC
W_{AVL}	Avalanche Energy (L = 40mH)	20	-	-	mJ	

* Pulse Test: Pulse Width=300 μs , Duty Cycle=2%

Test Circuit and Waveforms

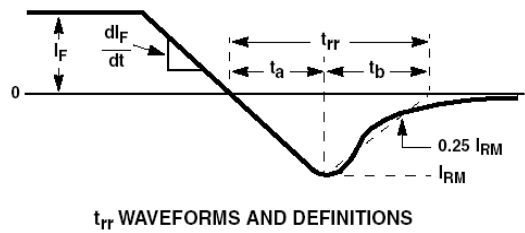
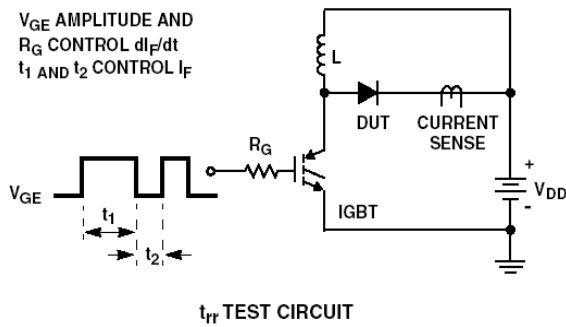

$I_{MAX} = 1\text{A}$
 $L = 40\text{mH}$
 $R < 0.1\Omega$
 $E_{AVL} = 1/2LI^2 [V_{R(AVL)}/(V_{R(AVL)} - V_{DD})]$
 $Q_1 = \text{IGBT (}BV_{CES} > \text{DUT } V_{R(AVL)})$

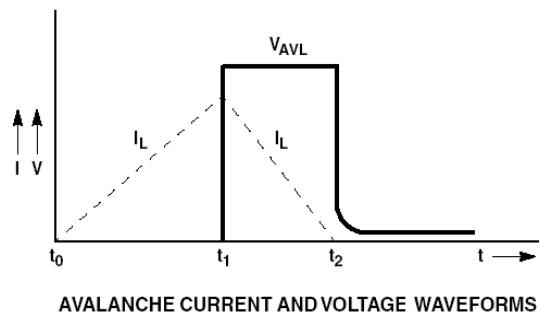
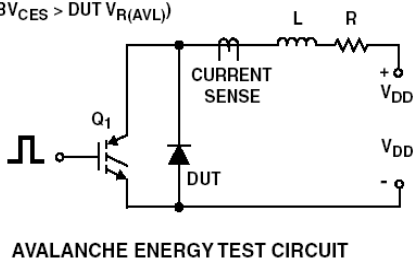

Typical Performance Characteristics

Figure 1. Typical Forward Voltage Drop

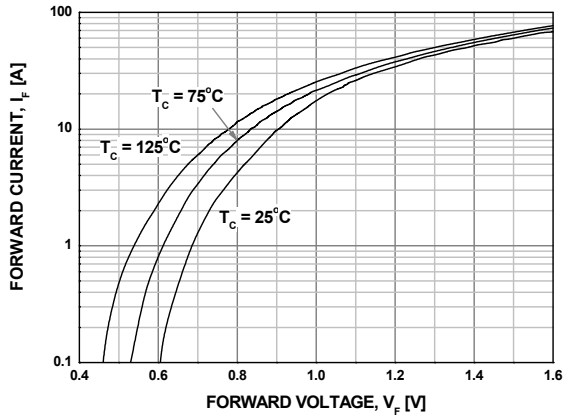

Figure 2. Typical Reverse Current

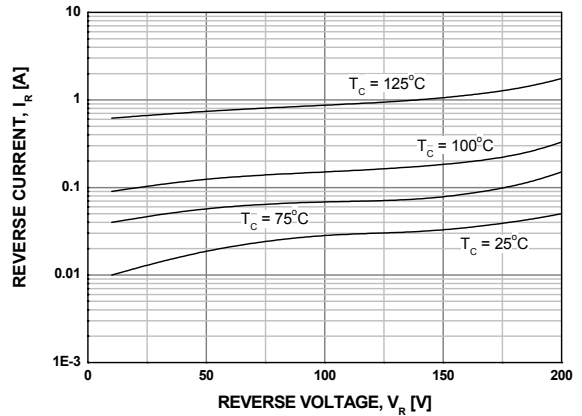

Figure 3. Typical Junction Capacitance

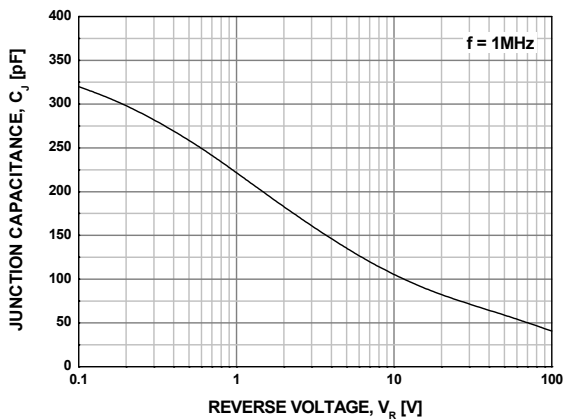

Figure 4. Typical Reverse Recovery Time

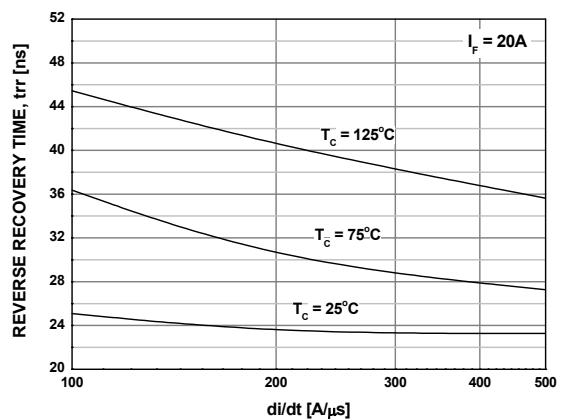

Figure 5. Typical Reverse Recovery Current

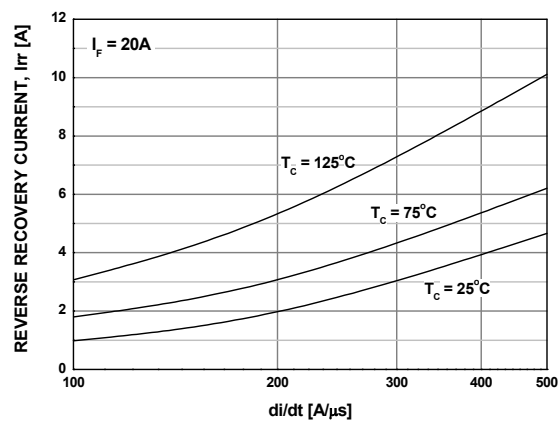
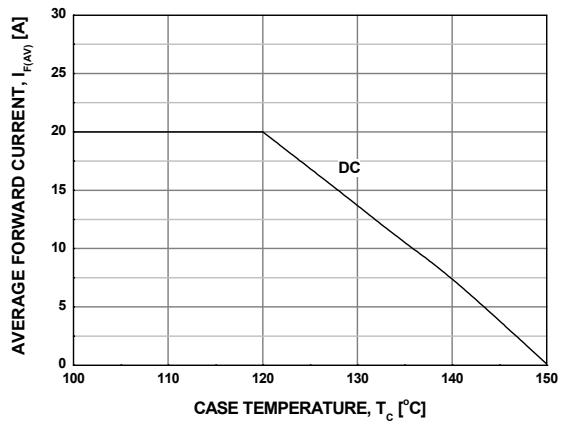
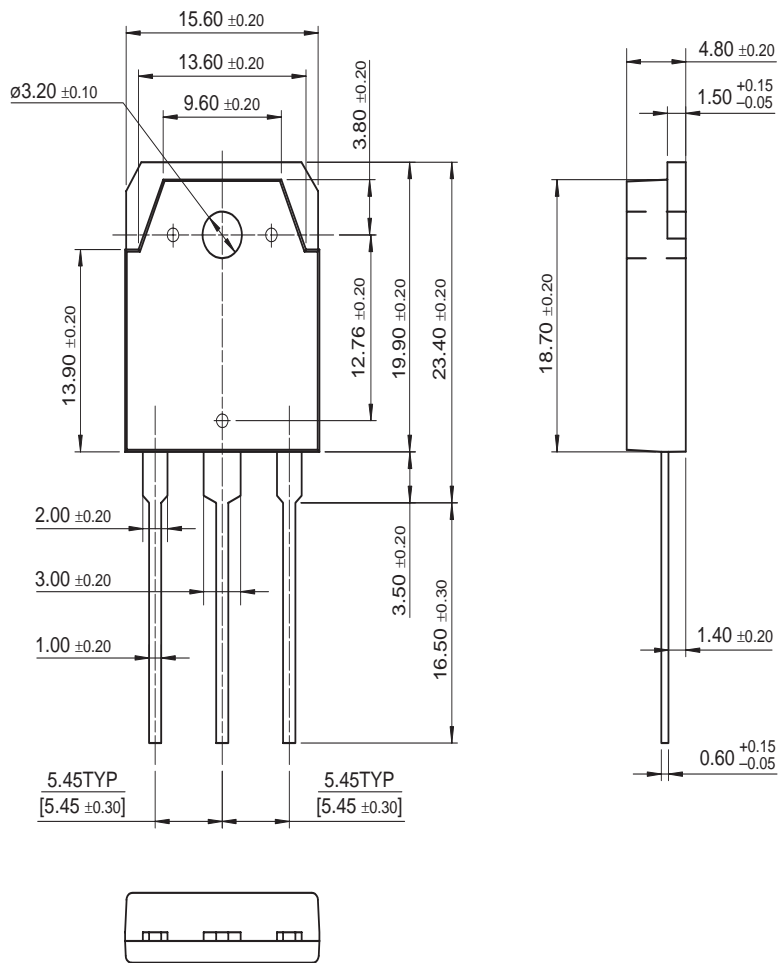

Figure 6. Forward Current Deration Curve



Package Dimensions

TO-3P



Dimensions in Millimeters

TRADEMARKS

The following are registered and unregistered trademarks Fairchild Semiconductor owns or is authorized to use and is not intended to be an exhaustive list of all such trademarks.

ACEx™	FAST®	ISOPLANAR™	PowerSaver™	SuperSOT™-6
ActiveArray™	FASTr™	LittleFET™	PowerTrench®	SuperSOT™-8
Bottomless™	FPS™	MICROCOUPLER™	QFET®	SyncFET™
Build it Now™	FRFET™	MicroFET™	QS™	TCM™
CoolFET™	GlobalOptoisolator™	MicroPak™	QT Optoelectronics™	TinyLogic®
CROSSVOLT™	GTO™	MICROWIRE™	Quiet Series™	TINYOPTO™
DOVE™	HiSeC™	MSX™	RapidConfigure™	TruTranslation™
EcoSPARK™	I ² C™	MSXPro™	RapidConnect™	UHC™
E ² CMOS™	i-Lo™	OCX™	μSerDes™	UltraFET®
EnSigna™	ImpliedDisconnect™	OCXPro™	Scalar Pump™	UniFET™
FACT™	IntelliMAX™	OPTOLOGIC®	SILENT SWITCHER®	VCX™
FACT Quiet Series™		OPTOPLANAR™	SMART START™	Wire™
Across the board. Around the world.™		PACMAN™	SPM™	
The Power Franchise®		POP™	Stealth™	
Programmable Active Droop™		Power247™	SuperFET™	
		PowerEdge™	SuperSOT™-3	

DISCLAIMER

FAIRCHILD SEMICONDUCTOR RESERVES THE RIGHT TO MAKE CHANGES WITHOUT FURTHER NOTICE TO ANY PRODUCTS HEREIN TO IMPROVE RELIABILITY, FUNCTION OR DESIGN. FAIRCHILD DOES NOT ASSUME ANY LIABILITY ARISING OUT OF THE APPLICATION OR USE OF ANY PRODUCT OR CIRCUIT DESCRIBED HEREIN; NEITHER DOES IT CONVEY ANY LICENSE UNDER ITS PATENT RIGHTS, NOR THE RIGHTS OF OTHERS.

LIFE SUPPORT POLICY

FAIRCHILD'S PRODUCTS ARE NOT AUTHORIZED FOR USE AS CRITICAL COMPONENTS IN LIFE SUPPORT DEVICES OR SYSTEMS WITHOUT THE EXPRESS WRITTEN APPROVAL OF FAIRCHILD SEMICONDUCTOR CORPORATION.

As used herein:

1. Life support devices or systems are devices or systems which, (a) are intended for surgical implant into the body, or (b) support or sustain life, or (c) whose failure to perform when properly used in accordance with instructions for use provided in the labeling, can be reasonably expected to result in significant injury to the user.
2. A critical component is any component of a life support device or system whose failure to perform can be reasonably expected to cause the failure of the life support device or system, or to affect its safety or effectiveness.

PRODUCT STATUS DEFINITIONS

Definition of Terms

Datasheet Identification	Product Status	Definition
Advance Information	Formative or In Design	This datasheet contains the design specifications for product development. Specifications may change in any manner without notice.
Preliminary	First Production	This datasheet contains preliminary data, and supplementary data will be published at a later date. Fairchild Semiconductor reserves the right to make changes at any time without notice in order to improve design.
No Identification Needed	Full Production	This datasheet contains final specifications. Fairchild Semiconductor reserves the right to make changes at any time without notice in order to improve design.
Obsolete	Not In Production	This datasheet contains specifications on a product that has been discontinued by Fairchild semiconductor. The datasheet is printed for reference information only.