



NEC's NPN SILICON HIGH FREQUENCY TRANSISTOR

NE696M01

FEATURES

- **HIGH f_T :**
14 GHz TYP at 3 V, 10 mA
- **LOW NOISE FIGURE:**
NF = 1.6 dB TYP at 2 GHz
- **HIGH GAIN:**
 $IS_{21EI}^2 = 14$ dB TYP at 2 GHz
- **6 PIN SMALL MINI MOLD PACKAGE**
- **EXCELLENT LOW VOLTAGE, LOW CURRENT PERFORMANCE**

DESCRIPTION

NEC's NE696M01 is an NPN high frequency silicon epitaxial transistor (NE685) encapsulated in an ultra small 6 pin SOT-363 package. Its four emitter pins decrease emitter inductance resulting in 3 dB more gain compared to conventional SOT-23 and SOT-143 devices. The NE696M01 is ideal for LNA and pre-driver applications up to 2.4 GHz where low cost, high gain, low voltage and low current are prime considerations.

OUTLINE DIMENSIONS (Units in mm)

PACKAGE OUTLINE M01

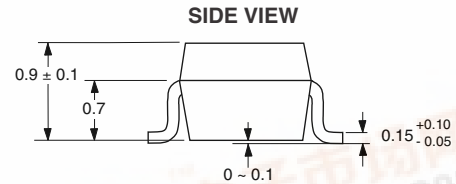
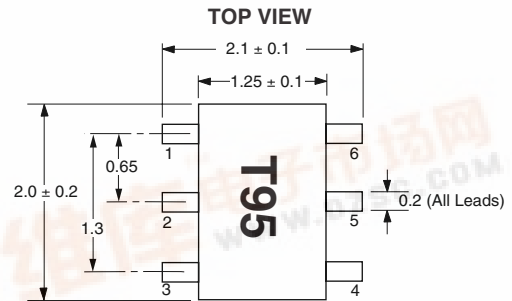

PIN OUT

- 1. Emitter 4. Emitter
- 2. Emitter 5. Emitter
- 3. Base 6. Collector

Note:

Pin 3 is identified with a circle on the bottom of the package.

ELECTRICAL CHARACTERISTICS (TA = 25°C)

PART NUMBER PACKAGE OUTLINE			NE696M01 M01		
SYMBOLS	PARAMETERS AND CONDITIONS	UNITS	MIN	TYP	MAX
IcBO	Collector Cutoff Current at VCB = 5 V, IE = 0	μA			0.1
IEBO	Emitter Cutoff Current at VEB = 1 V, IC = 0	μA			0.1
hFE ¹	Forward Current Gain at VCE = 3 V, IC = 10 mA		80	120	160
fT	Gain Bandwidth at VCE = 3 V, IC = 10 mA, f = 2 GHz	GHz		14	
Cre ²	Feedback Capacitance at VCB = 3 V, IE = 0, f = 1 MHz	pF		0.15	
IS _{21EI} ²	Insertion Power Gain at VCE = 3 V, IC = 10 mA, f = 2 GHz	dB		14	
NF	Noise Figure at VCE = 3 V, IC = 3 mA, f = 2 GHz	dB		1.6	

Notes:

1. Pulsed measurement, pulse width ≤ 350 μs, duty cycle ≤ 2%.
2. The emitter terminal should be connected to the ground terminal of the 3 terminal capacitance bridge.
3. For Tape and Reel version use part number NE696M01-T1, 3K per reel.



NE696M01

ABSOLUTE MAXIMUM RATINGS¹ (T_A = 25°C)

SYMBOLS	PARAMETERS	UNITS	RATINGS
V _{CBO}	Collector to Base Voltage	V	9
V _{CEO}	Collector to Emitter Voltage	V	6
V _{EBO}	Emitter to Base Voltage	V	2
I _C	Collector Current	mA	30
P _T	Total Power Dissipation	mW	150
T _J	Junction Temperature	°C	150
T _{STG}	Storage Temperature	°C	-65 to +150

Notes:

1. Operation in excess of any one of these parameters may result in permanent damage.

ORDERING INFORMATION

PART NUMBER	QUANTITY	PACKAGING
NE696M01-T1-A	3000	Tape & Reel

NE696M01

TYPICAL NOISE PARAMETERS (T_A = 25°C)

FREQ. (GHz)	NF _{OPT} (dB)	G _A (dB)	Γ _{OPT}		R _n /50
			MAG	ANG	
V _{CE} = 1 V, I _C = 3 mA					
1.0	1.4	18.5	0.53	79	0.27
1.4	1.46	16.4	0.47	95	0.13
1.7	1.55	15.2	0.43	111	0.19
2.0	1.8	14.5	0.39	132	0.16
3.0	2.3	11.0	0.3	177	0.10
V _{CE} = 2 V, I _C = 1 mA					
0.5	.94	16.8	0.72	41	0.52
0.8	1.1	14.8	0.66	65	0.44
1.0	1.25	13.8	0.63	79	0.39
1.5	1.55	11.4	0.56	104	0.31
2.0	1.94	9.6	0.5	138	0.17
3.0	2.65	7.0	0.46	-173	0.07
V _{CE} = 2 V, I _C = 5 mA					
0.5	1.2	23.0	0.49	37	0.38
0.8	1.32	20.3	0.44	62	0.27
1.0	1.47	18.8	0.42	76	0.30
1.5	1.63	15.8	0.39	98	0.23
2.0	1.82	13.0	0.33	126	0.18
3.0	2.17	9.8	0.25	173	0.10
V _{CE} = 3 V, I _C = 5 mA					
0.5	1.25	24.2	0.5	37	0.39
0.8	1.35	20.7	0.45	62	0.26
1.0	1.41	18.8	0.44	78	0.29
1.5	1.58	15.2	0.41	97	0.24
2.0	1.81	13.7	0.34	126	0.20
3.0	2.29	12.0	0.29	164	0.09

TYPICAL PERFORMANCE CURVES (T_A = 25°C)

TOTAL POWER DISSIPATION vs. AMBIENT TEMPERATURE

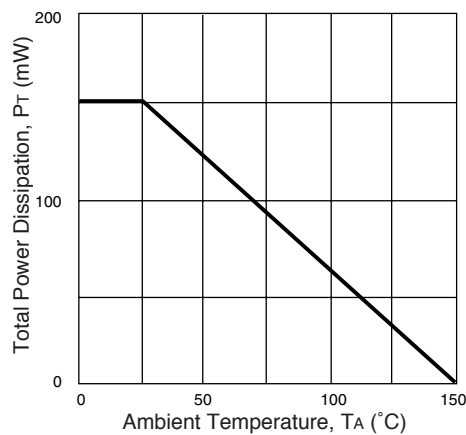

COLLECTOR CURRENT vs. BASE TO EMITTER VOLTAGE

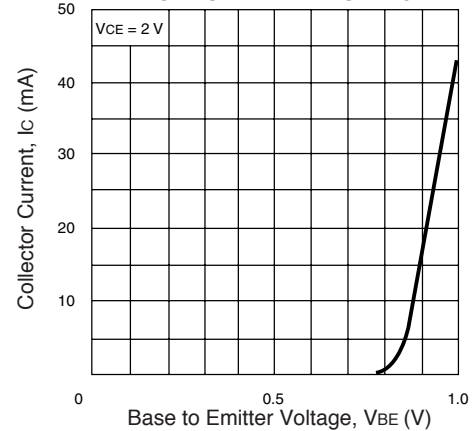

COLLECTOR CURRENT vs. COLLECTOR TO EMITTER VOLTAGE

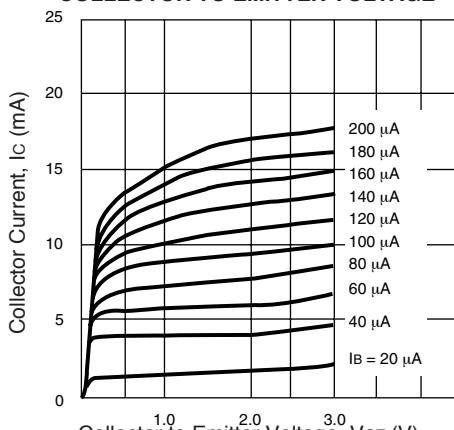

DC CURRENT GAIN vs. COLLECTOR CURRENT

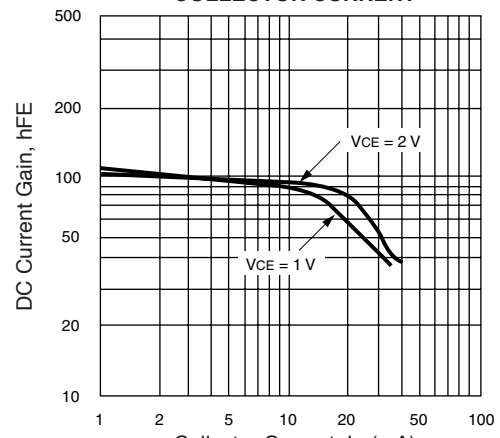

TYPICAL PERFORMANCE CURVES (TA = 25 °C)

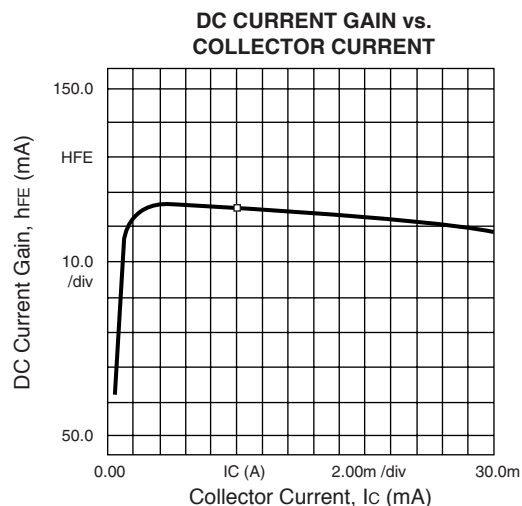
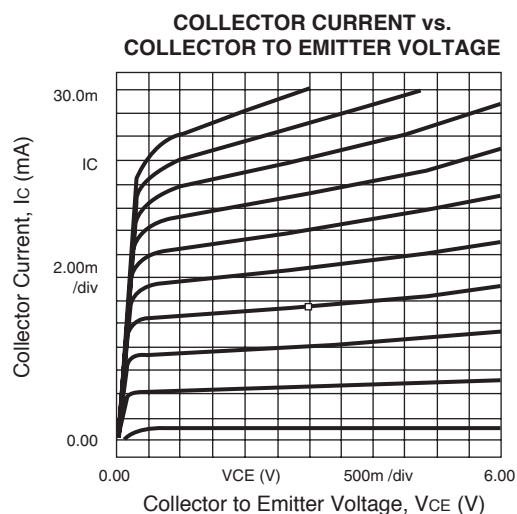

TYPICAL SCATTERING PARAMETERS (TA = 25°C)

NE696M01
VCE = 1 V, Ic = 5 mA

FREQUENCY (GHz)	S11		S21		S12		S22		K	MAG ¹ (dB)
	MAG	ANG	MAG	ANG	MAG	ANG	MAG	ANG		
0.40	0.728	-52.30	10.962	136.50	0.040	56.00	0.832	-32.90	0.303	24.378
0.50	0.684	-64.20	10.349	128.40	0.046	51.30	0.779	-39.10	0.338	23.521
0.60	0.639	-73.80	9.557	121.20	0.052	46.70	0.732	-44.00	0.398	22.643
0.70	0.594	-83.40	8.885	114.50	0.056	42.10	0.687	-48.50	0.463	22.005
0.80	0.556	-92.50	8.236	108.30	0.059	38.80	0.647	-52.30	0.522	21.449
0.90	0.522	-100.70	7.644	102.80	0.062	35.70	0.615	-55.70	0.579	20.909
1.00	0.492	-108.50	7.116	97.80	0.063	33.80	0.587	-58.60	0.640	20.529
1.20	0.442	-123.40	6.242	88.70	0.067	29.60	0.542	-64.10	0.748	19.692
1.40	0.406	-137.30	5.522	80.40	0.069	26.80	0.509	-69.10	0.860	19.032
1.60	0.380	-150.60	4.931	73.00	0.070	24.40	0.485	-73.40	0.976	18.478
1.80	0.362	-164.30	4.452	65.90	0.072	22.70	0.469	-77.90	1.069	16.304
2.00	0.353	-176.70	4.047	59.30	0.074	21.90	0.459	-81.80	1.151	15.018
2.25	0.351	167.30	3.606	51.40	0.075	20.20	0.451	-86.70	1.270	13.695
2.50	0.360	152.60	3.248	43.80	0.077	20.20	0.449	-91.40	1.353	12.702
2.75	0.377	138.80	2.942	36.40	0.079	19.30	0.453	-96.10	1.417	11.872
3.00	0.397	127.30	2.676	29.70	0.081	18.50	0.458	-100.50	1.475	11.110
3.50	0.451	107.70	2.251	16.40	0.085	18.50	0.477	-108.90	1.530	9.936
4.00	0.498	93.20	1.930	4.10	0.092	17.50	0.496	-118.00	1.515	8.980
4.50	0.538	82.30	1.690	-7.90	0.101	16.20	0.513	-128.80	1.460	8.216
5.00	0.567	74.10	1.509	-19.70	0.113	13.60	0.532	-142.40	1.371	7.622
5.50	0.587	67.30	1.361	-31.50	0.127	9.40	0.555	-158.60	1.283	7.107
6.00	0.608	61.10	1.229	-43.20	0.141	4.00	0.593	-175.70	1.175	6.870
6.50	0.630	55.20	1.091	-54.40	0.155	-1.40	0.637	168.60	1.077	6.778
7.00	0.657	49.10	0.949	-63.80	0.164	-6.40	0.678	157.90	1.009	7.057
7.50	0.690	42.90	0.818	-70.40	0.171	-9.20	0.719	154.80	0.911	6.798

Note:
1. Gain Calculation:

$$MAG = \frac{|S_{21}|}{|S_{12}|} \left(K \pm \sqrt{K^2 - 1} \right). \text{ When } K \leq 1, \text{ MAG is undefined and MSG values are used. } MSG = \frac{|S_{21}|}{|S_{12}|}, K = \frac{1 + |\Delta|^2 - |S_{11}|^2 - |S_{22}|^2}{2 |S_{12} S_{21}|}, \Delta = S_{11} S_{22} - S_{21} S_{12}$$

MAG = Maximum Available Gain
MSG = Maximum Stable Gain

NE696M01

TYPICAL SCATTERING PARAMETERS (T_A = 25°C)

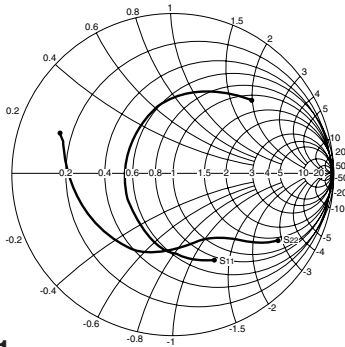

Coordinates in Ohms
Frequency in GHz
VCE = 2 V, I_c = 10 mA

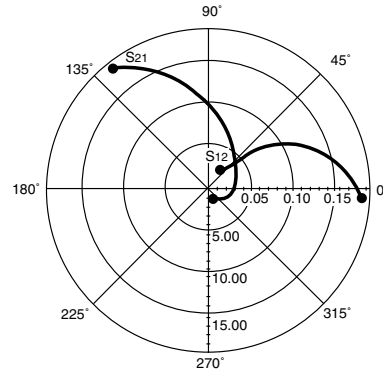

NE696M01

VCE = 2 V, I_c = 1 mA

FREQUENCY GHz	S ₁₁		S ₂₁		S ₁₂		S ₂₂		K	MAG ¹ (dB)
	MAG	ANG	MAG	ANG	MAG	ANG	MAG	ANG		
0.40	0.941	-25.2	2.924	154.2	0.037	67.9	0.977	-16.3	0.181	18.978
0.80	0.874	-49.7	2.776	132.3	0.066	51.3	0.930	-31.3	0.255	16.239
1.00	0.833	-61.1	2.642	122.1	0.077	43.1	0.904	-37.9	0.315	15.354
2.00	0.610	-119.1	2.104	75.2	0.097	9.5	0.798	-66.0	0.662	13.363
2.50	0.536	-150.6	1.808	54.7	0.090	-2.7	0.765	-77.3	0.919	13.030
3.00	0.502	176.8	1.551	36.1	0.077	-10.4	0.755	-87.4	1.238	10.100
4.00	0.550	123.5	1.121	4.0	0.053	-0.2	0.769	-107.1	2.016	7.495
5.00	0.617	93.4	0.852	-22.3	0.071	25.0	0.789	-133.7	1.607	6.222
6.00	0.660	74.9	0.665	-45.6	0.116	21.5	0.821	-169.3	1.048	6.238

VCE = 2 V, I_c = 5 mA

0.40	0.753	-46.2	11.297	139.6	0.030	59.6	0.871	-27.0	0.296	25.758
0.80	0.583	-83.4	8.809	111.9	0.047	43.1	0.715	-43.8	0.509	22.728
1.00	0.513	-98.3	7.704	101.4	0.051	37.7	0.660	-49.4	0.628	21.791
2.00	0.338	-165.4	4.496	61.9	0.059	27.5	0.541	-70.7	1.163	16.374
2.50	0.333	161.7	3.634	46.0	0.062	27.6	0.530	-80.0	1.357	14.112
3.00	0.366	134.1	3.005	31.6	0.066	27.8	0.538	-89.2	1.460	12.563
4.00	0.468	97.3	2.169	5.4	0.081	29.4	0.575	-107.7	1.386	10.575
5.00	0.543	77.4	1.697	-19.0	0.107	25.2	0.610	-132.7	1.152	9.638
6.00	0.591	64.3	1.381	-43.2	0.141	14.8	0.666	-167.0	0.921	9.910

Note:

1. Gain Calculation:

$$\text{MAG} = \frac{|S_{21}|}{|S_{12}|} \left(K \pm \sqrt{K^2 - 1} \right). \text{ When } K \leq 1, \text{ MAG is undefined and MSG values are used. } \text{MSG} = \frac{|S_{21}|}{|S_{12}|}, K = \frac{1 + |\Delta|^2 - |S_{11}|^2 - |S_{22}|^2}{2 |S_{12} S_{21}|}, \Delta = S_{11} S_{22} - S_{21} S_{12}$$

MAG = Maximum Available Gain

MSG = Maximum Stable Gain

TYPICAL SCATTERING PARAMETERS ($T_A = 25^\circ\text{C}$)

NE696M01

VCE = 3 V, Ic = 5 mA

FREQUENCY (GHz)	S11		S21		S12		S22		K	MAG ¹ (dB)
	MAG	ANG	MAG	ANG	MAG	ANG	MAG	ANG		
0.40	0.765	-43.9	11.370	140.8	0.028	60.3	0.885	-25.1	0.299	26.086
0.80	0.596	-79.7	8.988	113.4	0.043	44.4	0.739	-41.1	0.506	23.202
1.00	0.525	-94.2	7.898	102.7	0.046	39.6	0.687	-46.5	0.627	22.348
2.00	0.335	-160.2	4.669	63.0	0.054	30.6	0.573	-67.5	1.159	16.952
2.50	0.323	166.2	3.781	47.0	0.057	30.6	0.562	-76.6	1.352	14.673
3.00	0.353	137.5	3.134	32.4	0.062	31.8	0.570	-85.9	1.422	13.178
4.00	0.456	99.2	2.266	5.9	0.078	34.1	0.606	-104.5	1.312	11.285
5.00	0.533	78.9	1.773	-18.6	0.106	29.7	0.642	-129.8	1.053	10.827
6.00	0.583	65.7	1.442	-43.1	0.142	18.5	0.695	-164.2	0.823	10.067

Note:

1. Gain Calculation:

$$\text{MAG} = \frac{|S_{21}|}{|S_{12}|} \left(K \pm \sqrt{K^2 - 1} \right). \text{ When } K \leq 1, \text{ MAG is undefined and MSG values are used. } \text{MSG} = \frac{|S_{21}|}{|S_{12}|}, K = \frac{1 + |\Delta|^2 - |S_{11}|^2 - |S_{22}|^2}{2 |S_{12} S_{21}|}, \Delta = S_{11} S_{22} - S_{21} S_{12}$$

MAG = Maximum Available Gain

MSG = Maximum Stable Gain

NE696M01 NONLINEAR MODEL

SCHEMATIC

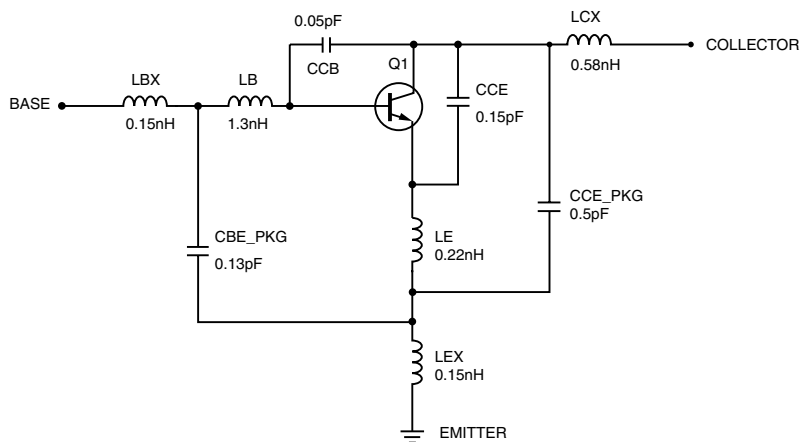
BJT NONLINEAR MODEL PARAMETERS ⁽¹⁾

Parameters	Q1	Parameters	Q1
IS	7e-16	MJC	0.34
BF	119	XCJC	0.6
NF	1.06	CJS	0
VAF	20.5	VJS	0.75
IKF	0.18	MJS	0
ISE	1e-13	FC	0.5
NE	2	TF	4e-12
BR	6.5	XTF	5.2
NR	1.08	VTF	4.58
VAR	18	ITF	0.01
IKR	0.015	PTF	0
ISC	0	TR	1e-9
NC	2	EG	1.11
RE	1.23	XTB	0
RB	11	XTI	3
RBM	2.5	KF	0
IRB	0.009	AF	1
RC	5		
CJE	0.4e-12		
VJE	0.68		
MJE	0.5		
CJC	0.18e-12		
VJC	0.5		

(1) Gummel-Poon Model

Life Support Applications

These NEC products are not intended for use in life support devices, appliances, or systems where the malfunction of these products can reasonably be expected to result in personal injury. The customers of CEL using or selling these products for use in such applications do so at their own risk and agree to fully indemnify CEL for all damages resulting from such improper use or sale.

UNITS

Parameter	Units
time	seconds
capacitance	farads
inductance	henries
resistance	ohms
voltage	volts
current	amps

ADDITIONAL PARAMETERS

Parameters	696M01
CCB	0.05e-12
CCE	0.15e-12
LB	1.3e-9
LE	0.22e-9
CCEPKG	0.5e-12
CBEPKG	0.13e-12
LBX	0.15e-9
LCX	0.58e-9
LEX	0.15e-9

MODEL RANGE

Frequency: 0.4 to 7.5 GHz
Bias: $V_{CE} = 0.5 \text{ V to } 5 \text{ V}$, $I_C = 0.5 \text{ mA to } 10 \text{ mA}$
Date: 2/6/97

Subject: Compliance with EU Directives

CEL certifies, to its knowledge, that semiconductor and laser products detailed below are compliant with the requirements of European Union (EU) Directive 2002/95/EC Restriction on Use of Hazardous Substances in electrical and electronic equipment (RoHS) and the requirements of EU Directive 2003/11/EC Restriction on Penta and Octa BDE.

CEL Pb-free products have the same base part number with a suffix added. The suffix –A indicates that the device is Pb-free. The –AZ suffix is used to designate devices containing Pb which are exempted from the requirement of RoHS directive (*). In all cases the devices have Pb-free terminals. All devices with these suffixes meet the requirements of the RoHS directive.

This status is based on CEL’s understanding of the EU Directives and knowledge of the materials that go into its products as of the date of disclosure of this information.

Restricted Substance per RoHS	Concentration Limit per RoHS (values are not yet fixed)	Concentration contained in CEL devices	
		-A	-AZ
Lead (Pb)	< 1000 PPM	Not Detected	(*)
Mercury	< 1000 PPM	Not Detected	
Cadmium	< 100 PPM	Not Detected	
Hexavalent Chromium	< 1000 PPM	Not Detected	
PBB	< 1000 PPM	Not Detected	
PBDE	< 1000 PPM	Not Detected	

If you should have any additional questions regarding our devices and compliance to environmental standards, please do not hesitate to contact your local representative.

Important Information and Disclaimer: Information provided by CEL on its website or in other communications concerning the substance content of its products represents knowledge and belief as of the date that it is provided. CEL bases its knowledge and belief on information provided by third parties and makes no representation or warranty as to the accuracy of such information. Efforts are underway to better integrate information from third parties. CEL has taken and continues to take reasonable steps to provide representative and accurate information but may not have conducted destructive testing or chemical analysis on incoming materials and chemicals. CEL and CEL suppliers consider certain information to be proprietary, and thus CAS numbers and other limited information may not be available for release.

In no event shall CEL’s liability arising out of such information exceed the total purchase price of the CEL part(s) at issue sold by CEL to customer on an annual basis.

See CEL Terms and Conditions for additional clarification of warranties and liability.