

International IOR Rectifier

PD - 96111

IRF7379QPbF

HEXFET® Power MOSFET

- Advanced Process Technology
- Ultra Low On-Resistance
- Dual N and P Channel MOSFET
- Surface Mount
- Available in Tape & Reel
- 150°C Operating Temperature
- Automotive [Q101] Qualified
- Lead-Free

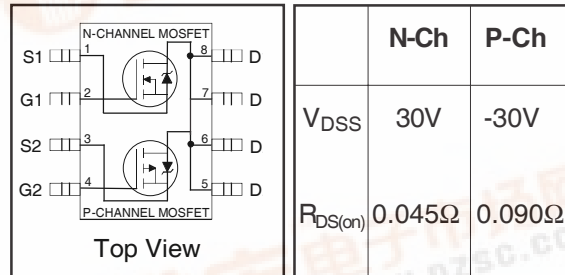

Description

Specifically designed for Automotive applications, these HEXFET® Power MOSFET's in a Dual SO-8 package utilize the latest processing techniques to achieve extremely low on-resistance per silicon area. Additional features of these Automotive qualified HEXFET Power MOSFET's are a 150°C junction operating temperature, fast switching speed and improved repetitive avalanche rating. These benefits combine to make this design an extremely efficient and reliable device for use in Automotive applications and a wide variety of other applications.

The efficient SO-8 package provides enhanced thermal characteristics and dual MOSFET die capability making it ideal in a variety of power applications. This dual, surface mount SO-8 can dramatically reduce board space and is also available in Tape & Reel.

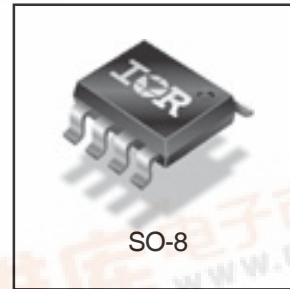

Absolute Maximum Ratings

	Parameter	Max.		Units
		N-Channel	P-Channel	
V_{SD}	Drain-to-Source Voltage	30	-30	
$I_D @ T_A = 25^\circ\text{C}$	Continuous Drain Current, $V_{GS} @ 10\text{V}$	5.8	-4.3	A
$I_D @ T_A = 70^\circ\text{C}$	Continuous Drain Current, $V_{GS} @ 10\text{V}$	4.6	-3.4	
I_{DM}	Pulsed Drain Current ①	46	-34	
$P_D @ T_A = 25^\circ\text{C}$	Power Dissipation	2.5		W
	Linear Derating Factor	0.02		W/°C
V_{GS}	Gate-to-Source Voltage	± 20		V
dv/dt	Peak Diode Recovery dv/dt ②	5.0	-5.0	V/ns
T_J, T_{STG}	Junction and Storage Temperature Range	-55 to + 150		°C

Thermal Resistance Ratings

	Parameter	Max.	Units
$R_{\theta JA}$	Maximum Junction-to-Ambient③	50	°C/W

www.irf.com

1



IRF7379QPbF

International
IR Rectifier

Electrical Characteristics @ T_J = 25°C (unless otherwise specified)

Parameter	Description		Min.	Typ.	Max.	Units	Conditions
V _{(BR)DSS}	Drain-to-Source Breakdown Voltage	N-Ch	30	—	—	V	V _{GS} = 0V, I _D = 250μA
		P-Ch	-30	—	—		V _{GS} = 0V, I _D = -250μA
ΔV _{(BR)DSS} /ΔT _J	Breakdown Voltage Temp. Coefficient	N-Ch	—	0.032	—	V/°C	Reference to 25°C, I _D = 1mA
		P-Ch	—	-0.037	—		Reference to 25°C, I _D = -1mA
R _{DS(ON)}	Static Drain-to-Source On-Resistance	N-Ch	—	0.038	0.045	Ω	V _{GS} = 10V, I _D = 5.8A ③
			—	0.055	0.075		V _{GS} = 4.5V, I _D = 4.9A ③
		P-Ch	—	0.070	0.090		V _{GS} = -10V, I _D = -4.3A ③
			—	0.130	0.180		V _{GS} = -4.5V, I _D = -3.7A ③
V _{GS(th)}	Gate Threshold Voltage	N-Ch	1.0	—	—	V	V _{DS} = V _{GS} , I _D = 250μA
		P-Ch	-1.0	—	—		V _{DS} = V _{GS} , I _D = -250μA
g _{fs}	Forward Transconductance	N-Ch	5.2	—	—	S	V _{DS} = 15V, I _D = 2.4A ③
		P-Ch	2.5	—	—		V _{DS} = -24V, I _D = -1.8A ③
I _{DSS}	Drain-to-Source Leakage Current	N-Ch	—	—	1.0	μA	V _{DS} = 24V, V _{GS} = 0V
		P-Ch	—	—	-1.0		V _{DS} = -24V, V _{GS} = 0V
		N-Ch	—	—	25		V _{DS} = 24V, V _{GS} = 0V, T _J = 125°C
		P-Ch	—	—	-25		V _{DS} = -24V, V _{GS} = 0V, T _J = 125°C
I _{GSS}	Gate-to-Source Forward Leakage	N-P	—	—	±100	μA	V _{GS} = ±20V
Q _g	Total Gate Charge	N-Ch	—	—	25	nC	N-Channel I _D = 2.4A, V _{DS} = 24V, V _{GS} = 10V ③
		P-Ch	—	—	25		
Q _{gs}	Gate-to-Source Charge	N-Ch	—	—	2.9	nC	P-Channel I _D = -1.8A, V _{DS} = -24V, V _{GS} = -10V ③
		P-Ch	—	—	2.9		
Q _{gd}	Gate-to-Drain ("Miller") Charge	N-Ch	—	—	7.9	nC	P-Channel I _D = -1.8A, V _{DS} = -24V, V _{GS} = -10V ③
		P-Ch	—	—	9.0		
t _{d(on)}	Turn-On Delay Time	N-Ch	—	6.8	—	ns	N-Channel V _{DD} = 15V, I _D = 2.4A, R _G = 6.0Ω, R _D = 6.2Ω ③
		P-Ch	—	11	—		
t _r	Rise Time	N-Ch	—	21	—	ns	P-Channel V _{DD} = -15V, I _D = -1.8A, R _G = 6.0Ω, R _D = 8.2Ω ③
		P-Ch	—	17	—		
t _{d(off)}	Turn-Off Delay Time	N-Ch	—	22	—	ns	P-Channel V _{DD} = -15V, I _D = -1.8A, R _G = 6.0Ω, R _D = 8.2Ω ③
		P-Ch	—	25	—		
t _f	Fall Time	N-Ch	—	7.7	—	ns	P-Channel V _{DD} = -15V, I _D = -1.8A, R _G = 6.0Ω, R _D = 8.2Ω ③
		P-Ch	—	18	—		
L _D	Internal Drain Inductance	N-P	—	4.0	—	nH	Between lead, 6mm (0.25in.) from package and center of die contact
L _S	Internal Source Inductance	N-P	—	6.0	—		
C _{iss}	Input Capacitance	N-Ch	—	520	—	pF	N-Channel V _{GS} = 0V, V _{DS} = 25V, f = 1.0MHz ③
		P-Ch	—	440	—		
C _{oss}	Output Capacitance	N-Ch	—	180	—	pF	P-Channel V _{GS} = 0V, V _{DS} = -25V, f = 1.0MHz ③
		P-Ch	—	200	—		
C _{rss}	Reverse Transfer Capacitance	N-Ch	—	72	—	pF	P-Channel V _{GS} = 0V, V _{DS} = -25V, f = 1.0MHz ③
		P-Ch	—	93	—		

Source-Drain Ratings and Characteristics

Parameter	Description		Min.	Typ.	Max.	Units	Conditions
I _S	Continuous Source Current (Body Diode)	N-Ch	—	—	3.1	A	
		P-Ch	—	—	-3.1		
I _{SM}	Pulsed Source Current (Body Diode) ①	N-Ch	—	—	46	A	
		P-Ch	—	—	-34		
V _{SD}	Diode Forward Voltage	N-Ch	—	—	1.0	V	T _J = 25°C, I _S = 1.8A, V _{GS} = 0V ③
		P-Ch	—	—	-1.0		T _J = 25°C, I _S = -1.8A, V _{GS} = 0V ③
t _{rr}	Reverse Recovery Time	N-Ch	—	47	71	ns	N-Channel T _J = 25°C, I _F = 2.4A, di/dt = 100A/μs ③
		P-Ch	—	53	80		
Q _{rr}	Reverse Recovery Charge	N-Ch	—	56	84	nC	P-Channel T _J = 25°C, I _F = -1.8A, di/dt = -100A/μs ③
		P-Ch	—	66	99		

Notes:

- ① Repetitive rating; pulse width limited by max. junction temperature. (See fig. 10)
- ② N-Channel I_{SD} ≤ 2.4A, di/dt ≤ 73A/μs, V_{DD} ≤ V_{(BR)DSS}, T_J ≤ 150°C
P-Channel I_{SD} ≤ -1.8A, di/dt ≤ 90A/μs, V_{DD} ≤ V_{(BR)DSS}, T_J ≤ 150°C
- ③ Pulse width ≤ 300μs; duty cycle ≤ 2%.
- ④ Surface mounted on FR-4 board, t ≤ 10sec.

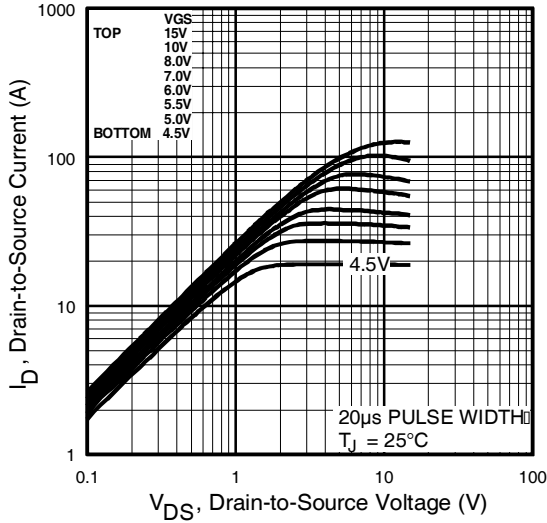

Fig 1. Typical Output Characteristics

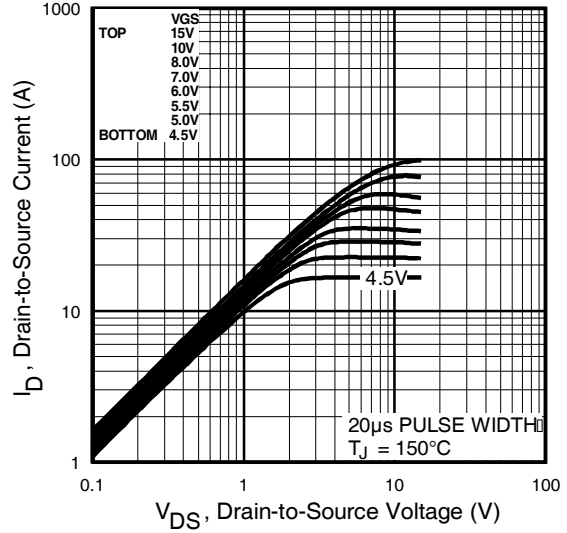

Fig 2. Typical Output Characteristics

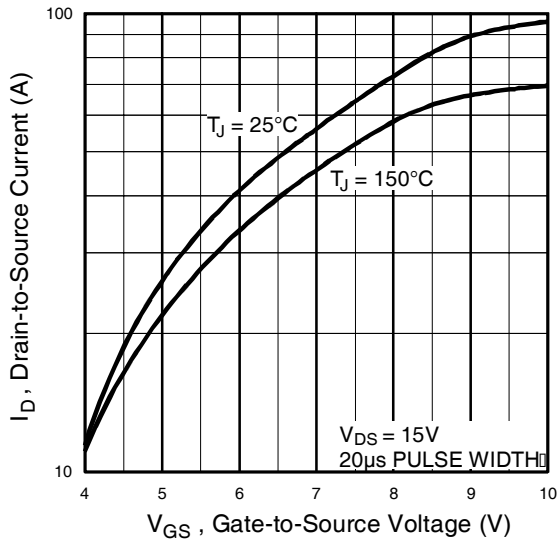

Fig 3. Typical Transfer Characteristics

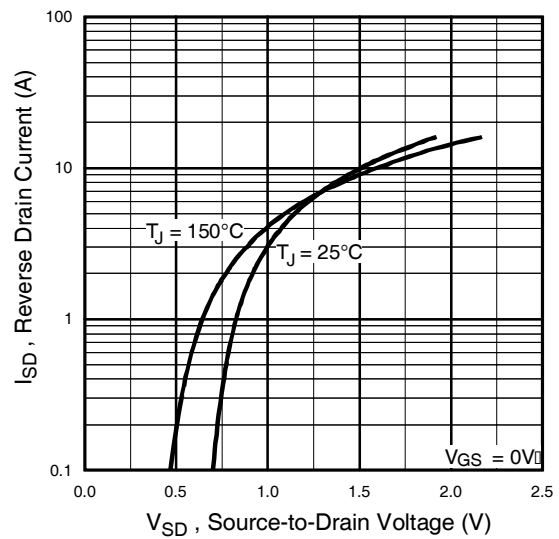

Fig 4. Typical Source-Drain Diode Forward Voltage

IRF7379QPbF

N-Channel

International
IR Rectifier

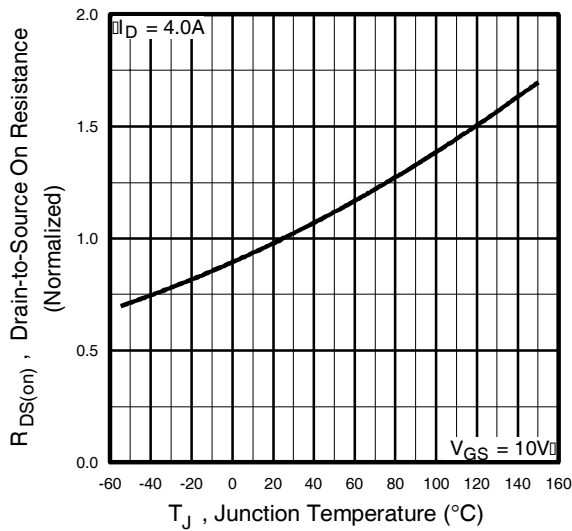

Fig 5. Normalized On-Resistance Vs. Temperature

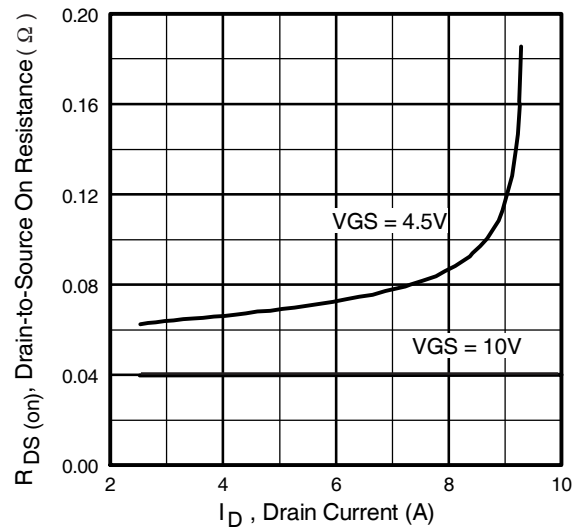

Fig 6. Typical On-Resistance Vs. Drain Current

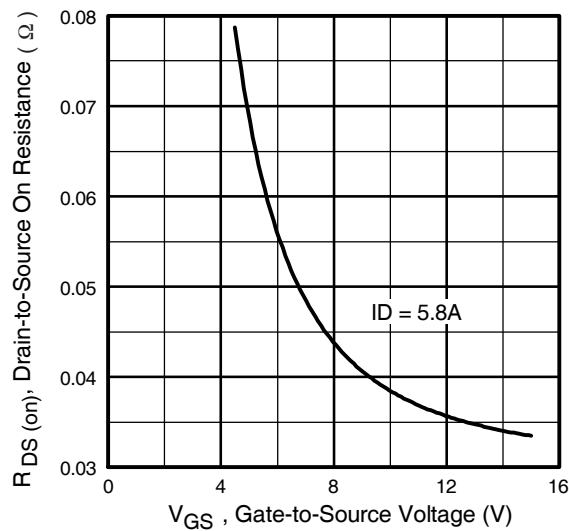

Fig 7. Typical On-Resistance Vs. Gate Voltage

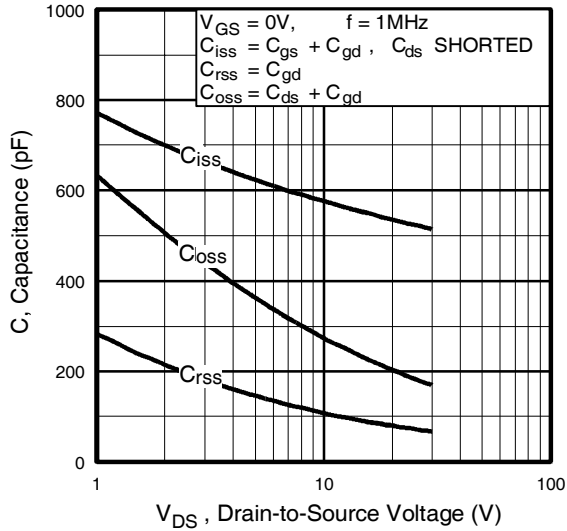

Fig 8. Typical Capacitance Vs. Drain-to-Source Voltage

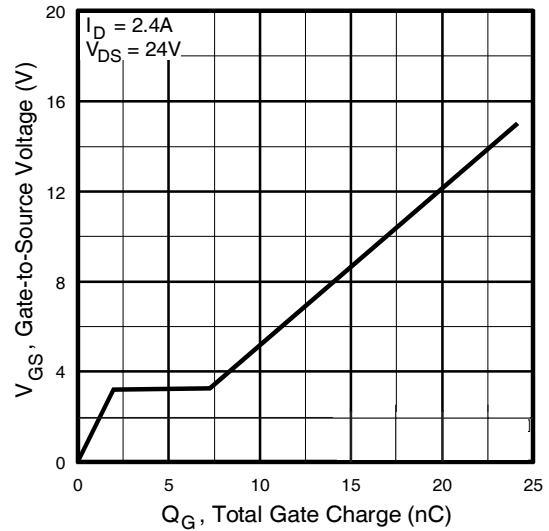

Fig 9. Typical Gate Charge Vs. Gate-to-Source Voltage

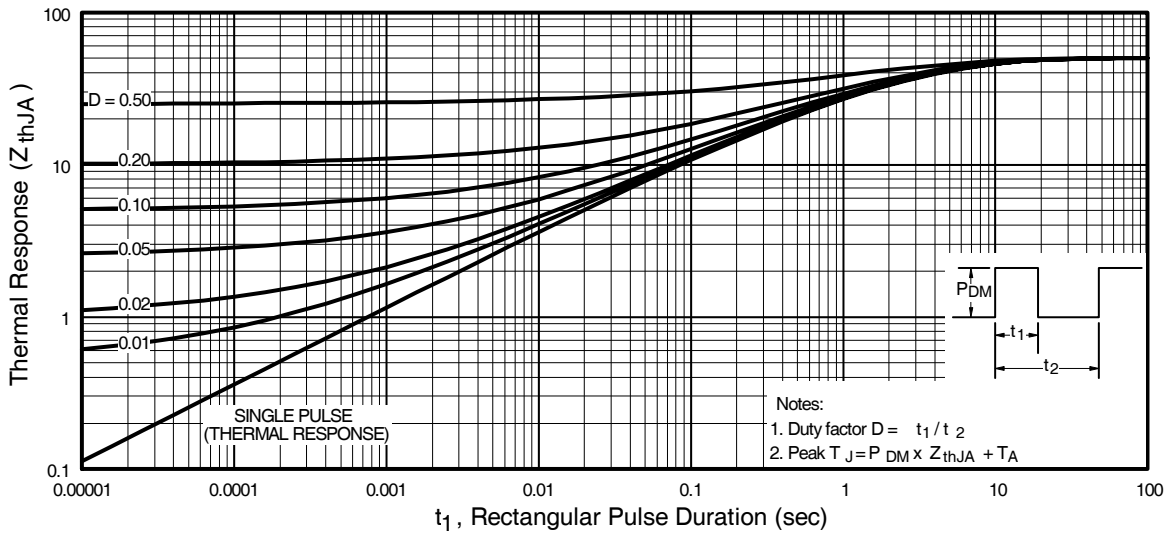

Fig 10. Maximum Effective Transient Thermal Impedance, Junction-to-Ambient

IRF7379QPbF

P-Channel

International
IR Rectifier

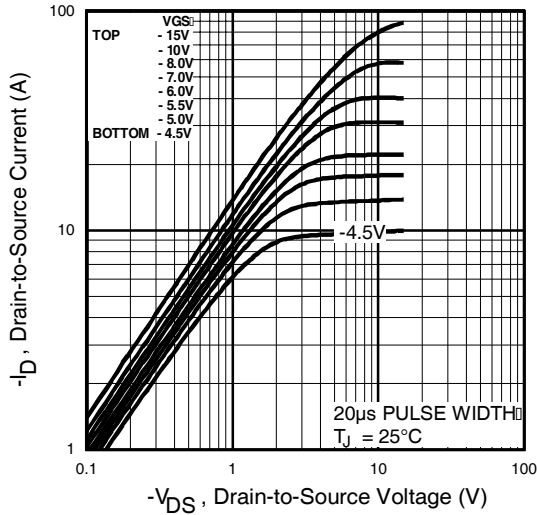

Fig 11. Typical Output Characteristics

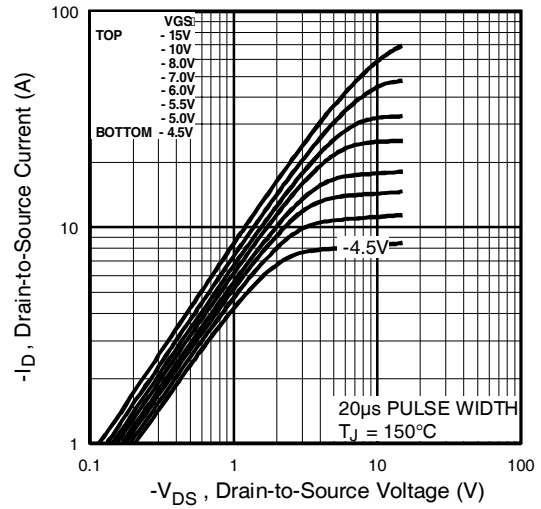

Fig 12. Typical Output Characteristics

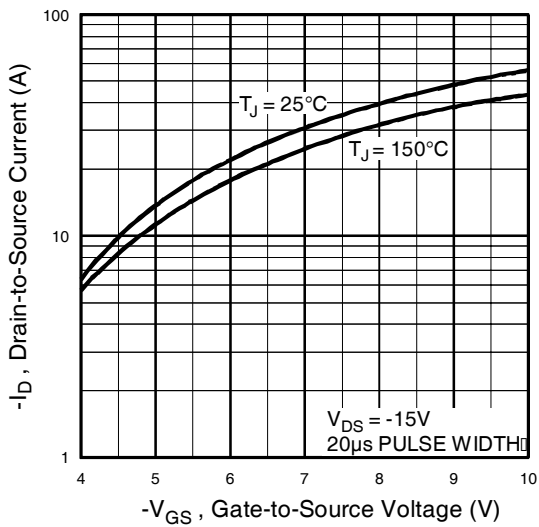

Fig 13. Typical Transfer Characteristics

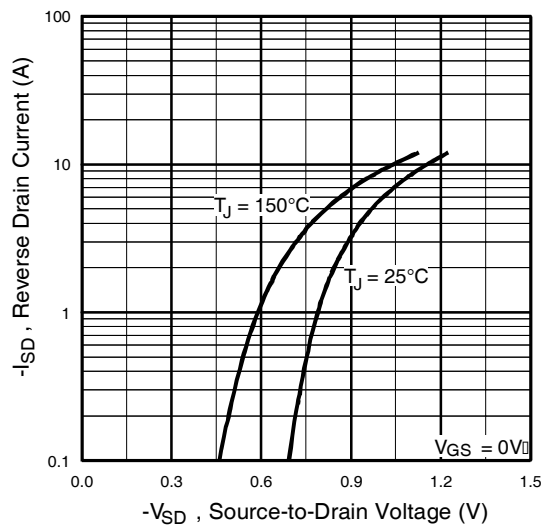

Fig 14. Typical Source-Drain Diode Forward Voltage

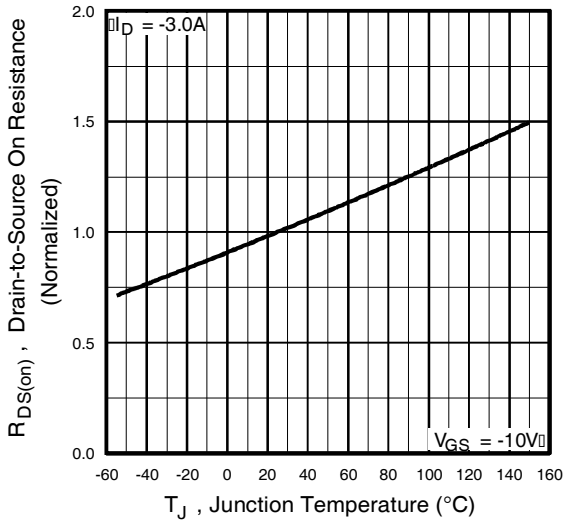

Fig 15. Normalized On-Resistance Vs. Temperature

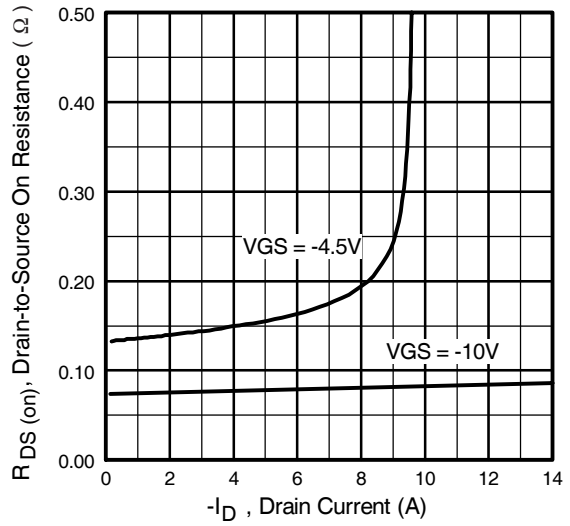

Fig 16. Typical On-Resistance Vs. Drain Current

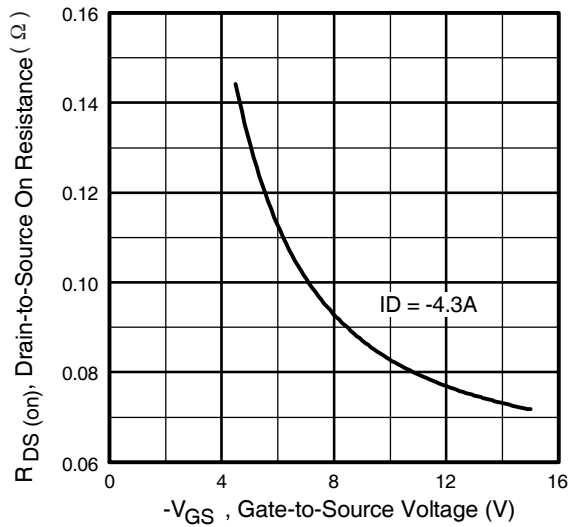

Fig 17. Typical On-Resistance Vs. Gate Voltage

IRF7379QPbF

P-Channel

International
IR Rectifier

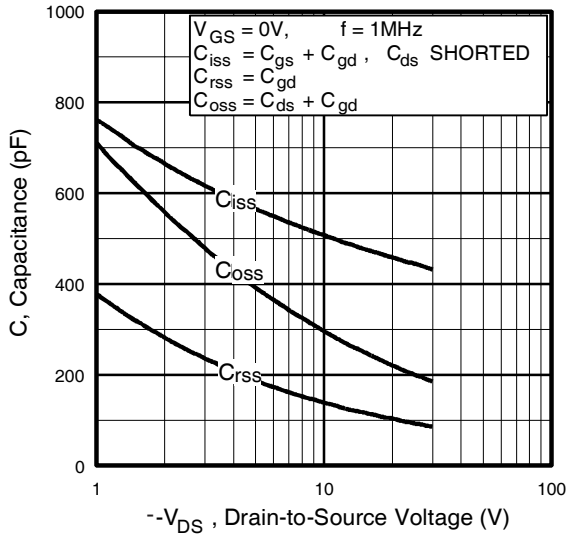

Fig 18. Typical Capacitance Vs. Drain-to-Source Voltage

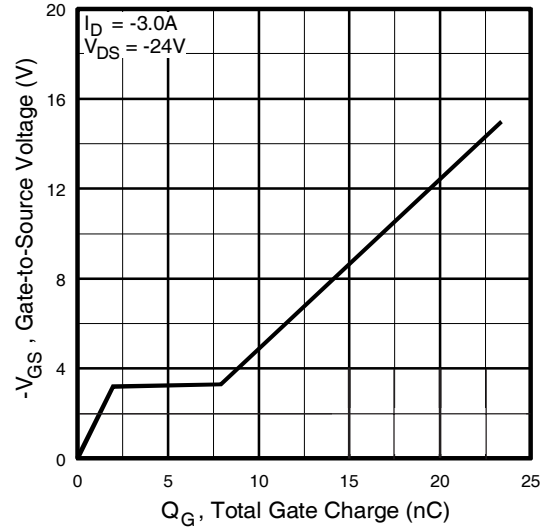

Fig 19. Typical Gate Charge Vs. Gate-to-Source Voltage

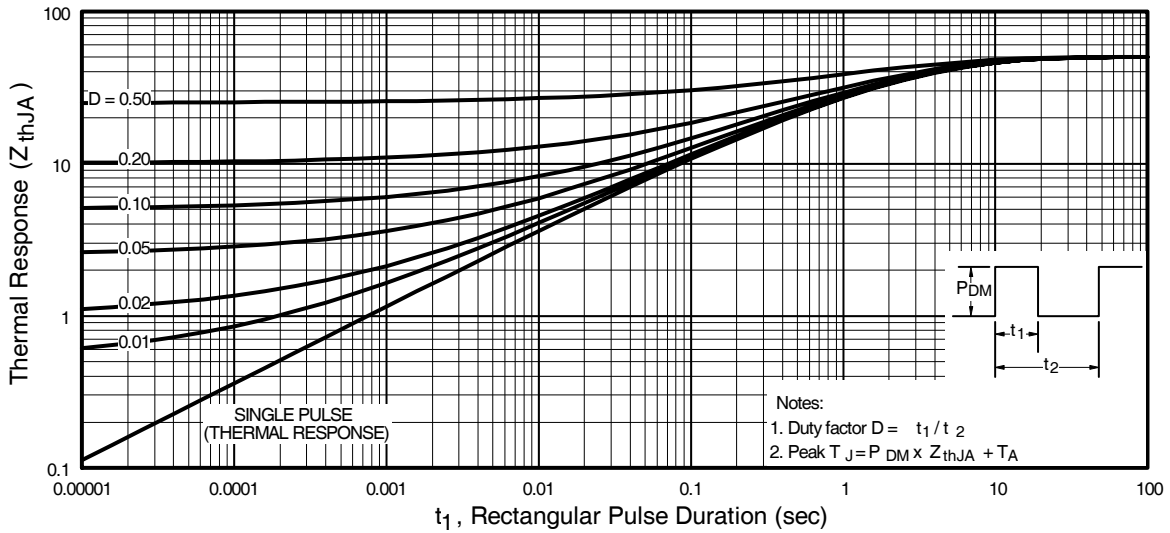
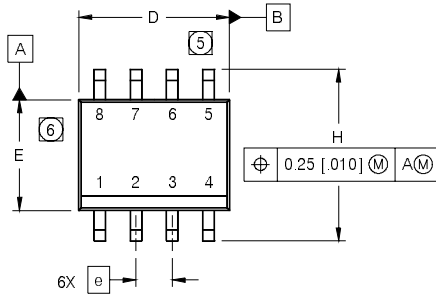

Fig 20. Maximum Effective Transient Thermal Impedance, Junction-to-Ambient

SO-8 Package Outline

Dimensions are shown in millimeters (inches)



DIM	INCHES		MILLIMETERS	
	MIN	MAX	MIN	MAX
A	.0532	.0688	1.35	1.75
A1	.0040	.0098	0.10	0.25
b	.013	.020	0.33	0.51
c	.0075	.0098	0.19	0.25
D	.189	.1968	4.80	5.00
E	.1497	.1574	3.80	4.00
e	.050 BASIC		1.27 BASIC	
e1	.025 BASIC		0.635 BASIC	
H	.2284	.2440	5.80	6.20
K	.0099	.0196	0.25	0.50
L	.016	.050	0.40	1.27
y	0°	8°	0°	8°

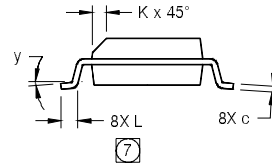
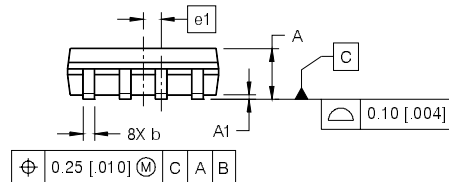

NOTES:

1. DIMENSIONING & TOLERANCING PER ASME Y14.5M-1994.
2. CONTROLLING DIMENSION: MILLIMETER
3. DIMENSIONS ARE SHOWN IN MILLIMETERS [INCHES].
4. OUTLINE CONFORMS TO JEDEC OUTLINE MS-012AA.
- 5 DIMENSION DOES NOT INCLUDE MOLD PROTRUSIONS. MOLD PROTRUSIONS NOT TO EXCEED 0.15 [0.006].
- 6 DIMENSION DOES NOT INCLUDE MOLD PROTRUSIONS. MOLD PROTRUSIONS NOT TO EXCEED 0.25 [0.010].
- 7 DIMENSION IS THE LENGTH OF LEAD FOR SOLDERING TO A SUBSTRATE.

FOOTPRINT

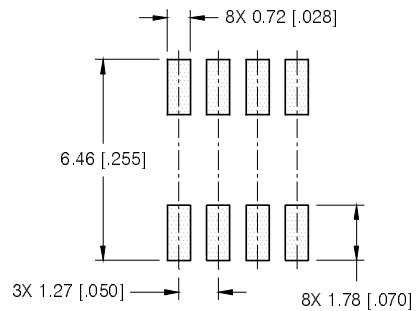

SO-8 Part Marking

EXAMPLE: THIS IS AN IRF7101 (MOSFET)

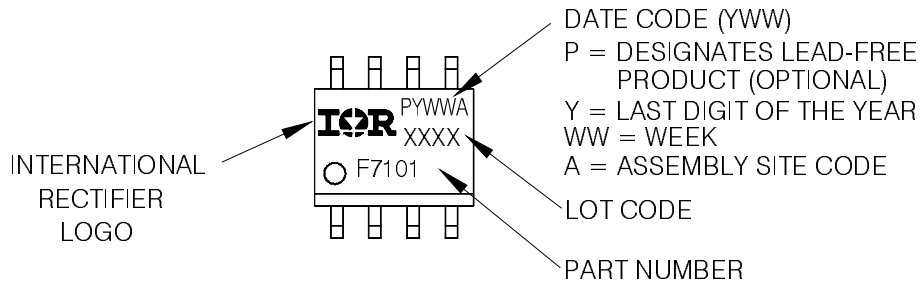

Note: For the most current drawing please refer to IR website at <http://www.irf.com/package/>

IRF7379QPbF

International
IR Rectifier

SO-8 Tape and Reel

Dimensions are shown in millimeters (inches)

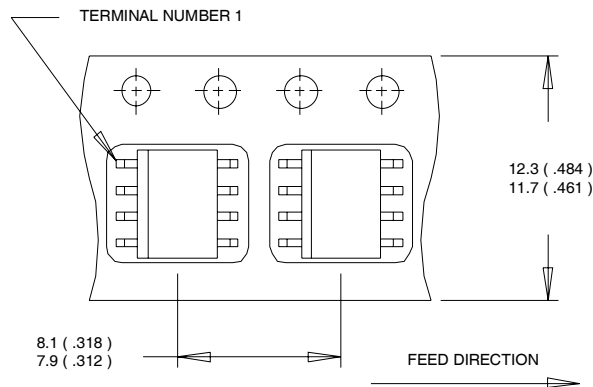

NOTES:

1. CONTROLLING DIMENSION : MILLIMETER.
2. ALL DIMENSIONS ARE SHOWN IN MILLIMETERS(INCHES).
3. OUTLINE CONFORMS TO EIA-481 & EIA-541.

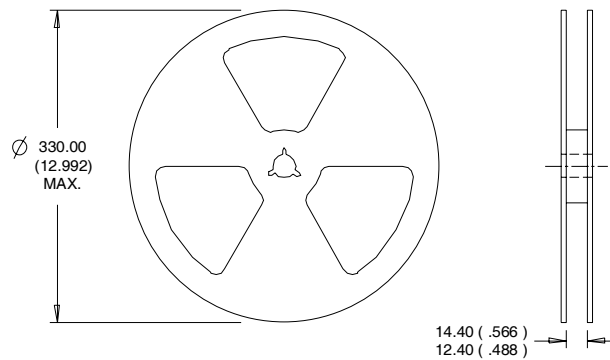

NOTES :

1. CONTROLLING DIMENSION : MILLIMETER.
2. OUTLINE CONFORMS TO EIA-481 & EIA-541.

Note: For the most current drawing please refer to IR website at <http://www.irf.com/package/>

Data and specifications subject to change without notice.
This product has been designed and qualified for the Automotive [Q101] market.
Qualification Standards can be found on IR's Web site.

International
IR Rectifier

IR WORLD HEADQUARTERS: 233 Kansas St., El Segundo, California 90245, USA Tel: (310) 252-7105
TAC Fax: (310) 252-7903

Visit us at www.irf.com for sales contact information.07/2007