



查询SC8863-300TSKTR供应商

SEMTECH

捷多邦, 专业PCB打样工厂, 24小时加急出货

SC8863

150mA Ultra Low Dropout, Low Noise Regulator

POWER MANAGEMENT

Description

The SC8863 is a low dropout linear regulator that operates from a +2.5V to +6.0V input range and delivers up to 150mA. A PMOS pass transistor allows the low 110µA supply current to remain independent of load, making these devices ideal for battery operated portable equipment such as cellular phones, cordless phones and personal digital assistants.

The SC8863 output voltage can be preset or adjusted with an external resistor divider. Other features include low power shutdown, short circuit protection, thermal shutdown protection and reverse battery protection. The SC8863 comes in the tiny 5 lead SOT-23 package (lead free, fully WEEE and RoHS compliant available) and the ultra low profile 5 lead TSOT-23.

Features

- ◆ Guaranteed 150mA output current
- ◆ Works with ceramic capacitors
- ◆ Fixed or adjustable output
- ◆ Very small external components
- ◆ Low 75µV_{RMS} output noise
- ◆ Very low supply current
- ◆ Thermal overload protection
- ◆ Reverse battery protection
- ◆ Low power shutdown
- ◆ Full industrial temperature range
- ◆ Very low profile packaging available (1mm max. height)
- ◆ Surface mount packaging (SOT-23-5 and TSOT-23-5)

Applications

- ◆ Battery Powered Systems
- ◆ Cellular Telephones
- ◆ Cordless Telephones
- ◆ Personal Digital Assistants
- ◆ Portable Instrumentation
- ◆ Modems
- ◆ PCMCIA cards

Typical Application Circuits

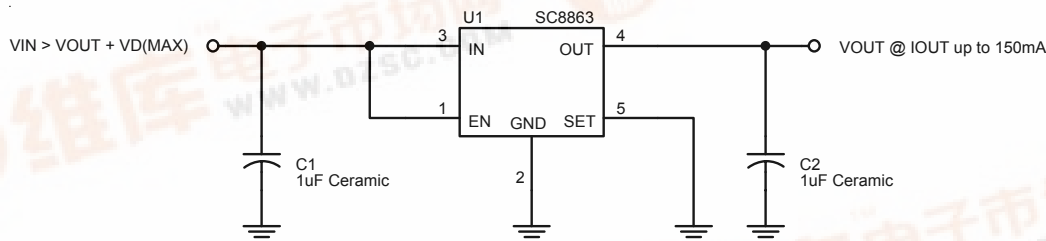

Internally Preset Output Voltage

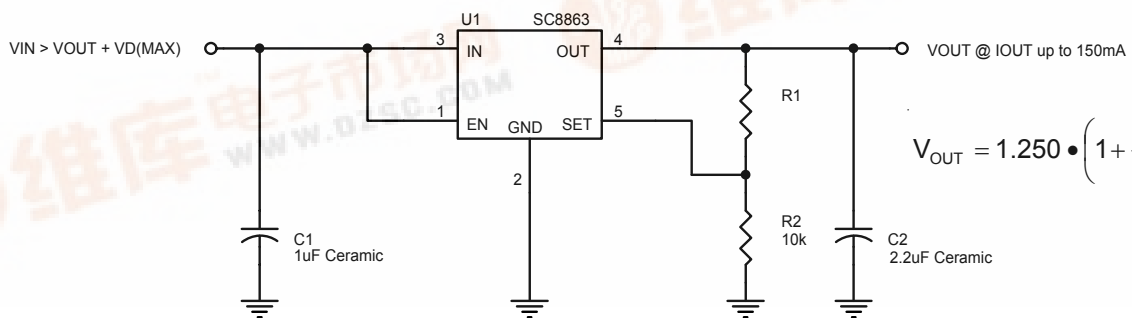

Externally Preset Output Voltage⁽⁴⁾

$$V_{OUT} = 1.250 \cdot \left(1 + \frac{R1}{R2}\right)$$

⁽⁴⁾ Select R1 and R2 such that the current flowing through them is ≥ 10µA (i.e. R2 ≤ 120kΩ). A value of 10kΩ is recommended for R2. Please see Component Selection - Externally Set Output on page 7.



POWER MANAGEMENT
Absolute Maximum Ratings

Exceeding the specifications below may result in permanent damage to the device, or device malfunction. Operation outside of the parameters specified in the Electrical Characteristics section is not implied.

Parameter	Symbol	Maximum	Units
EN, IN, OUT, SET to GND	V_{PIN}	-0.3 to +7	V
Output Short Circuit Duration	t_{SC}	Infinite	s
Thermal Resistance, Junction to Ambient	θ_{JA}	256	°C/W
Thermal Resistance, Junction to Case	θ_{JC}	81	°C/W
Operating Ambient Temperature Range	T_A	-40 to +85	°C
Operating Junction Temperature Range	T_J	-40 to +150	°C
Storage Temperature Range	T_{STG}	-65 to +150	°C
Lead Temperature (Soldering) 10 sec	T_{LEAD}	300	°C

Electrical Characteristics⁽¹⁾

Unless specified: $V_{IN} = 3.6V$, $V_{SET} = GND$, $V_{EN} = V_{IN}$, $T_A = 25^\circ C$. Values in **bold** apply over full operating ambient temperature range.

Parameter	Symbol	Test Conditions	Min	Typ	Max	Units
IN						
Supply Voltage Range	V_{IN}		2.5		6.0	V
Supply Current	I_Q	$I_{OUT} = 0mA$		100	130	μA
					160	
		$50mA \leq I_{OUT} \leq 150mA$		110	160	μA
					200	
		$V_{EN} = 0V$		0.0001	1	μA
					2	
OUT						
Output Voltage ⁽²⁾	V_{OUT}	$I_{OUT} = 1mA$	-2.0%	V_{OUT}	+2.0%	V
		$1mA \leq I_{OUT} \leq 150mA, V_{OUT} + 1V \leq V_{IN} \leq 5.5V$	-3.5%		+3.5%	
Line Regulation ⁽²⁾	$REG_{(LINE)}$	$2.5V \leq V_{IN} \leq 5.5V, V_{SET} = V_{OUT}, I_{OUT} = 1mA$		5	10	mV
					12	
Load Regulation ⁽²⁾	$REG_{(LOAD)}$	$I_{OUT} = 0mA \text{ to } 50mA$		-10	-15	mV
					-20	
		$I_{OUT} = 0mA \text{ to } 100mA$		-15	-20	mV
					-25	

POWER MANAGEMENT
Electrical Characteristics (Cont.)⁽¹⁾

Unless specified: $V_{IN} = 3.6V$, $V_{SET} = GND$, $V_{EN} = V_{IN}$, $T_A = 25^\circ C$. Values in **bold** apply over full operating ambient temperature range.

Parameter	Symbol	Test Conditions	Min	Typ	Max	Units
Load Regulation (Cont.) ⁽²⁾	$REG_{(LOAD)}$	$I_{OUT} = 0mA$ to 50mA, $V_{SET} = V_{OUT}$		-2.5	-7.5	mV
					-15.0	
		$I_{OUT} = 0mA$ to 100mA, $V_{SET} = V_{OUT}$		-5	-15	mV
					-30	
Dropout Voltage ⁽²⁾⁽³⁾	V_D	$I_{OUT} = 1mA$		1.1		mV
		$I_{OUT} = 50mA$		55	90	mV
					120	
		$I_{OUT} = 100mA$		110	180	mV
					240	
Current Limit	I_{LM}		150	240	350	mA
Output Voltage Noise	e_n	10Hz to 99kHz, $I_{OUT} = 50mA$, $C_{OUT} = 1\mu F$		90		μV_{RMS}
		10Hz to 99kHz, $I_{OUT} = 50mA$, $C_{OUT} = 100\mu F$		75		
Power Supply Rejection Ratio	PSRR	$f \leq 1kHz$		55		dB
EN						
EN Input Threshold	V_{IH}		1.8			V
	V_{IL}				0.4	
EN Input Bias Current ⁽⁴⁾	I_{EN}	$V_{EN} = V_{IN}$		0	100	nA
					200	
SET						
Sense/Select Threshold	V_{TH}		20	55	80	mV
SET Reference Voltage ⁽²⁾	V_{SET}	$I_{OUT} = 1mA$	1.225	1.250	1.275	V
		$1mA \leq I_{OUT} \leq 150mA$, $2.5V \leq V_{IN} \leq 5.5V$	1.206		1.294	
SET Input Leakage Current ⁽⁴⁾	I_{SET}	$V_{SET} = 1.3V$		0.015	2.500	nA
					5.000	
Over Temperature Protection						
High Trip Level	T_{HI}			170		$^\circ C$
Hysteresis	T_{HYST}			10		$^\circ C$

Notes:

(1) This device is ESD sensitive. Use of standard ESD handling precautions is required.

(2) Low duty cycle pulse testing with Kelvin connections required.

(3) Defined as the input to output differential at which the output voltage drops 100mV below the value measured at a differential of 2V.

(4) Guaranteed by design.

POWER MANAGEMENT

Pin Configuration

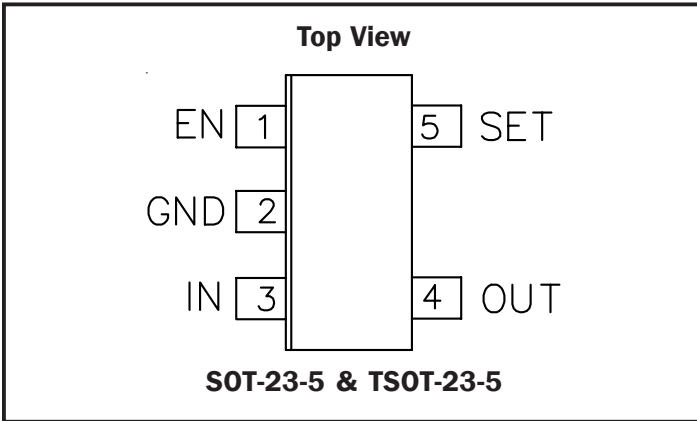

Ordering Information

Part Number	Package
SC8863-XXXCSKTR ⁽¹⁾⁽²⁾	SOT-23-5
SC8863-XXXCSKTRT ⁽¹⁾⁽²⁾⁽³⁾	SOT-23-5
SC8863-XXXTSKTR ⁽¹⁾⁽²⁾	TSOT-23-5
SC8863-XXXEVB ⁽⁴⁾	N/A

Notes:

- (1) Where -XXX denotes voltage options. Available voltages are: 2.50V (-250), 2.80V (-280), 3.00V (-300), and 3.30 (-330)V.
- (2) Only available in tape and reel packaging. A reel contains 3000 devices.
- (3) Lead free product. Fully WEEE and RoHS compliant.
- (4) Evaluation board for SC8863. Specify output voltage option and packaging when ordering.

Block Diagram

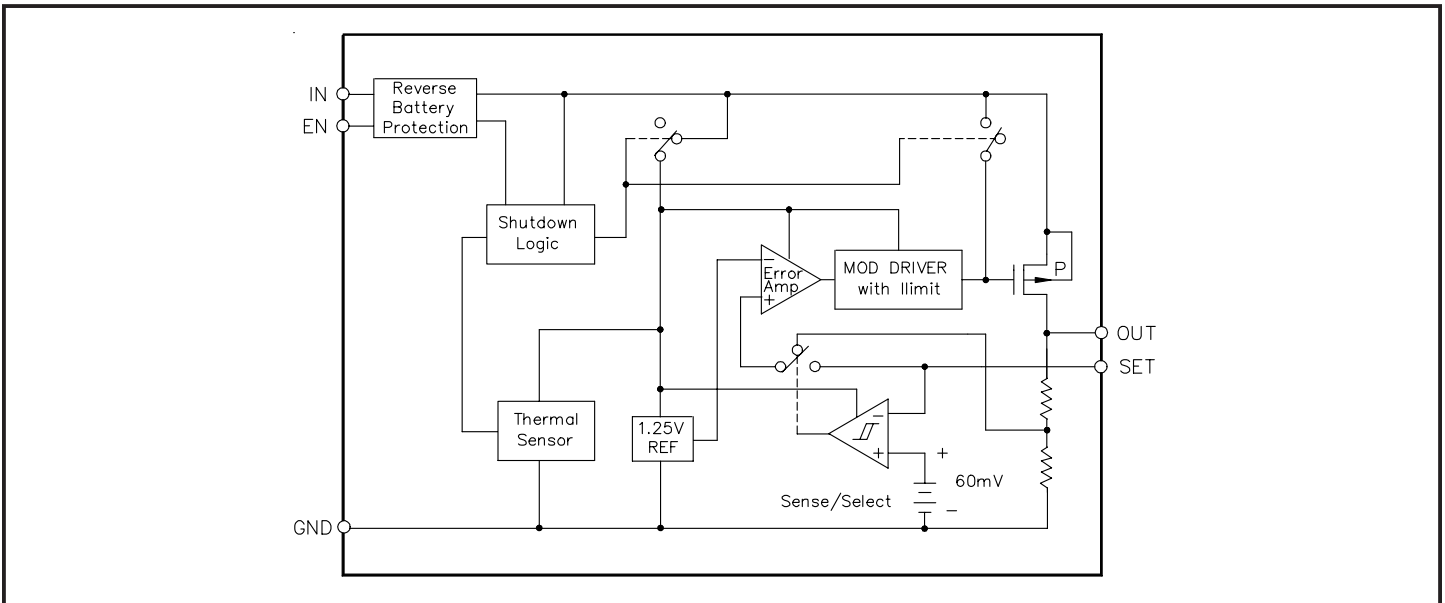

Pin Descriptions

Pin	Pin Name	Pin Function
1	EN	Active high enable pin. Connect to V _{IN} if not being used.
2	GND	Ground pin. Can be used for heatsinking if needed.
3	IN	Input pin.
4	OUT	Regulator output, sourcing up to 150mA.
5	SET	Connecting this pin to ground results in the internally preset value for V _{OUT} . Connecting to an external resistor divider changes V _{OUT} to: $V_{OUT} = 1.250 \cdot \left(1 + \frac{R1}{R2}\right)$

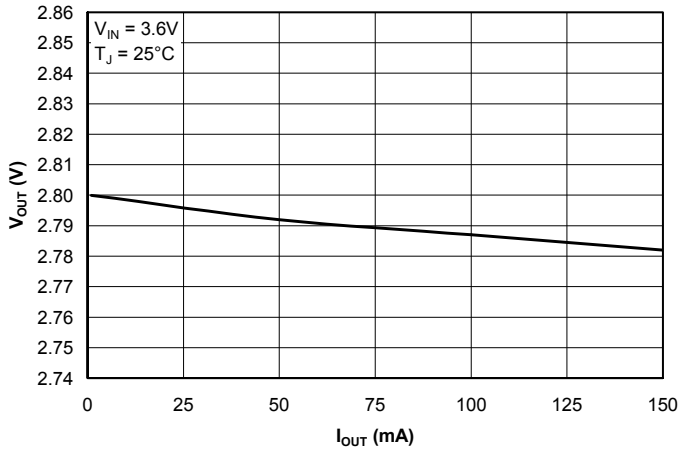
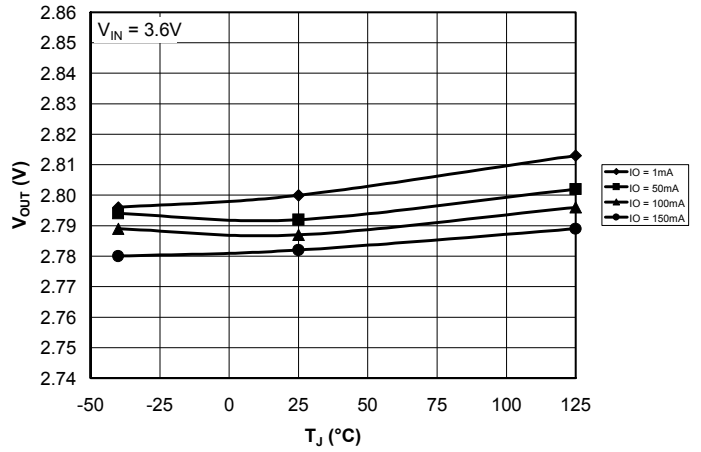
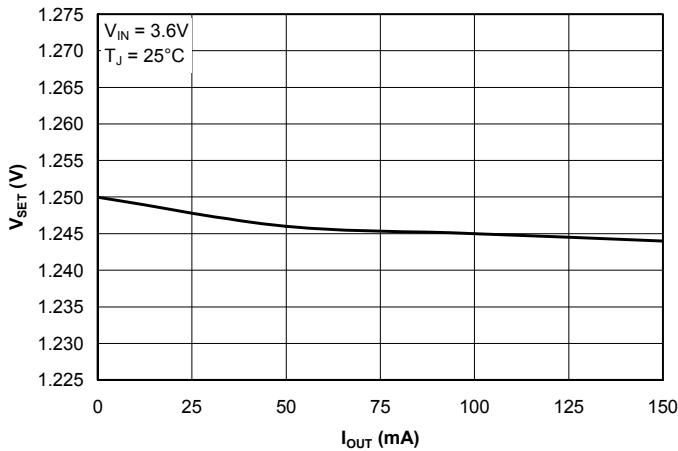
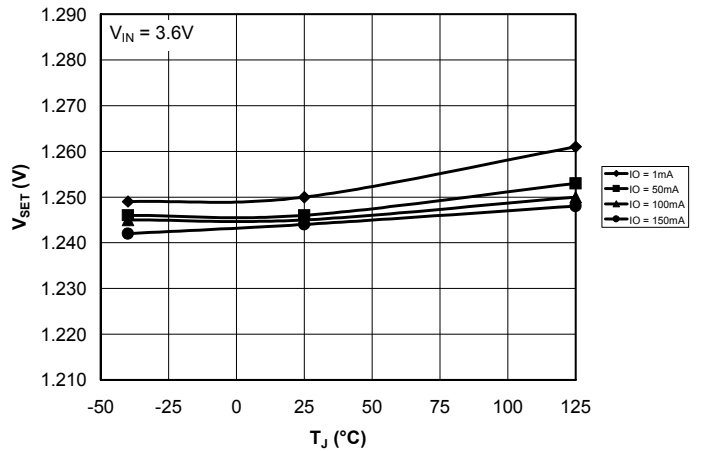
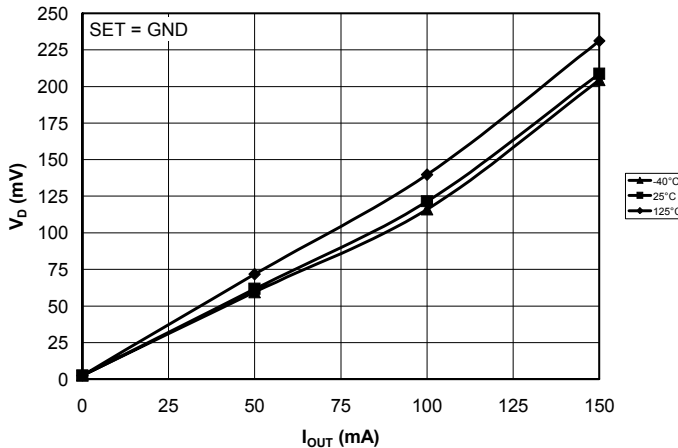
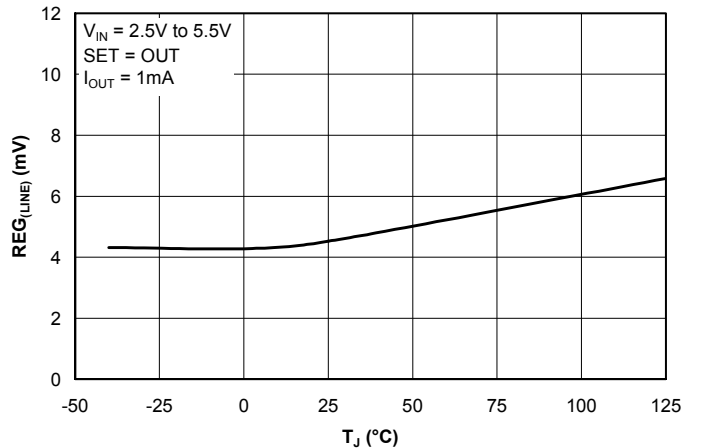
POWER MANAGEMENT
Typical Characteristics
**Output Voltage vs.
Output Current**

**Output Voltage vs. Junction Temperature
vs. Output Current**

**SET Reference Voltage vs.
Output Current**

**SET Reference Voltage vs. Junction
Temperature vs. Output Current**

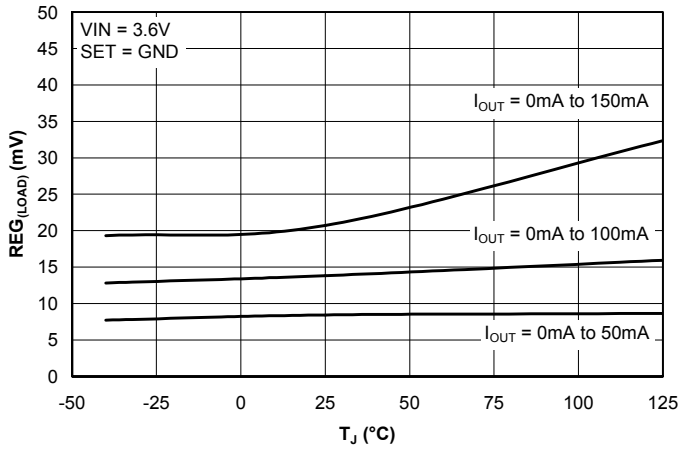
**Dropout Voltage vs. Output Current
vs. Junction Temperature**

**Line Regulation vs.
Junction Temperature**

POWER MANAGEMENT

Typical Characteristics (Cont.)

**Load Regulation ($V_{SET} = GND$)
vs. Junction Temperature**



**Load Regulation ($V_{SET} = V_{OUT}$)
vs. Junction Temperature**

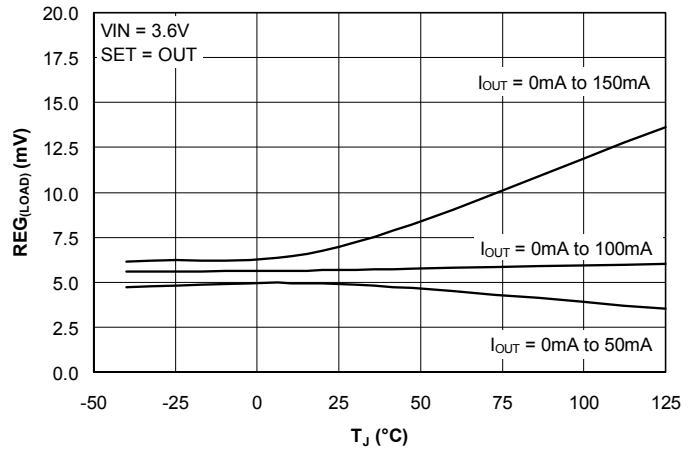

**Supply Current vs.
Output Current**

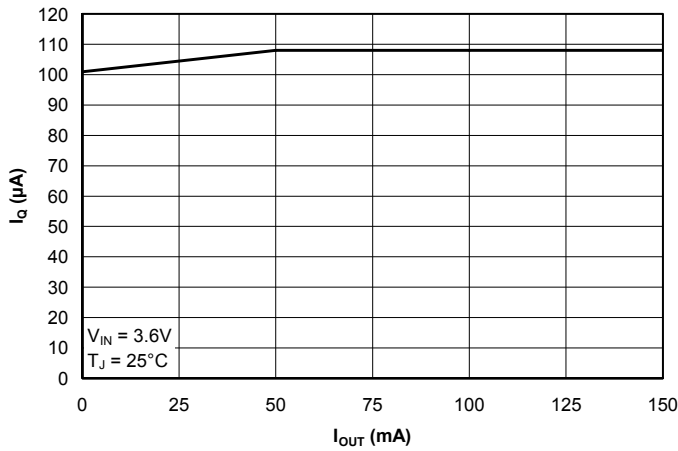

**Supply Current vs.
Junction Temperature**

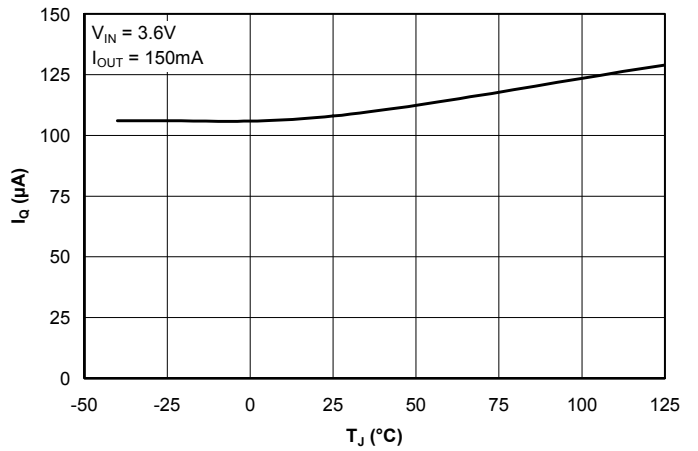

**Current Limit vs.
Junction Temperature**

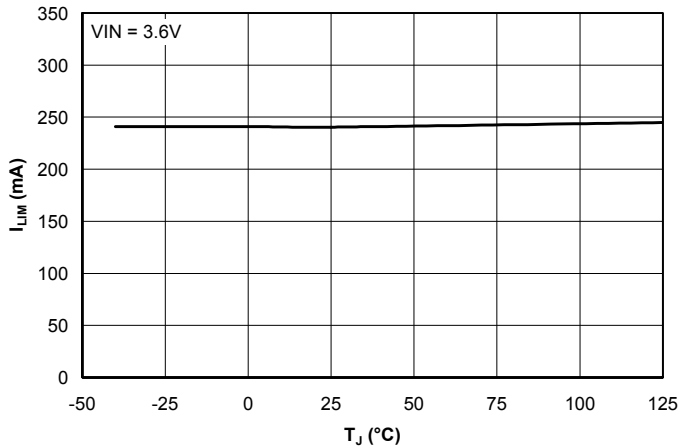

**Enable Input Threshold vs.
Junction Temperature**

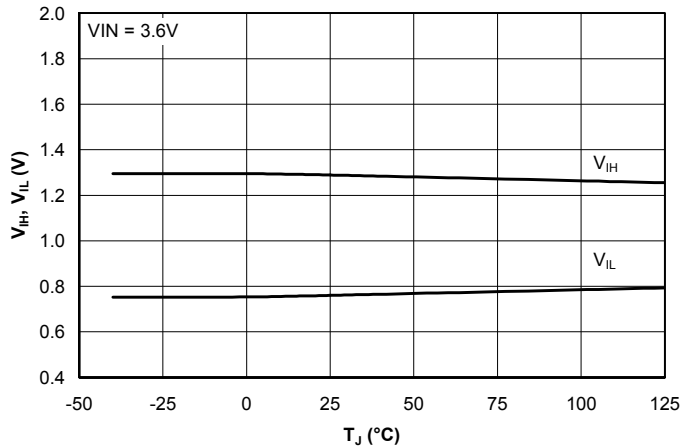

POWER MANAGEMENT

Typical Characteristics (Cont.)

Sense/Select Threshold vs. Junction Temperature

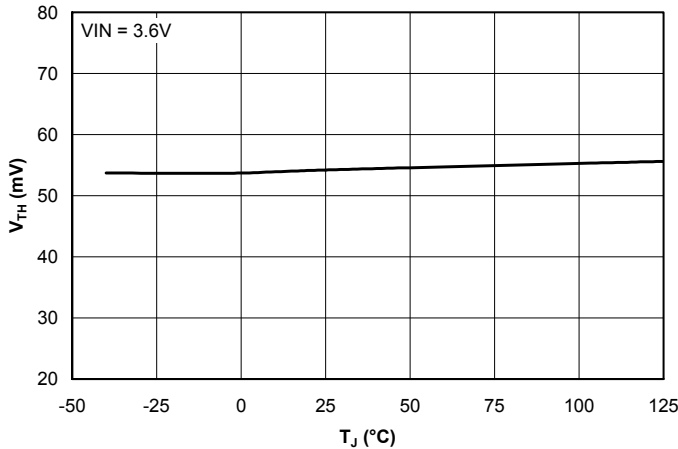

Output Spectral Noise Density vs. Frequency

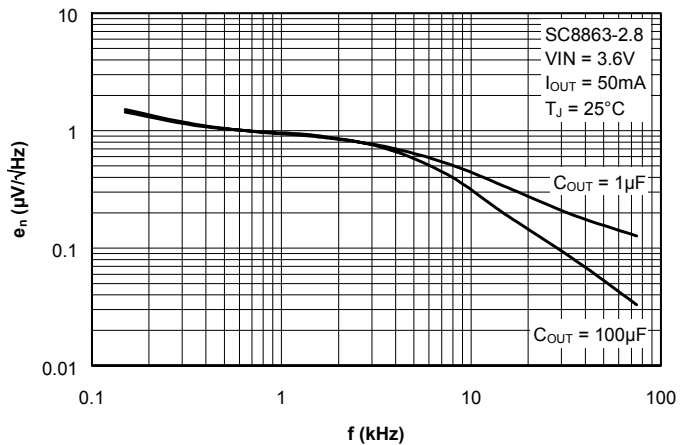

Applications Information

Theory Of Operation

The SC8863 is intended for applications where very low dropout voltage, low supply current and low output noise are critical. It provides a very simple, low cost solution that uses very little pcb real estate. Fixed output voltage options require the use of only two external capacitors for operation.

Each voltage option has both fixed and adjustable output voltage modes. Grounding the SET pin (pulling it below the Sense/Select threshold of 55mV) will connect the internal resistor divider to the error amplifier resulting with the internally preset output voltage. If SET is pulled above this threshold, then the Sense/Select switch will connect the SET pin to the error amplifier. The output will be regulated such that the voltage at SET will equal V_{SET}, the SET reference voltage (typically 1.250V).

An active high enable pin (EN) is provided to allow the customer to shut down the part and enter an extremely low power Off-state. A logic Low signal will reduce the supply current to 0.1nA.

Component Selection - General

Output capacitor: Semtech recommends a minimum capacitance of 1µF at the output with an equivalent series resistance (ESR) of <1Ω over temperature. Ceramic capacitors are ideal for this application. Increasing the bulk capacitance will further reduce

output noise and improve the overall transient response.

Input capacitor: Semtech recommends the use of a 1µF ceramic capacitor at the input. This allows for the device being some distance from any bulk capacitance on the rail. Additionally, input droop due to load transients is reduced, improving load transient response.

Component Selection - Externally Set Output

Please refer to Figure 1 below. The output voltage can be externally adjusted anywhere within the range from 1.25V to (V_{IN(MIN)} - V_{D(MAX)}). The output voltage will be in accordance with the following equation:

$$V_{OUT} = 1.250 \cdot \left(1 + \frac{R1}{R2} \right)$$

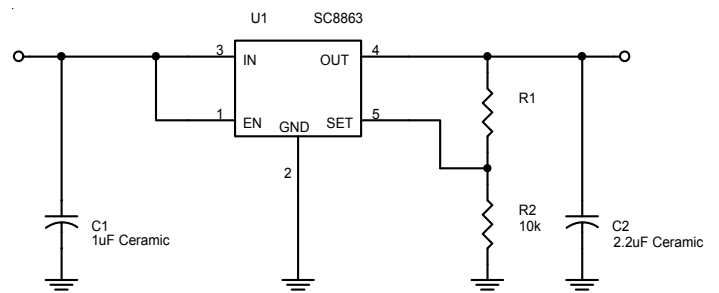

Figure 1: Externally set output

POWER MANAGEMENT
Applications Information (Cont.)

1% tolerance resistors are recommended. The values of R1 and R2 should be selected such that the current flow through them is $\geq 10\mu\text{A}$ (thus $R2 \leq 120\text{k}\Omega$). At high input voltages and/or high output currents, stability may be improved by increasing C2 to $2.2\mu\text{F}$ and reducing R2 to $10\text{k}\Omega$. See “Component Selection - General” for input capacitor requirements.

Thermal Considerations

The worst-case power dissipation for this part is given by:

$$P_{D(\text{MAX})} = (V_{\text{IN}(\text{MAX})} - V_{\text{OUT}(\text{MIN})}) \cdot I_{\text{OUT}(\text{MAX})} + V_{\text{IN}(\text{MAX})} \cdot I_{\text{Q}(\text{MAX})}$$

For all practical purposes, it can be reduced to:

$$P_{D(\text{MAX})} = (V_{\text{IN}(\text{MAX})} - V_{\text{OUT}(\text{MIN})}) \cdot I_{\text{OUT}(\text{MAX})}$$

Looking at a typical application:

$$\begin{aligned} V_{\text{IN}(\text{MAX})} &= 4.2\text{V} \\ V_{\text{OUT}} &= (3 - 3.5\%) = 2.895\text{V worst-case} \\ I_{\text{OUT}} &= 150\text{mA} \\ T_{\text{A}} &= 85^\circ\text{C} \end{aligned}$$

This gives us:

$$P_{D(\text{MAX})} = (4.2 - 2.895) \cdot 0.150 = 196\text{mW}$$

Using this figure, we can calculate the maximum thermal impedance allowable to maintain $T_{\text{J}} \leq 150^\circ\text{C}$:

$$\theta_{(\text{J-A})\text{(MAX)}} = \frac{(T_{\text{J}(\text{MAX})} - T_{\text{A}(\text{MAX})})}{P_{D(\text{MAX})}} = \frac{(150 - 85)}{0.196} = 332^\circ\text{C/W}$$

With the standard SOT-23-5/TSOT-23-5 Land Pattern shown at the end of this datasheet, and minimum trace widths, the thermal impedance junction to ambient for SC8863 is 256°C/W . Thus with no additional heatsinking, $T_{\text{J}(\text{MAX})} = 135^\circ\text{C}$.

The junction temperature can be reduced further by the use of larger trace widths, and connecting pcb copper area to the GND pin (pin 2), which connects directly to the device substrate. Adding approximately one square inch of pcb copper to pin 2 will reduce $\theta_{\text{TH}(\text{J-A})}$ to approximately 130°C/W and $T_{\text{J}(\text{MAX})}$ to approximately 110°C , for example. Lower junction temperatures improve overall output voltage accuracy. A sample pcb layout for the Internally Preset Output Voltage circuit on page 1 is shown in Figure 2 on page 9.

Layout Considerations

While layout for linear devices is generally not as critical as for a switching application, careful attention to detail will ensure reliable operation. See Figure 2 on page 9 for a sample layout.

- 1) Attaching the part to a larger copper footprint will enable better heat transfer from the device, especially on PCBs where there are internal ground and power planes.
- 2) Place the input and output capacitors close to the device for optimal transient response and device behavior.
- 3) Connect all ground connections directly to the ground plane. If there is no ground plane, connect to a common local ground point before connecting to board ground.

POWER MANAGEMENT

Applications Information (Cont.)

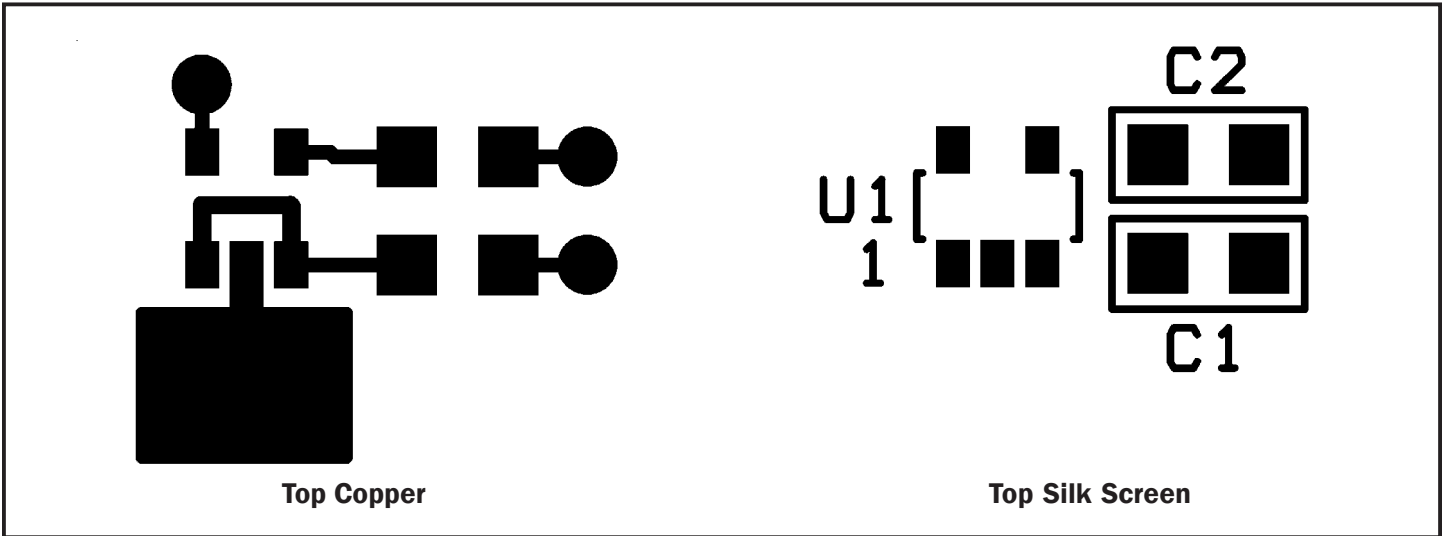
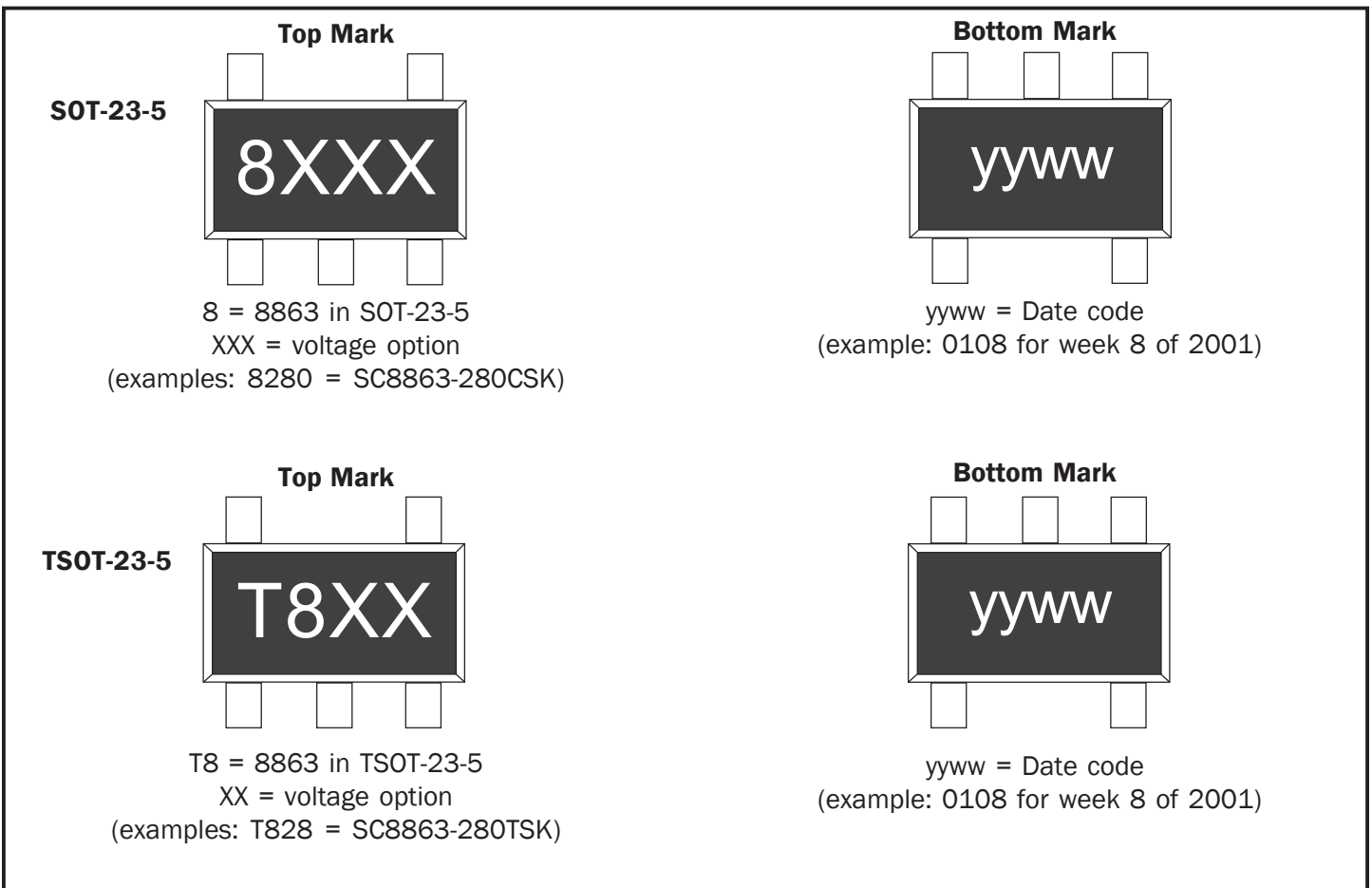

Figure 2: Suggested pcb layout based upon internally preset output voltage application on page 1.

Notes:

- (1) All vias go to the ground plane.
- (2) Copper area on pin 2 is recommended, but not required. Connect to the ground plane with a via or vias.

Marking Information



POWER MANAGEMENT

Outline Drawing - SOT-23-5

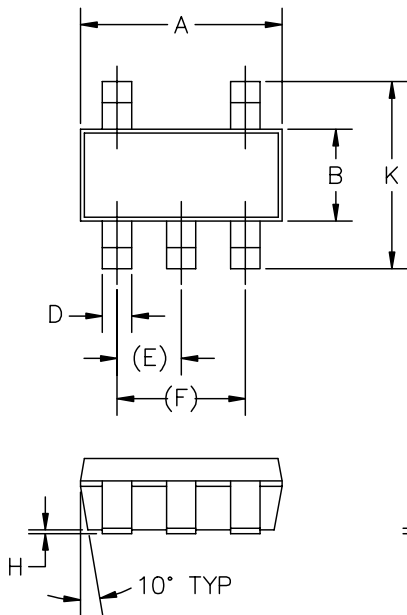

DIM ^N	INCHES		MM		NOTE
	MIN	MAX	MIN	MAX	
A	.110	.120	2.80	3.05	—
B	.059	.070	1.50	1.75	—
C	.036	.051	.90	1.30	—
D	.014	.020	.35	.50	—
E	—	.037	—	0.95	REF
F	—	.075	—	1.90	REF
H	—	.006	—	.150	—
J	.0035	.008	.090	.20	—
K	.102	.118	2.6	3.00	—

① CONTROLLING DIMENSIONS: MILLIMETERS.

Outline Drawing - TSOT-23-5

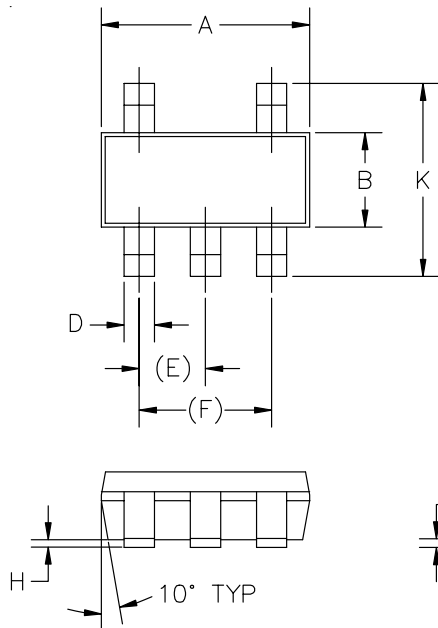

DIM ^N	INCHES		MM		NOTE
	MIN	MAX	MIN	MAX	
A	.110	.120	2.80	3.05	—
B	.059	.070	1.50	1.75	—
C	.033	.036	0.84	0.90	—
D	.012	.018	0.30	0.45	—
E	—	.037	—	0.95	REF
F	—	.075	—	1.90	REF
H	.0004	.004	0.01	0.10	—
J	.0047	.008	0.12	0.20	—
K	.102	.118	2.6	3.00	—

② PACKAGE OUTLINE EXCLUSIVE OF MOLD FLASH AND METAL BURR.

① CONTROLLING DIMENSIONS: MILLIMETERS.

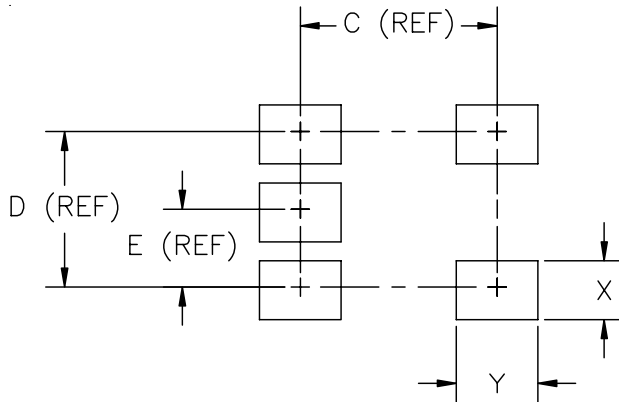
POWER MANAGEMENT
Land Pattern - SOT-23-5 & TSOT-23-5

DIMENSIONS			
DIM ^N	INCHES	MM	NOTE
C	.094	2.4	-
D	.074	1.9	-
E	.037	.95	-
X	.028	.7	-
Y	.039	1.0	-

Contact Information

Semtech Corporation
 Power Management Products Division
 200 Flynn Road, Camarillo, CA 93012
 Phone: (805)498-2111 FAX (805)498-3804