

# SG2012

# 400mA , Low Power, Low Dropout, Linear Regulators

## GENERAL DESCRIPTION

The SG2012 low-power, low-dropout, CMOS linear voltage regulators operate from a 2.5V to 5.5V input and deliver up to 400mA. They are perfect choice for low voltage, low power applications. An ultra low ground current (120µA at 400mA output) makes them attractive for battery operated power systems. The SG2012 series also offer ultra low dropout voltage (280mV at 400mA output) to prolong battery life in portable electronics.

The output voltage is preset to voltages in the range of 1.5V to 4.5V. Other features include foldback current limit and thermal shut-down protection.

SG2012 comes in 3-pin SOT223 package.

## APPLICATIONS

Cellular Telephones  
 Digital Cameras  
 MP3、MP4  
 USB 2.0  
 Modems  
 PC Cameras  
 Hand-Held Instruments  
 Electronic Dictionaries  
 Portable/Battery-Powered Equipment

## TYPICAL OPERATION CIRCUIT

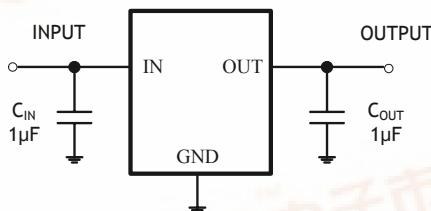

## FEATURES

- Ultra-Low Dropout Voltage:  
280mV at 400mA output
- Low 80µA No-Load Supply Current
- Low 120µA Operating Supply Current at 400mA Output
- Thermal-Overload Protection
- Output Current Limit
- Preset Output Voltages (±1.8% Accuracy)
- Output Voltage:  
Available in Fixed Outputs of 1.5V, 1.8V, 2.5V, 2.8V, 3.0V, and 3.3V

## PIN CONFIGURATIONS (TOP VIEW)

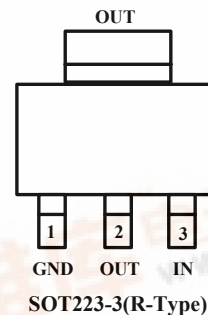
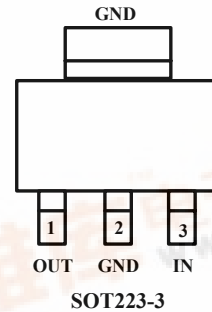

## ORDERING INFORMATION

MODEL	V <sub>OUT</sub> (V)	PIN-PACKAGE	SPECIFIED TEMPERATURE RANGE	ORDERING NUMBER	PACKAGE MARKING	PACKAGE OPTION
SG2012-1.5	1.5V	SOT223-3	- 40°C to +125°C	SG2012-1.5XKC3/TR	SG2012-1.5XKC3	Tape and Reel, 2500
		SOT223-3(R-Type)		SG2012-1.5XKC3R/TR	SG2012-1.5XKC3R	
SG2012-1.8	1.8V	SOT223-3	- 40°C to +125°C	SG2012-1.8XKC3/TR	SG2012-1.8XKC3	Tape and Reel, 2500
		SOT223-3(R-Type)		SG2012-1.8XKC3R/TR	SG2012-1.8XKC3R	
SG2012-2.5	2.5V	SOT223-3	- 40°C to +125°C	SG2012-2.5XKC3/TR	SG2012-2.5XKC3	Tape and Reel, 2500
		SOT223-3(R-Type)		SG2012-2.5XKC3R/TR	SG2012-2.5XKC3R	
SG2012-2.8	2.8V	SOT223-3	- 40°C to +125°C	SG2012-2.8XKC3/TR	SG2012-2.8XKC3	Tape and Reel, 2500
		SOT223-3(R-Type)		SG2012-2.8XKC3R/TR	SG2012-2.8XKC3R	
SG2012-3.0	3.0V	SOT223-3	- 40°C to +125°C	SG2012-3.0XKC3/TR	SG2012-3.0XKC3	Tape and Reel, 2500
		SOT223-3(R-Type)		SG2012-3.0XKC3R/TR	SG2012-3.0XKC3R	
SG2012-3.3	3.3V	SOT223-3	- 40°C to +125°C	SG2012-3.3XKC3/TR	SG2012-3.3XKC3	Tape and Reel, 2500
		SOT223-3(R-Type)		SG2012-3.3XKC3R/TR	SG2012-3.3XKC3R	

## ABSOLUTE MAXIMUM RATINGS

IN to GND.....- 0.3V to +6V  
 Output Short-Circuit Duration.....Infinite  
 OUT to GND.....- 0.3V to (V<sub>IN</sub> + 0.3V)  
 Operating Temperature Range.....- 40°C to +125°C  
 Junction Temperature.....+150°C  
 Storage Temperature.....- 65°C to +150°C  
 Power Dissipation, P<sub>D</sub> @ T<sub>A</sub> = 25°C

SOT223-3.....0.74W  
 Package Thermal Resistance  
 SOT223-3, θ<sub>JA</sub>.....135°C/W  
 Lead Temperature (soldering, 10s) .....+260°C  
 ESD Susceptibility  
 HBM.....7000V  
 MM.....400V

Stresses beyond those listed under “Absolute Maximum Ratings” may cause permanent damage to the device. These are stress ratings only, and functional operation of the device at these or any other conditions beyond those indicated in the operational sections of the specifications is not implied. Exposure to absolute maximum rating conditions for extended periods may affect device reliability.

## PIN DESCRIPTION

NAME	FUNCTION
IN	Regulator Input. Supply voltage can range from 2.5V to 5.5V.
GND	Ground.
OUT	Regulator Output.

# ELECTRICAL CHARACTERISTICS

( $V_{IN} = V_{OUT(NOMINAL)} + 1V$ ,  $T_A = -40^{\circ}C$  to  $+125^{\circ}C$ , unless otherwise noted. Typical values are at  $T_A = +25^{\circ}C$ .)

PARAMETER	SYMBOL	CONDITIONS	MIN	TYP	MAX	UNITS
Input Voltage	$V_{IN}$		2.5		5.5	V
Output Voltage Accuracy		$I_{OUT} = 0.1mA$ , $T_A = +25^{\circ}C$	-1.8		1.8	%
		$I_{OUT} = 0.1mA$ to $400mA$ , $T_A = 0^{\circ}C$ to $+70^{\circ}C$			2.6	
		$I_{OUT} = 0.1mA$ to $400mA$ , $T_A = -40^{\circ}C$ to $+125^{\circ}C$			3.1	
Output Current			400			mA
Current Limit	$I_{LIM}$		410	750		mA
Ground Pin Current	$I_Q$	No load		80	130	$\mu A$
		$I_{OUT} = 400mA$		120		
Dropout Voltage(Note1)		$I_{OUT} = 1mA$		0.8		mV
		$I_{OUT} = 400mA$		280	440	
Line Regulation	$\Delta V_{LNR}$	$V_{IN} = 2.5V$ or $(V_{OUT} + 0.1V)$ to $5.5V$ , $I_{OUT} = 1mA$		0.004	0.15	%/V
Load Regulation	$\Delta V_{LDR}$	$I_{OUT} = 0.1mA$ to $400mA$ , $C_{OUT} = 1\mu F$		0.0005	0.002	%/mA
Output Voltage Noise	$e_n$	$f = 10Hz$ to $100KHz$ , $C_{OUT} = 10\mu F$		120		$\mu VRMS$
Power Supply Rejection Rate	PSRR	$I_{LOAD} = 50mA$ , $C_{OUT} = 1\mu F$	$f = 100Hz$ ,	74		dB
			$f = 1KHz$ ,	54		dB
<b>THERMAL PROTECTION</b>						
Thermal Shutdown Temperature	$T_{SHDN}$			160		$^{\circ}C$
Thermal Shutdown Hysteresis	$\Delta T_{SHDN}$			15		$^{\circ}C$

Specifications subject to change without notice.

**Note 1:** The dropout voltage is defined as  $V_{IN} - V_{OUT}$ , when  $V_{OUT}$  is 100mV below the value of  $V_{OUT}$  for  $V_{IN} = V_{OUT} + 1V$ . (Only applicable for  $V_{OUT} = +2.5V$  to  $+4.5V$ )

# TYPICAL OPERATING CHARACTERISTICS

$V_{IN} = V_{OUT(NOMINAL)} + 1V$ ,  $C_{IN} = 1\mu F$ ,  $C_{OUT} = 1\mu F$ ,  $T_A = +25^\circ C$ , unless otherwise noted.

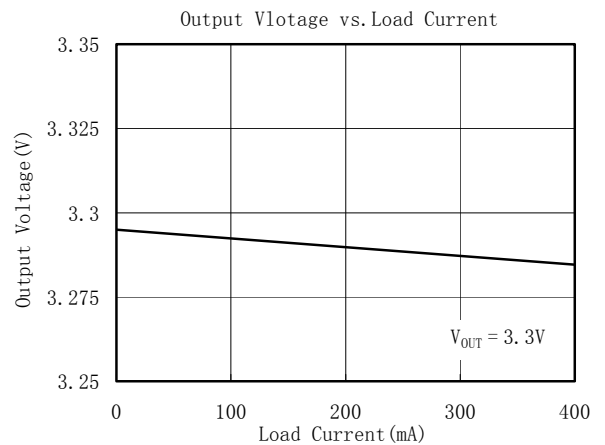
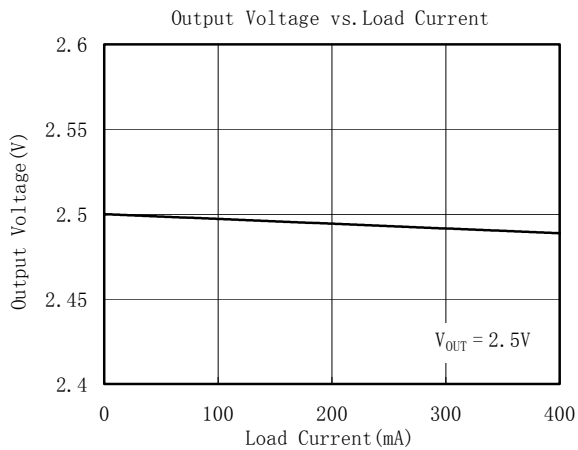
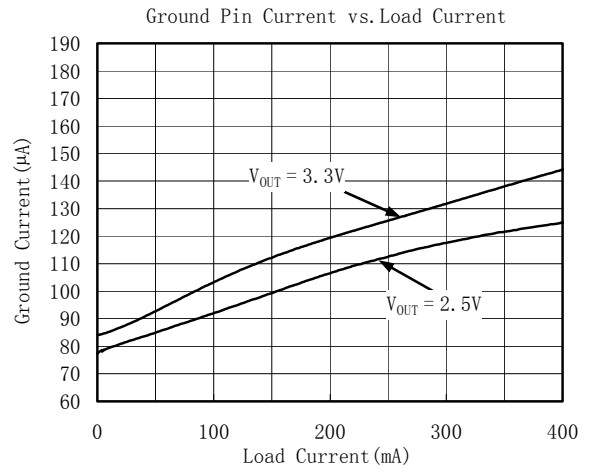
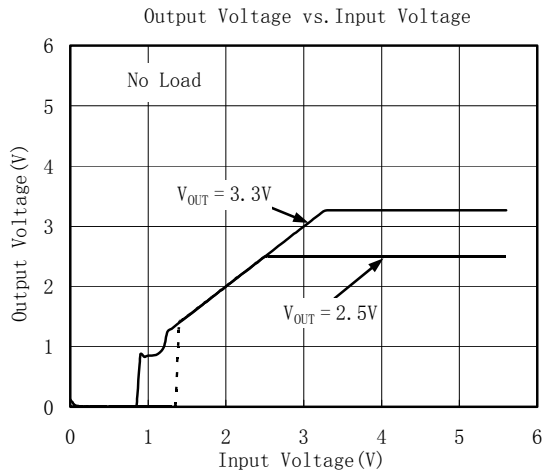
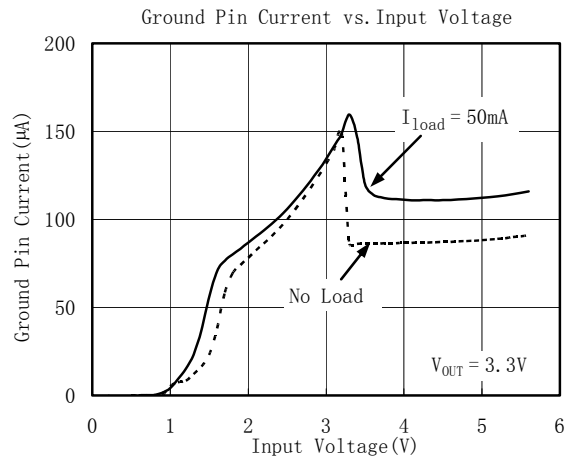
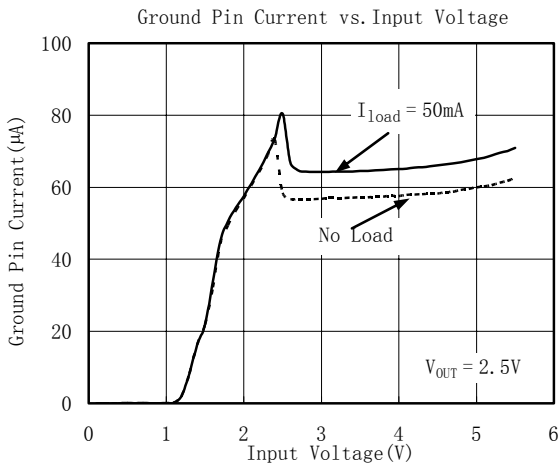

# TYPICAL OPERATING CHARACTERISTICS

$V_{IN} = V_{OUT(NOMINAL)} + 1V$ ,  $C_{IN} = 1\mu F$ ,  $C_{OUT} = 1\mu F$ ,  $T_A = +25^\circ C$ , unless otherwise noted.

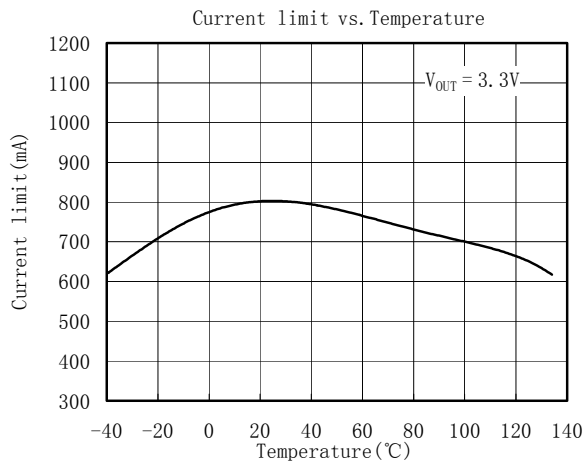
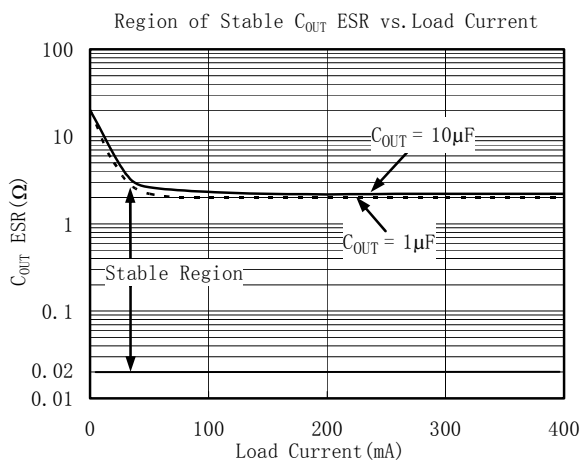
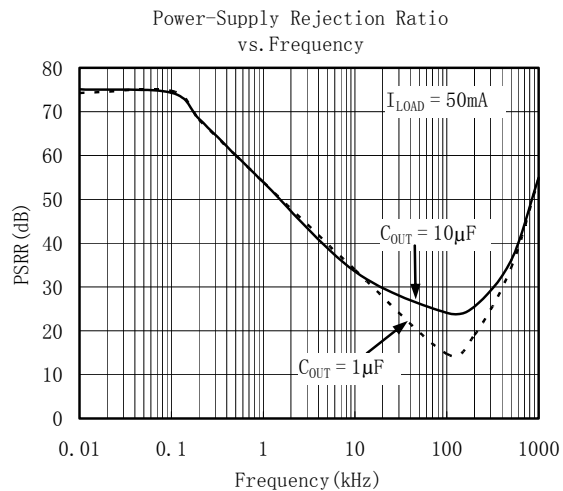
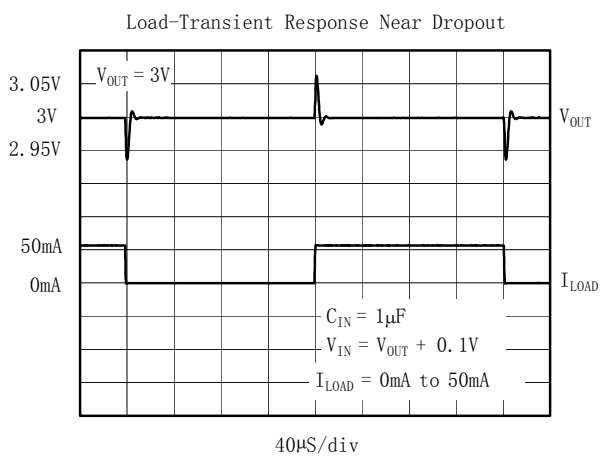
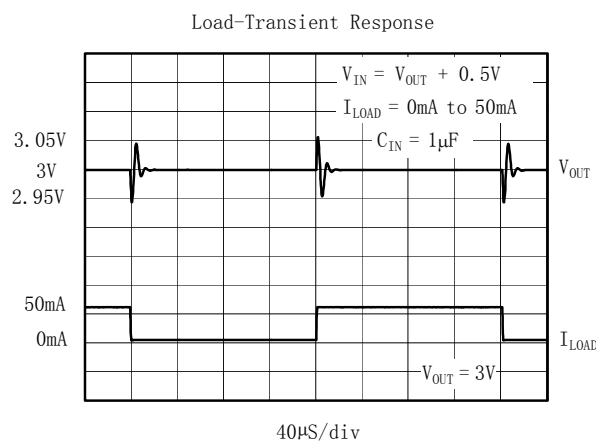
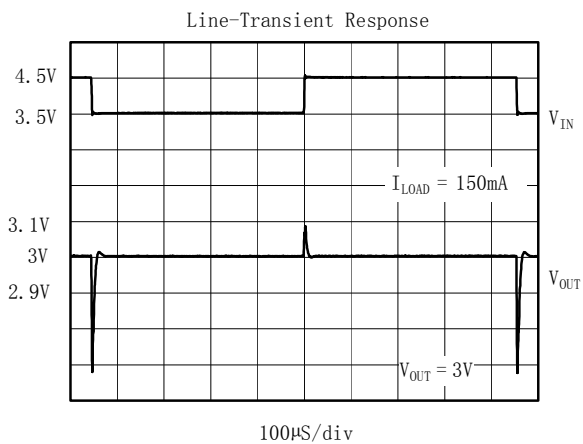

# TYPICAL OPERATING CHARACTERISTICS

$V_{IN} = V_{OUT(NOMINAL)} + 1V$ ,  $C_{IN} = 1\mu F$ ,  $C_{OUT} = 1\mu F$ ,  $T_A = +25^\circ C$ , unless otherwise noted.

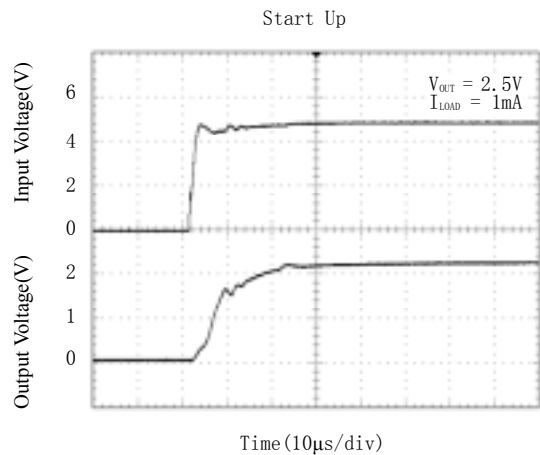
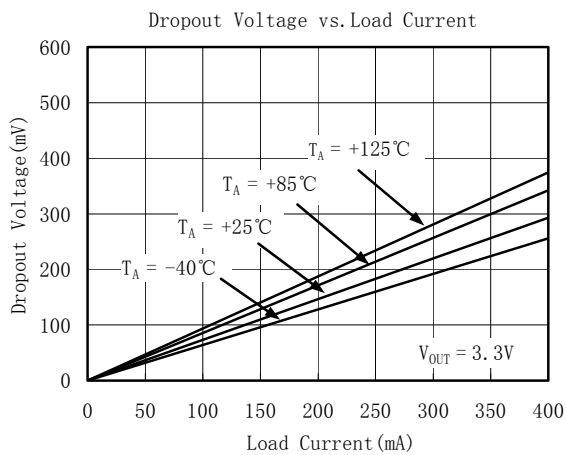
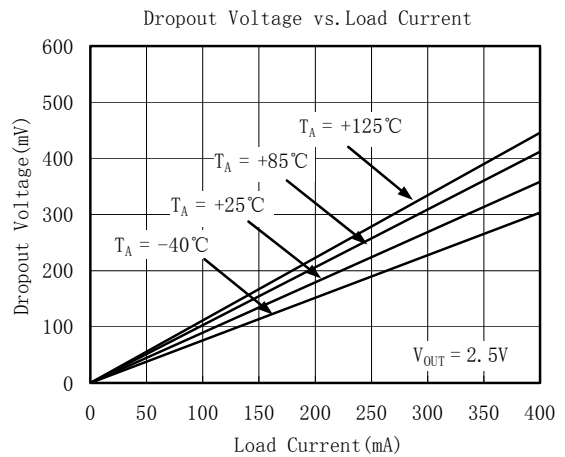
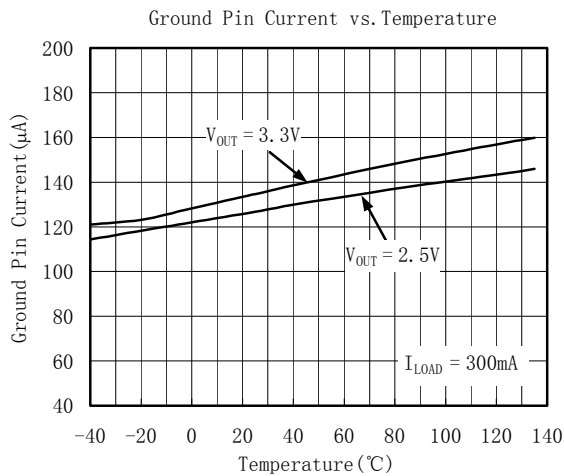
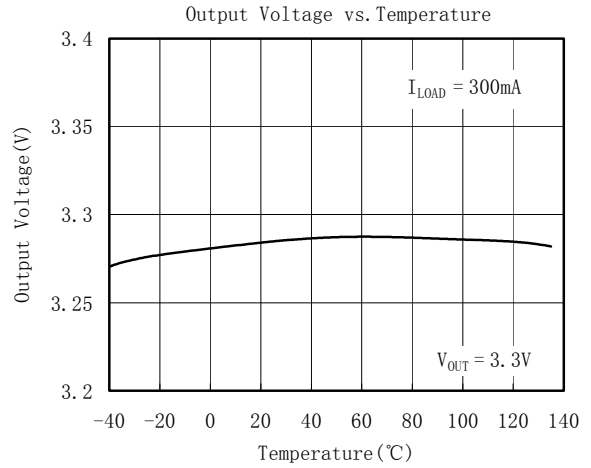
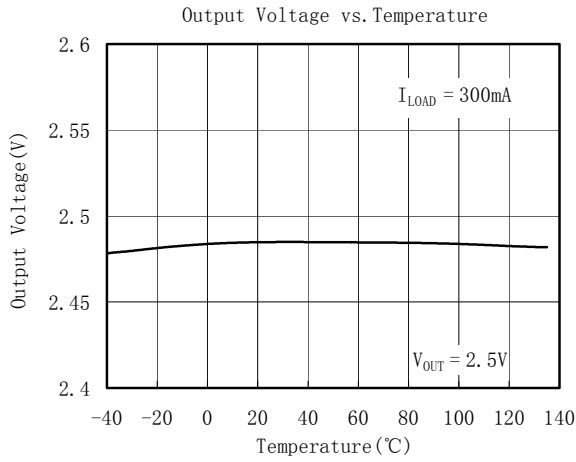

## Application Notes

When LDO is used in handheld products, Attention must be paid to voltage spike which would damage SG2012. In such applications, voltage spike will be generated at charger interface and  $V_{BUS}$  pin of USB interface when charger adapters and USB equipments are hot-inserted. Besides this, handheld products will be tested on the production line on the condition of no battery. Test Engineer will apply power from the connector pin which connects with positive pole of the battery. When external power supply is turned on suddenly, the voltage spike will be generated at the battery connector. The voltage spike will be very high, it always exceeds the absolute maximum input voltage (6.0V) of LDO. In order to get robust design. Design Engineer needs to clear up this voltage spike. Zener diode is a cheap and effective solution to eliminate such voltage spike. For example, BZM55B5V6 is a 5.6V small package Zener diode which can be used to remove voltage spike in cell phone design. The schematic is shown in below:

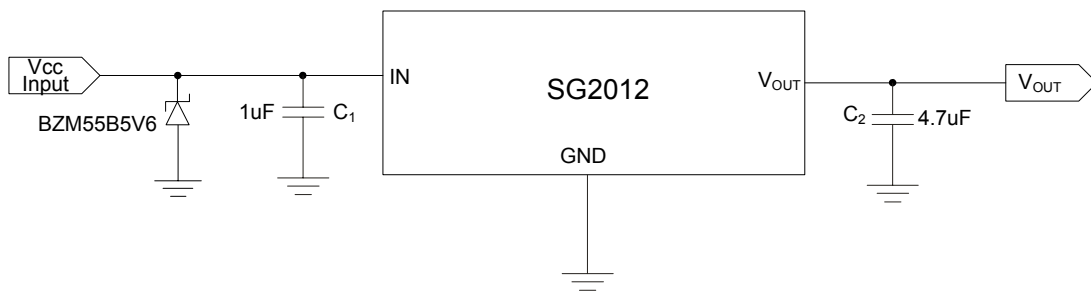

# PACKAGE OUTLINE DIMENSIONS

## SOT223-3

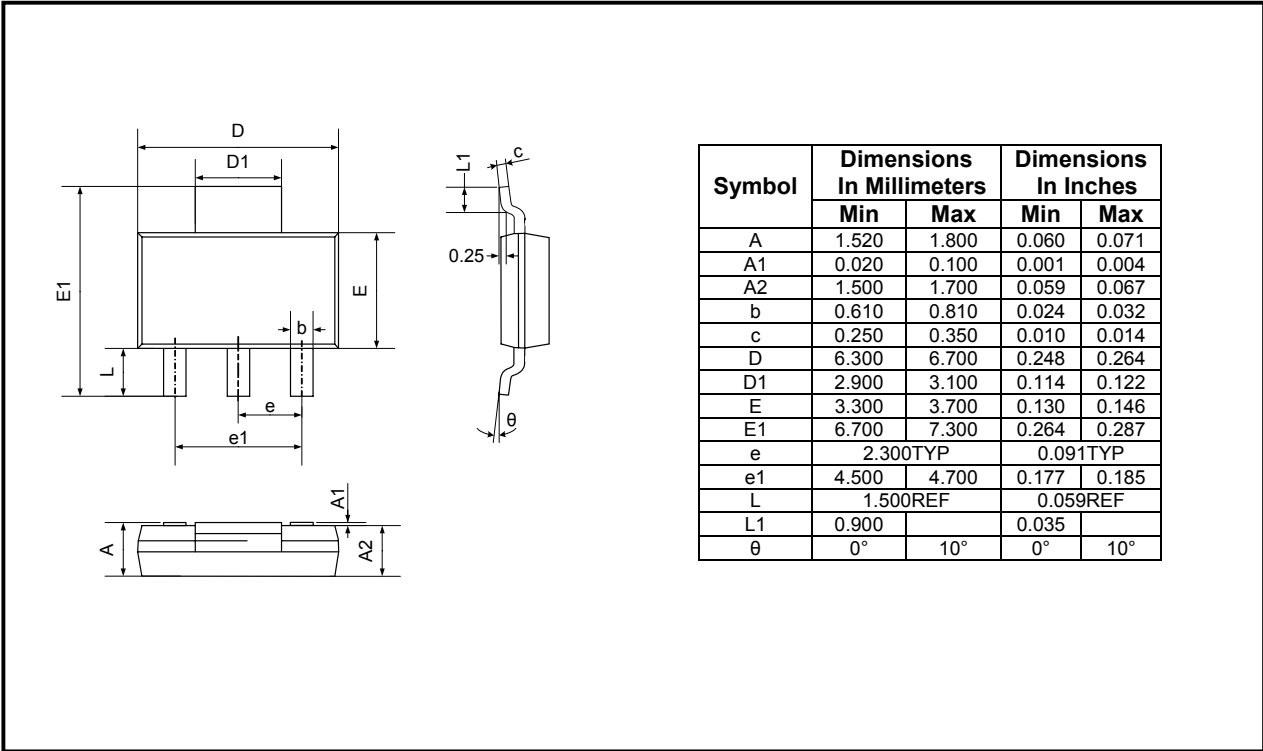



## REVISION HISTORY

Location	Page
<b>9/05— Data Sheet changed from preliminary to REV. A</b>	
<b>12/06— Data Sheet changed from REV. A to REV. B</b>	
Changed to ABSOLUTE MAXIMUM RATINGS .....	2
Added Application Notes .....	7

### Shengbang Microelectronics Co, Ltd

Unit 3, ChuangYe Plaza  
No.5, TaiHu Northern Street, YingBin Road Centralized Industrial Park  
Harbin Development Zone  
Harbin, HeiLongJiang 150078  
P.R. China  
Tel.: 86-451-84348461  
Fax: 86-451-84308461  
[www.sg-micro.com](http://www.sg-micro.com)