



HMC278MS8G

100 mW MEDIUM POWER GaAs IC AMPLIFIER 1.7 - 3.0 GHz

FEBRUARY 2001

v01.1200

Features

P1dB OUTPUT POWER: + 20 dBm

SINGLE SUPPLY: +3V to +5V

ULTRA SMALL 8 LEAD MSOP PACKAGE

IDEAL FOR PCS/3G, MMDS, HomeRF, & BLUETOOTH



General Description

The HMC278MS8G is a 100mW GaAs MMIC medium power amplifier covering 1.7 to 3 GHz. The device is packaged in a low cost, surface mount 8 lead MSOP plastic package with an exposed base paddle for improved RF ground and thermal dissipation. The self-biased amplifier provides 21 dB of gain and +20 dBm P1dB output power while operating from a single positive supply of Vdd= +5V @ 130 mA. At Vdd = +3V the gain is 19 dB with a P1dB of +16dBm. With RF I/Os matched to 50Ω, external component requirements are minimal. At a height of 0.040" (1.0mm), the MSOP8 package is ideal for low profile portable wireless devices. Use the HMC278MS8G with the HMC309MS8 integrated LNA/TxRx switch front-end for BLUETOOTH Class I, HomeRF, 802.11 WLAN, and ISM 2.4 GHz radios.

1

AMPLIFIERS

SMT

Guaranteed Performance, As a Function of Vdd, -40 to +85 deg C

Parameter	Vdd= +5V			Vdd= +5V			Vdd= +3V			Units
	Min.	Typ.	Max.	Min.	Typ.	Max.	Min.	Typ.	Max.	
Frequency Range	1.7 - 3.0			2.3 - 2.5			2.3 - 2.5			GHz
Gain	15	20	25	16	21	25	15	19	23	dB
Gain Flatness (Over Any 200 MHz BW)		± 0.7			± 0.5			± 0.5		dB
Input Return Loss	5	10		7	10		7	10		dB
Output Return Loss	6	10		7	10		7	10		dB
Reverse Isolation	46	52		48	52		48	52		dB
Output Power for 1dB Compression (P1dB)	14	19		17	20		13	16		dBm
Saturated Output Power (Psat)	16	21		19	22		15	18		dBm
Output Third Order Intercept (IP3)	26	32		29	32		28	32		dBm
Noise Figure		6			6			6		dB
Supply Voltage (Vdd)	4.75	5.0	5.25	4.75	5.0	5.25	2.75	3.0	3.25	Vdc
Supply Current (Idd)		130	165		130	165		125	140	mA

100 mW MEDIUM POWER GaAs IC AMPLIFIER 1.7 - 3.0 GHz

v01.1200

FEBRUARY 2001

Broadband Gain & Return Loss @ Vdd = +5V

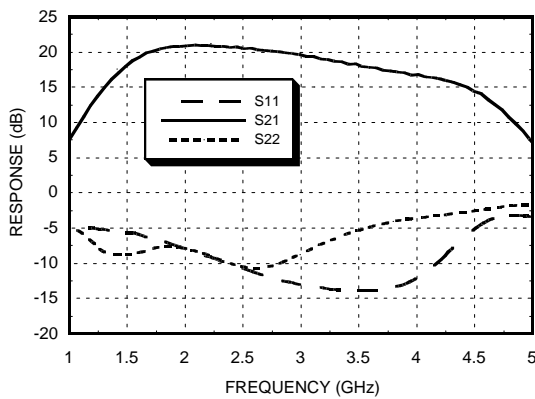

P1dB vs. Vdd Bias

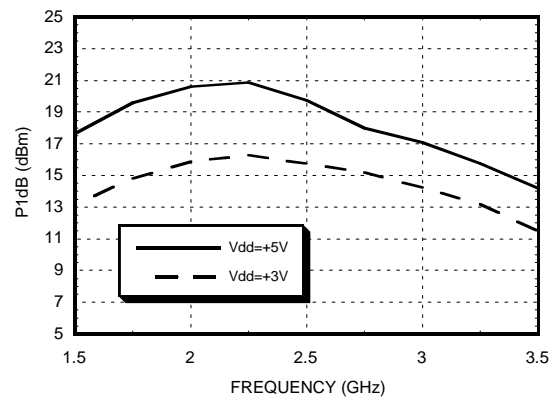

Gain vs. Temperature @ Vdd = +5V

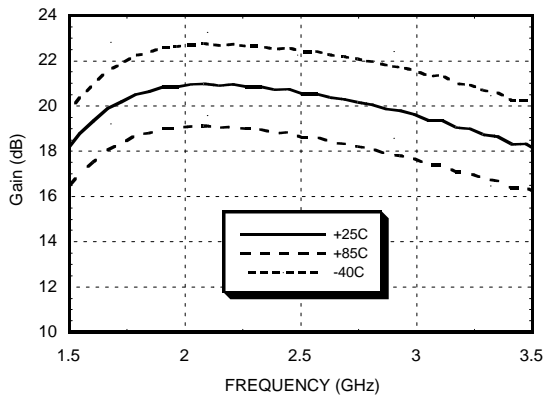

Gain vs. Temperature @ Vdd = +3V

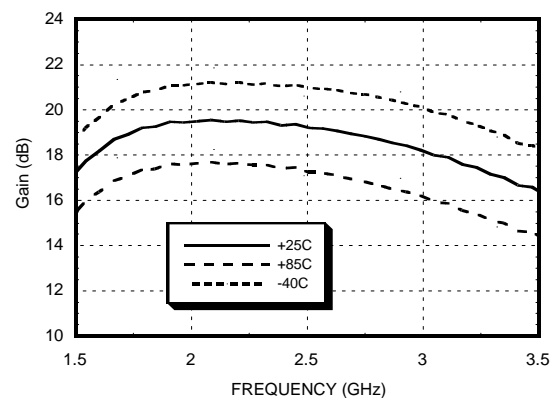

Input & Output Return Loss vs Vdd Bias

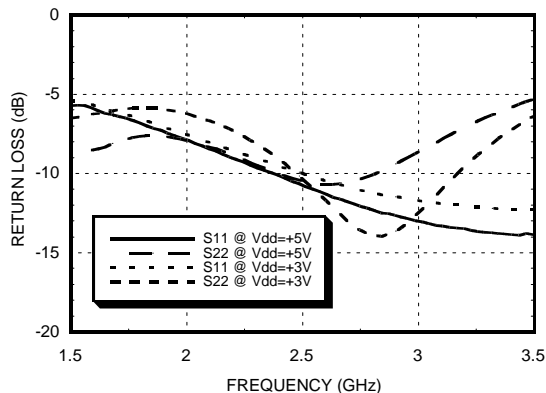

Reverse Isolation vs Vdd Bias

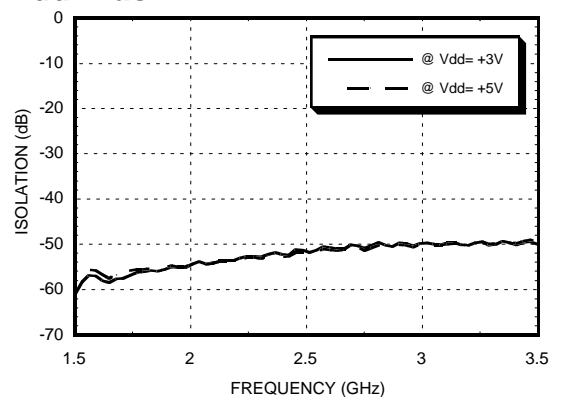

1
AMPLIFIERS
SMT



100 mW MEDIUM POWER GaAs IC AMPLIFIER 1.7 - 3.0 GHz

FEBRUARY 2001

v01.1200

Power Compression @ 2.0 GHz
Vdd= +5V

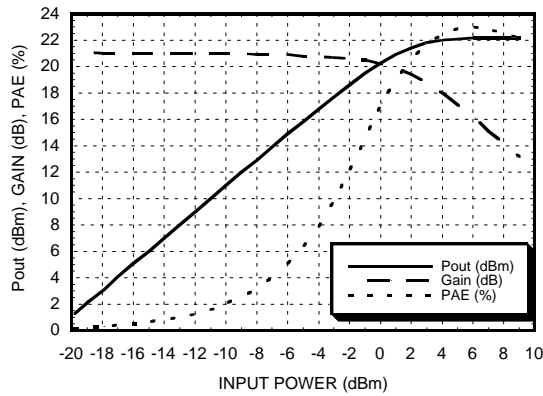

Power Compression @ 2.5 GHz
Vdd= +5V

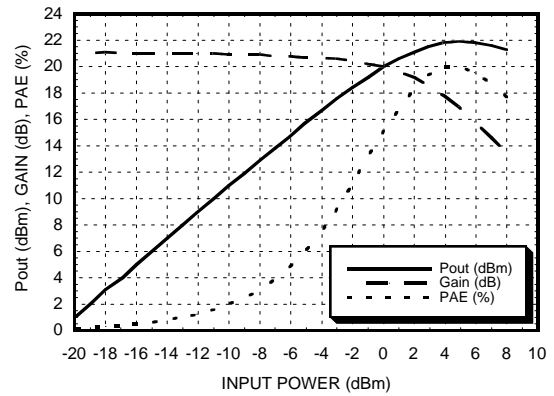

Psat vs. Temperature
@ Vdd= +5V

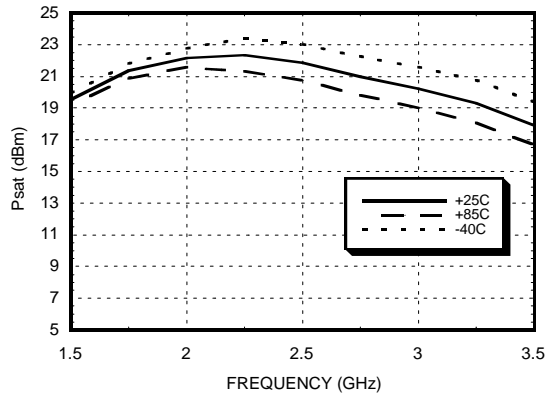

P1dB vs. Temperature
@ Vdd= +5V

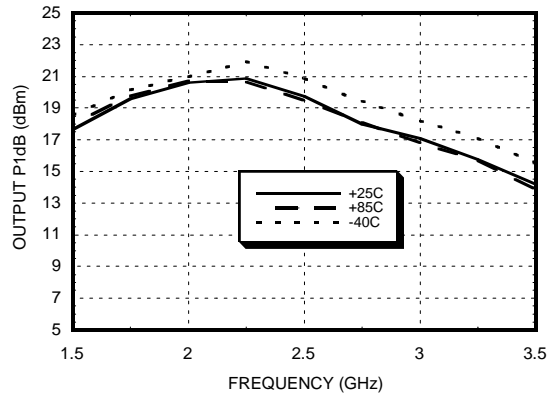

Output IP3 vs. Temperature
@ Vdd= +5V

	Frequency (GHz)		
Temperature	2.0	2.5	3.0
-40 °C	32.7	32.4	29.4
+25 °C	32.5	31.9	29.1
+85 °C	32.7	31.4	28.5

All levels in dBm

1 AMPLIFIERS SMT

100 mW MEDIUM POWER GaAs IC AMPLIFIER 1.7 - 3.0 GHz

v01.1200

FEBRUARY 2001

Power Compression @ 2.0 GHz
Vdd= +3V

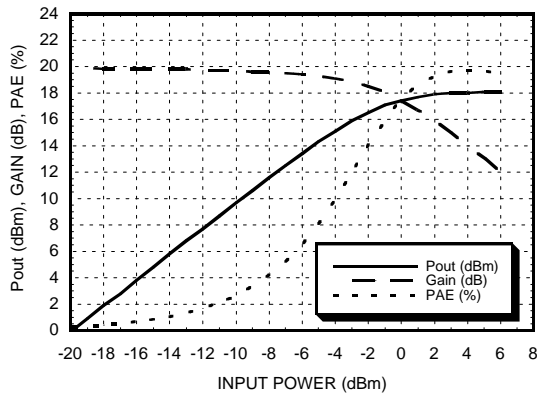

Power Compression @ 2.5 GHz
Vdd= +3V

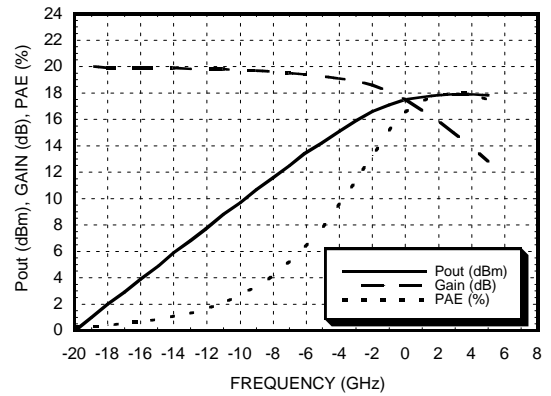

Psat vs. Temperature
@ Vdd= +3V

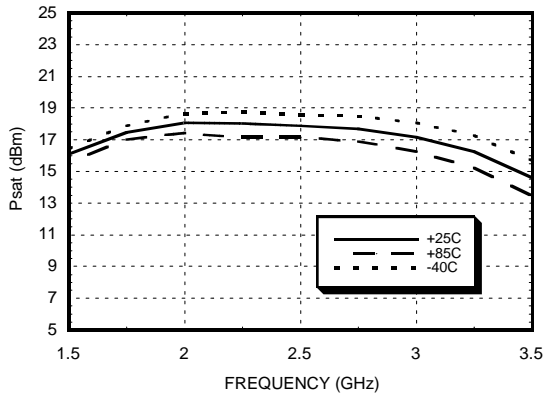

P1dB vs. Temperature
@ Vdd= +3V

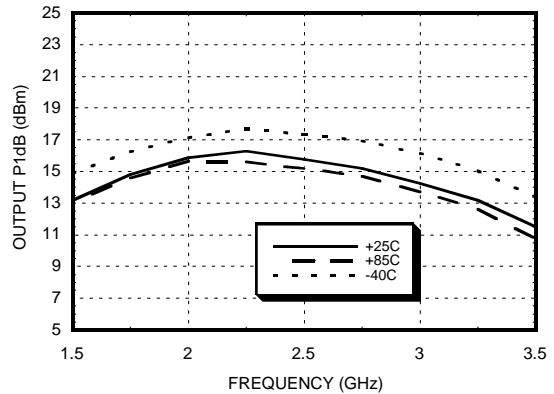

Output IP3 vs. Temperature
@ Vdd= +3V

	Frequency (GHz)		
Temperature	2.0	2.5	3.0
-40 °C	27.8	27.8	25.7
+25 °C	27.7	27.5	25.5
+85 °C	27.3	26.9	24.6

All levels in dBm

1
AMPLIFIERS
SMT



100 mW MEDIUM POWER GaAs IC AMPLIFIER 1.7 - 3.0 GHz

FEBRUARY 2001

v01.1200

Schematic

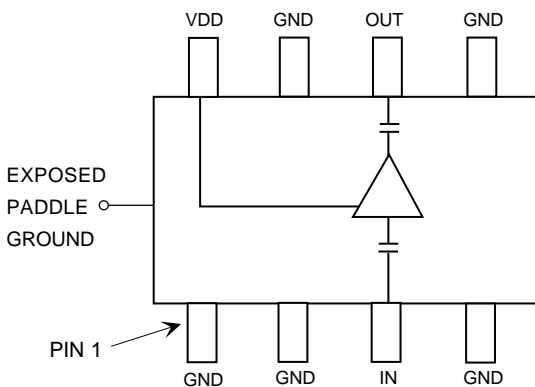

Absolute Maximum Ratings

Supply Voltage (Vdd)	+8 Vdc
Input Power (RFin)(Vdd = +5V)	+10 dBm
Channel Temperature (Tc)	175 °C
Thermal Resistance (Θjc) (Channel Backside)	65 °C/W
Storage Temperature	-65 to +150 °C
Operating Temperature	-55 to +85 °C

Note: 100pF bypass capacitor to ground on Vdd line recommended.

Outline

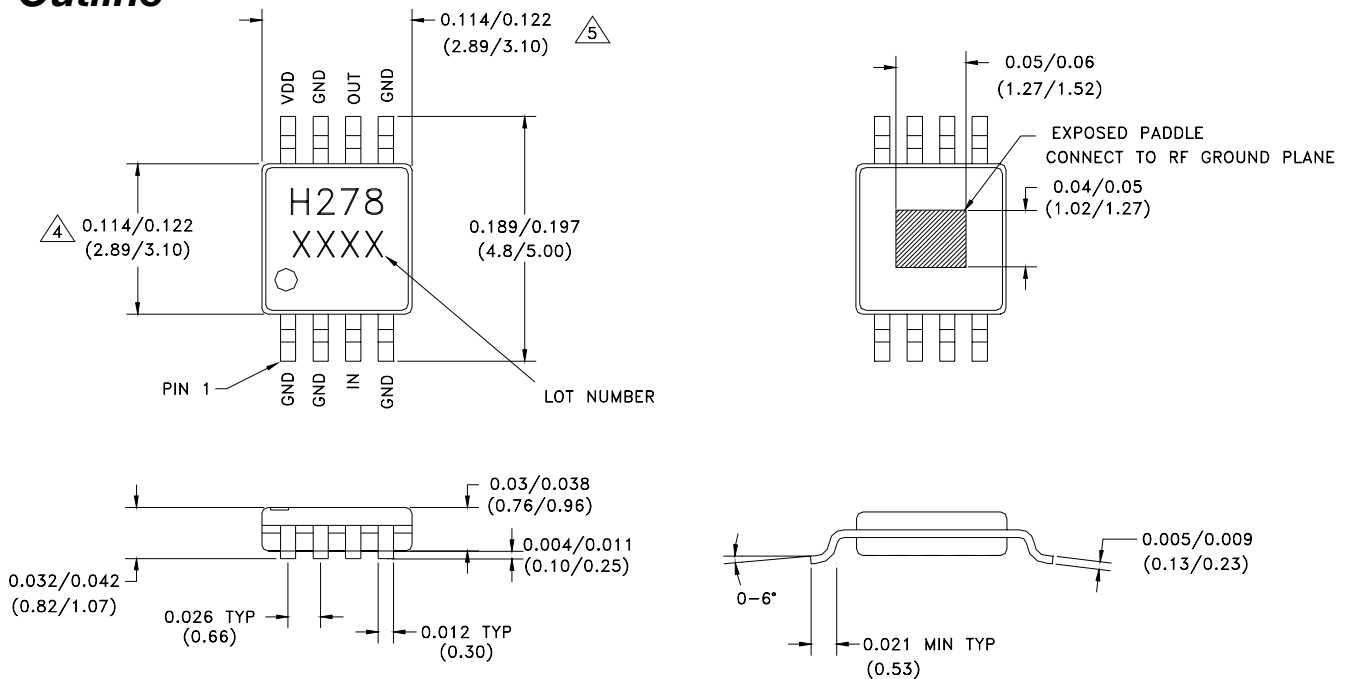

- | | |
|------------------------------------------------------------------------------------------------------------------------------------------------------------------------------------------------------------------------------------------------------------------------------------------------------------------------------------------------------------------------------------------------------------------------|-------------------------------------------------------------------------------------------------------------------------------------|
| <ol style="list-style-type: none"> 1. MATERIAL: <ul style="list-style-type: none"> A) PACKAGE BODY - LOW STRESS INJECTION-MOLDED PLASTIC. B) LEADFRAME & PADDLE MATERIAL: COPPER ALLOY 2. PLATING: LEAD & PADDLE- TIN SOLDER PLATE 3. DIMENSIONS ARE IN INCHES (MILLIMETERS).
UNLESS OTHERWISE SPECIFIED ALL TOL. ARE ±0.005(±0.13). | <p>⚠ DIMENSION DOES NOT INCLUDE MOLDFLASH OF 0.15 MM PER SIDE</p> <p>⚠ DIMENSION DOES NOT INCLUDE MOLDFLASH OF 0.25 MM PER SIDE</p> |
|------------------------------------------------------------------------------------------------------------------------------------------------------------------------------------------------------------------------------------------------------------------------------------------------------------------------------------------------------------------------------------------------------------------------|-------------------------------------------------------------------------------------------------------------------------------------|

1 AMPLIFIERS SMT

100 mW MEDIUM POWER GaAs IC AMPLIFIER 1.7 - 3.0 GHz

v01.1200

FEBRUARY 2001

Recommended PCB Layout for HMC278MS8G

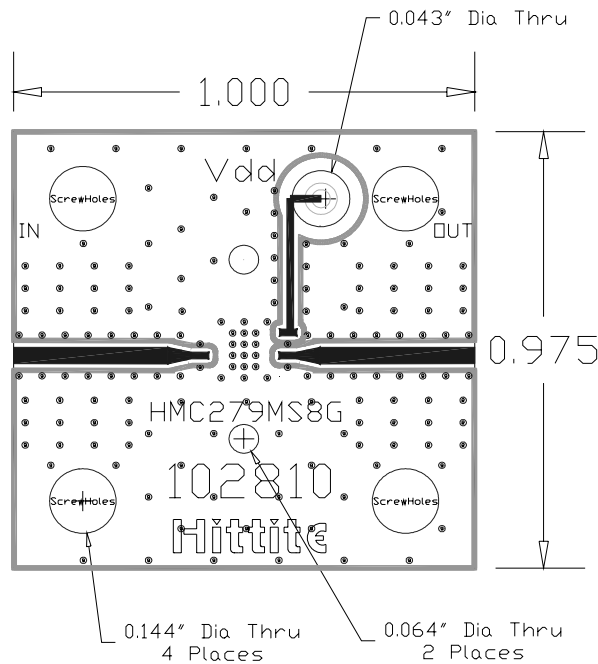

1
AMPLIFIERS
SMT



The circuit board used in the final application should use RF circuit design techniques. Signal lines should have 50 ohm impedance while the package ground leads and exposed paddle should be connected directly to the ground plane similar to that shown above. A sufficient number of VIA holes should be used to connect the top and bottom ground planes. The evaluation circuit board as shown is available from Hittite upon request.

Evaluation Circuit Board Layout Design Details

Layout Technique	Grounded Co-Planar Waveguide (GCPW)
Material	Rogers 4350
Dielectric Thickness	0.020" (0.51 mm)
50 Ohm Line Width	0.034" (0.86 mm)
Gap to Ground Edge	0.010" (0.25 mm)
Ground VIA Hole Diameter	0.014" (0.36 mm)
Connectors	SMA-F (EF - Johnson P/N 142-0701-806)