

TOSHIBA BIPOLAR LINEAR INTEGRATED CIRCUIT SILICON MONOLITHIC

TAR8H02K

Dual Low-Dropout Regulator

TAR8H02K is a bipolar type 2-system output power supply with a control pin. ON and OFF can be switched using the control pin.

Features

- Include 2-regulators (2.8 V, 2.8 V)
- Overtemperature/overcurrent protection
- Very small 8-pin package

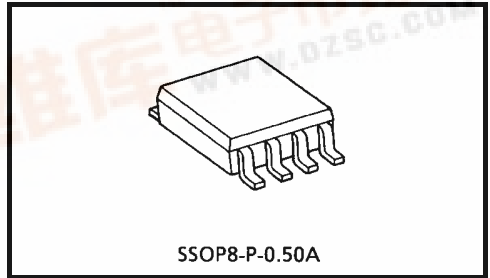

Weight: 0.01 g (typ.)

Pin Assignment (top view)

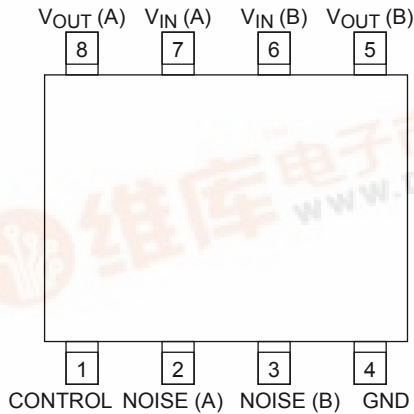

$V_{OUT} (A) = 2.8 V$

$V_{OUT} (B) = 2.8 V$

Marking

8H02

Overtemperature protection and overcurrent protection functions are not necessary guarantee of operating ratings below the absolute maximum ratings.

Do not use devices under conditions in which their absolute maximum ratings will be exceeded.



Absolute Maximum Ratings (Ta = 25°C)

Characteristics	Symbol	Rating	Unit
Supply Voltage	V _{IN}	12	V
Output Current (A-channel)	I _{OUT} (A)	100	mA
Output Current (B-channel)	I _{OUT} (B)	150	
Power Dissipation	P _D	200 (Note 1)	mW
		400 (Note 2)	
Operation Temp. Range	T _{opr}	-40 to 85	°C
Storage Temp. Range	T _{stg}	-55 to 150	°C

Note: Using continuously under heavy loads (e.g. the application of high temperature/current/voltage and the significant change in temperature, etc.) may cause this product to decrease in the reliability significantly even if the operating conditions (i.e. operating temperature/current/voltage, etc.) are within the absolute maximum ratings and the operating ranges.

Please design the appropriate reliability upon reviewing the Toshiba Semiconductor Reliability Handbook ("Handling Precautions"/"Derating Concept and Methods") and individual reliability data (i.e. reliability test report and estimated failure rate, etc).

Note 1: Unit Rating

Note 2: Mounted on a glass epoxy circuit board of 30 × 30 mm Pad dimension of 70 mm²

Electrical Characteristics (unless otherwise specified, V_{IN} = 3.6 V, C_{IN} = 1 μF, C_{OUT} = 10 μF, C_{NOISE} = 0.01 μF, V_{CT} = 3.6 V, T_j = 25°C)

2.8 V Output Characteristics (V_{OUT} (A))

Characteristics	Symbol	Test Condition	Min	Typ.	Max	Unit
Output Voltage	V _{OUT} (A)	I _{OUT} (A) = 30 mA	2.72	2.8	2.88	V
Dropout Voltage	V _{IN} -V _{OUT} (A)	V _{IN} = 2.6 V, I _{OUT} (A) = 30 mA	—	130	200	mV
Load Regulation	Reg·load (A)	I _{OUT} (A) = 0 mA to 30 mA	—	10	30	mV
Line Regulation	Reg·line (A)	V _{IN} = 4.0 V to 8.0 V	—	1	20	mV
Temp. Coefficient	T _{CV0} (A)	Ta = -40°C to 85°C	—	100	—	ppm/°C
Ripple Rejection	R.R. ₁ (A)	V _{IN} = 5.0 V, I _{OUT} (A) = 10 mA, f = 200 Hz, V _{Ripple} = 1 V _{p-p} , Ta = 25°C	—	65	—	dB
	R.R. ₂ (A)	V _{IN} = 5.0 V, I _{OUT} (A) = 10 mA, f = 200 kHz, V _{Ripple} = 1 V _{p-p} , Ta = 25°C	—	50	—	dB
Output Noise Voltage	V _{NO} (A)	I _{OUT} (A) = 10 mA, 10 Hz ≤ f ≤ 10 kHz, Ta = 25°C	—	30	—	μV _{rms}
Output Rise Time	t _{rise} (A)	I _{OUT} (A) = 30 mA, V _{CT} = 0 V → 3 V (t _r = 10 ns)	—	1	—	ms

2.8 V Output Characteristics (V_{OUT} (B))

Characteristics	Symbol	Test Condition	Min	Typ.	Max	Unit
Output Voltage	V _{OUT} (B)	I _{OUT} (B) = 30 mA	2.72	2.8	2.88	V
Dropout Voltage	V _{IN} -V _{OUT} (B)	V _{IN} = 2.6 V, I _{OUT} (B) = 30 mA	—	120	190	mV
Load Regulation	Reg·load (B)	I _{OUT} (B) = 0 mA to 30 mA	—	10	30	mV
Line Regulation	Reg·line (B)	V _{IN} = 4.0 V to 8.0 V	—	1	20	mV
Temp. Coefficient	T _{CV0} (B)	T _a = -40°C to 85°C	—	100	—	ppm/°C
Ripple Rejection	R.R. ₁ (B)	V _{IN} = 5.0 V, I _{OUT} (B) = 10 mA, f = 200 Hz, V _{Ripple} = 1 V _{p-p} , T _a = 25°C	—	65	—	dB
	R.R. ₂ (B)	V _{IN} = 5.0 V, I _{OUT} (B) = 10 mA, f = 200 kHz, V _{Ripple} = 1 V _{p-p} , T _a = 25°C	—	50	—	dB
Output Noise Voltage	V _{NO} (B)	I _{OUT} (B) = 10 mA, 10 Hz ≤ f ≤ 10 kHz, T _a = 25°C	—	30	—	μV _{rms}
Output Rise Time	t _{rise} (B)	I _{OUT} (B) = 30 mA, V _{CT} = 0 V → 3 V (t _r = 10 ns)	—	1	—	ms

Common Characteristics

Characteristics	Symbol	Test Condition	Min	Typ.	Max	Unit
Stand-by Current	I _B (OFF)	V _{CT} = 0 V	—	—	10	μA
Quiescent Current	I _B	I _{OUT} (A) = 30 mA, I _{OUT} (B) = 30 mA	—	0.8	1.8	mA
Control Voltage (ON)	V _{CT} (ON)	—	2.2	—	V _{IN}	V
Control Voltage (OFF)	V _{CT} (OFF)	—	—	—	0.4	V
Control Input Current	I _{CT}	V _{CT} = 3 V (output ON)	—	—	30	μA

Application Note · Recommended Application circuit

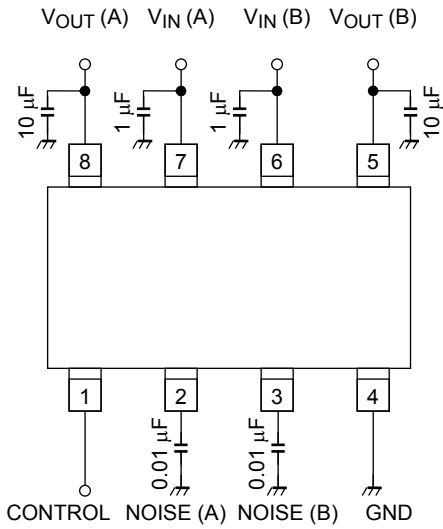

Control level	A-channel	B-channel
HIGH	ON	ON
LOW	OFF	OFF

The noise capacitor should be connected to NOISE pin to GND for stable operation.

The recommended value is higher than 0.0047 μ F.

The figure above shows commended configuration for using a point regulator. Insert a capacitor for stable input/output operation.

If the control function is not to be used, Toshiba recommended that the control pin be connected to the Vcc pin.

▪

Ripple Rejection

TAR8H02K feature a circuit with an excellent ripple rejection characteristic. Because the circuit also features an excellent output fluctuation characteristic for sudden supply voltage drops, the circuit is ideal for in the RF blocks incorporated in all mobile telephones.

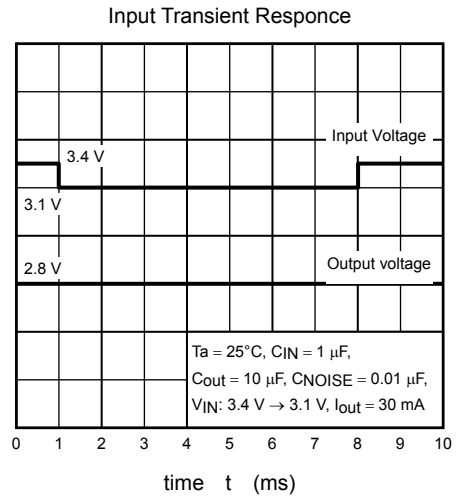
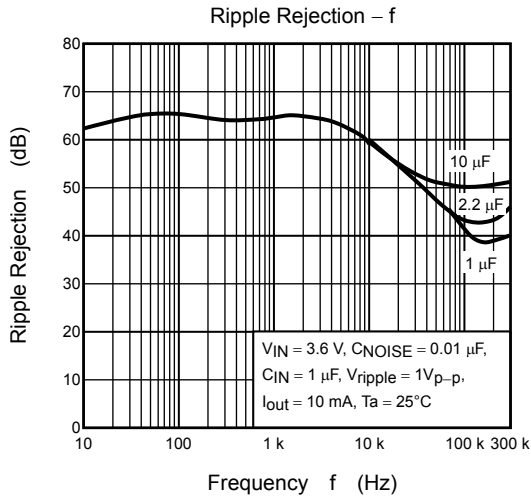

NOISE Pin

TAR8H02K device incorporate a NOISE pin to reduce output noise voltage. Inserting a capacitor between the NOISE pin and GND reduces output noise. To ensure stable operation, insert a capacitor of 0.0047 μF or more between the NOISE pin and GND.

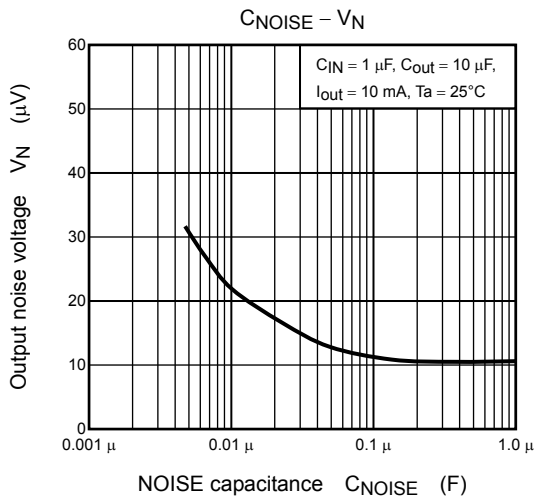

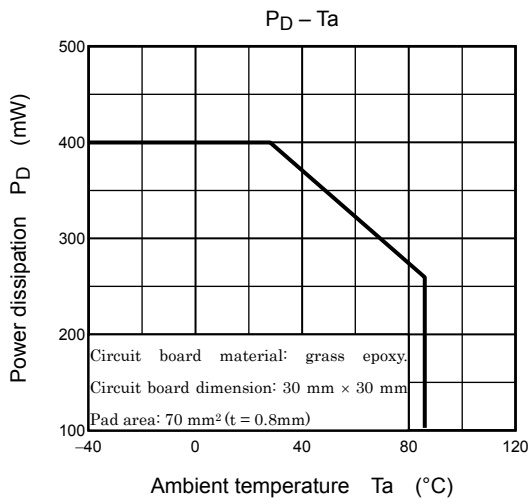
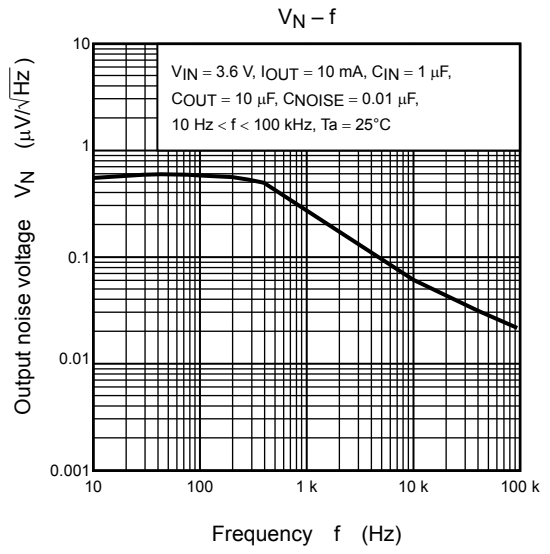
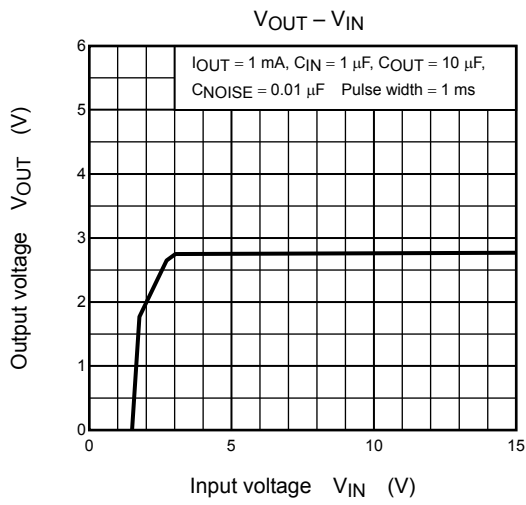

Package Dimensions

SSOP8-P-0.50A

Unit : mm

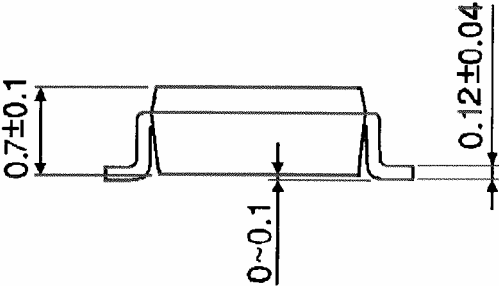
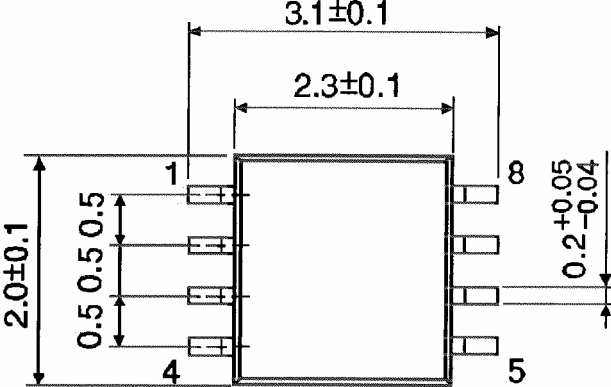

Weight: 0.01 g (Typ.)

RESTRICTIONS ON PRODUCT USE

20070701-EN GENERAL

- The information contained herein is subject to change without notice.
- TOSHIBA is continually working to improve the quality and reliability of its products. Nevertheless, semiconductor devices in general can malfunction or fail due to their inherent electrical sensitivity and vulnerability to physical stress. It is the responsibility of the buyer, when utilizing TOSHIBA products, to comply with the standards of safety in making a safe design for the entire system, and to avoid situations in which a malfunction or failure of such TOSHIBA products could cause loss of human life, bodily injury or damage to property.
In developing your designs, please ensure that TOSHIBA products are used within specified operating ranges as set forth in the most recent TOSHIBA products specifications. Also, please keep in mind the precautions and conditions set forth in the "Handling Guide for Semiconductor Devices," or "TOSHIBA Semiconductor Reliability Handbook" etc.
- The TOSHIBA products listed in this document are intended for usage in general electronics applications (computer, personal equipment, office equipment, measuring equipment, industrial robotics, domestic appliances, etc.). These TOSHIBA products are neither intended nor warranted for usage in equipment that requires extraordinarily high quality and/or reliability or a malfunction or failure of which may cause loss of human life or bodily injury ("Unintended Usage"). Unintended Usage include atomic energy control instruments, airplane or spaceship instruments, transportation instruments, traffic signal instruments, combustion control instruments, medical instruments, all types of safety devices, etc.. Unintended Usage of TOSHIBA products listed in this document shall be made at the customer's own risk.
- The products described in this document shall not be used or embedded to any downstream products of which manufacture, use and/or sale are prohibited under any applicable laws and regulations.
- The information contained herein is presented only as a guide for the applications of our products. No responsibility is assumed by TOSHIBA for any infringements of patents or other rights of the third parties which may result from its use. No license is granted by implication or otherwise under any patents or other rights of TOSHIBA or the third parties.
- Please contact your sales representative for product-by-product details in this document regarding RoHS compatibility. Please use these products in this document in compliance with all applicable laws and regulations that regulate the inclusion or use of controlled substances. Toshiba assumes no liability for damage or losses occurring as a result of noncompliance with applicable laws and regulations.