

International IOR Rectifier

20TQ...
20TQ...S

SCHOTTKY RECTIFIER

20 Amp

$I_{F(AV)} = 19\text{Amp}$
 $V_R = 35/45\text{V}$

Major Ratings and Characteristics

Characteristics	Values	Units
$I_{F(AV)}$ Rectangular waveform	20	A
V_{RRM} range	35/45	V
I_{FSM} @ $t_p = 5\ \mu\text{s}$ sine	1800	A
V_F @ 20 Apk, $T_J = 125^\circ\text{C}$	0.51	V
T_J range	-55 to 150	$^\circ\text{C}$

Description/ Features

The 20TQ Schottky rectifier series has been optimized for very low forward voltage drop, with moderate leakage. The proprietary barrier technology allows for reliable operation up to 150°C junction temperature. Typical applications are in switching power supplies, converters, free-wheeling diodes, and reverse battery protection.

- 150°C T_J operation
- High purity, high temperature epoxy encapsulation for enhanced mechanical strength and moisture resistance
- Low forward voltage drop
- High frequency operation
- Guard ring for enhanced ruggedness and long term reliability

Case Styles

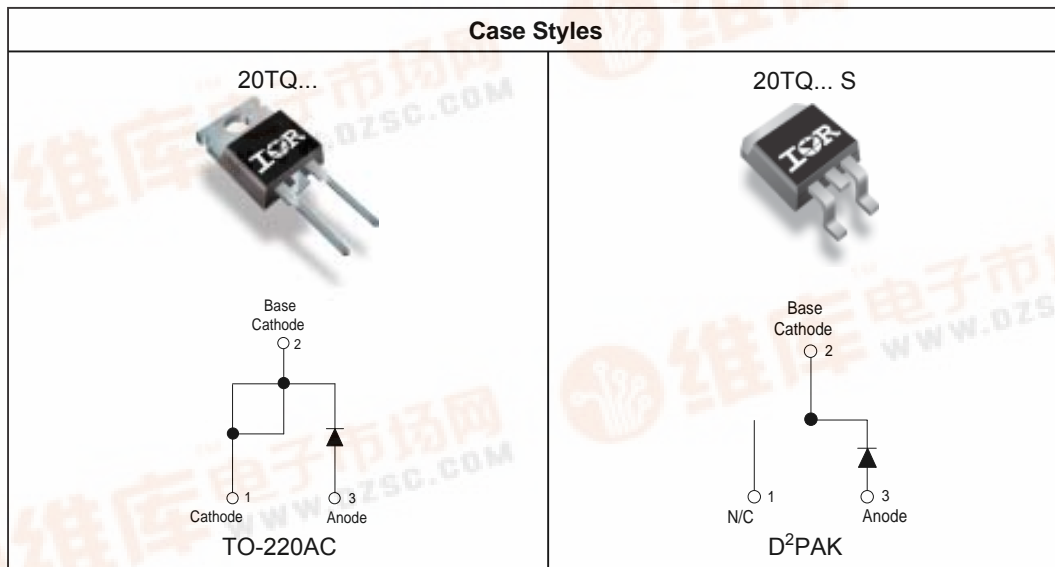

Voltage Ratings

Part number	20TQ035	20TQ040	20TQ045
V_R Max. DC Reverse Voltage (V)	35	40	45
V_{RWM} Max. Working Peak Reverse Voltage (V)			

Absolute Maximum Ratings

Parameters	20TQ	Units	Conditions
$I_{F(AV)}$ Max. Average Forward Current * See Fig. 5	20	A	50% duty cycle @ $T_C = 116^\circ\text{C}$, rectangular wave form
I_{FSM} Max. Peak One Cycle Non-Repetitive Surge Current * See Fig. 7	1800	A	Following any rated load condition and with rated V_{RWM} applied
	400		
E_{AS} Non-Repetitive Avalanche Energy	27	mJ	$T_J = 25^\circ\text{C}$, $I_{AS} = 4$ Amps, $L = 3.4$ mH
I_{AR} Repetitive Avalanche Current	4	A	Current decaying linearly to zero in 1 μsec Frequency limited by T_J max. $V_A = 1.5 \times V_R$ typical

Electrical Specifications

Parameters	20TQ	Units	Conditions
V_{FM} Max. Forward Voltage Drop (1) * See Fig. 1	0.57	V	@ 20A $T_J = 25^\circ\text{C}$
	0.73	V	@ 40A
	0.51	V	@ 20A $T_J = 125^\circ\text{C}$
	0.67	V	@ 40A
I_{RM} Max. Reverse Leakage Current (1) * See Fig. 2	2.7	mA	$T_J = 25^\circ\text{C}$
	105	mA	$T_J = 125^\circ\text{C}$ $V_R = \text{rated } V_R$
C_T Max. Junction Capacitance	1400	pF	$V_R = 5V_{DC}$ (test signal range 100Khz to 1Mhz) 25°C
L_S Typical Series Inductance	8.0	nH	Measured lead to lead 5mm from package body
dv/dt Max. Voltage Rate of Change (Rated V_R)	10000	V/ μs	

(1) Pulse Width < 300 μs , Duty Cycle < 2%

Thermal-Mechanical Specifications

Parameters	20TQ	Units	Conditions
T_J Max. Junction Temperature Range	-55 to 150	$^\circ\text{C}$	
T_{stg} Max. Storage Temperature Range	-55 to 150	$^\circ\text{C}$	
R_{thJC} Max. Thermal Resistance Junction to Case	1.50	$^\circ\text{C/W}$	DC operation * See Fig. 4
R_{thCS} Typical Thermal Resistance, Case to Heatsink	0.50	$^\circ\text{C/W}$	Mounting surface, smooth and greased
wt Approximate Weight	2 (0.07)		g (oz.)
T Mounting Torque	Min.	6 (5)	Kg-cm (lbf-in)
	Max.	12 (10)	
Marking Device	20TQ045		Case Style TO-220
	20TQ045S		Case Style D ² Pak

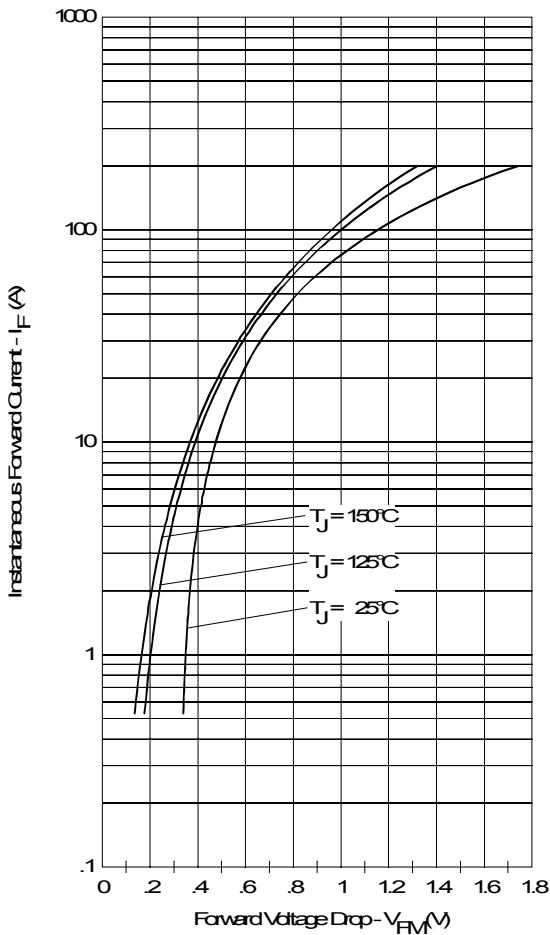

Fig. 1 - Maximum Forward Voltage Drop Characteristics

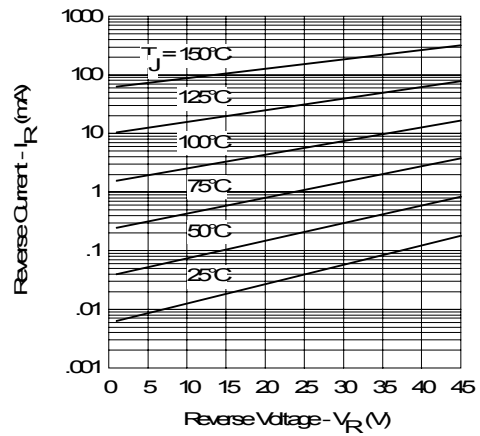

Fig. 2 - Typical Values of Reverse Current Vs. Reverse Voltage

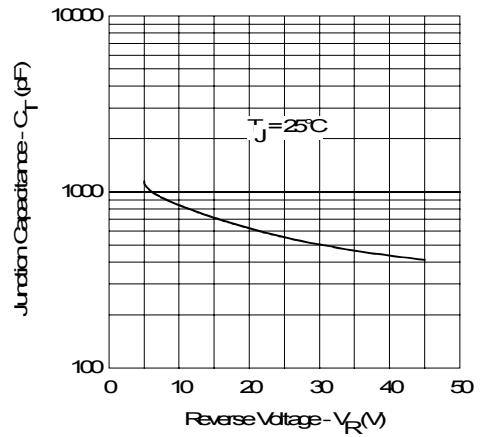

Fig. 3 - Typical Junction Capacitance Vs. Reverse Voltage

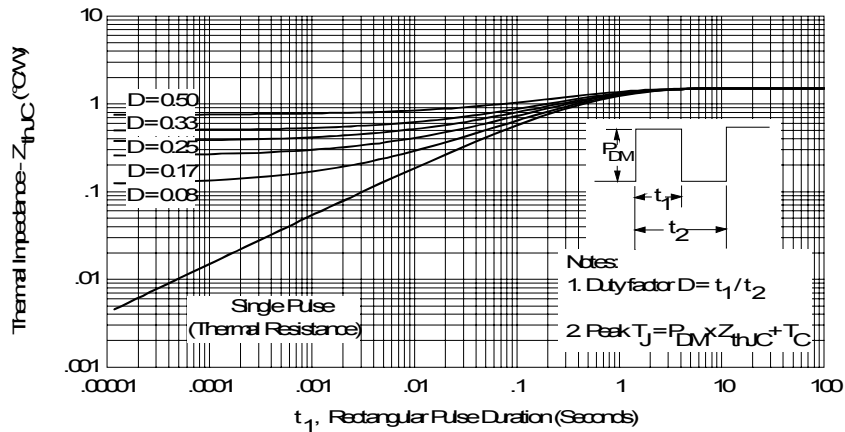

Fig. 4 - Maximum Thermal Impedance Z_{thJC} Characteristics

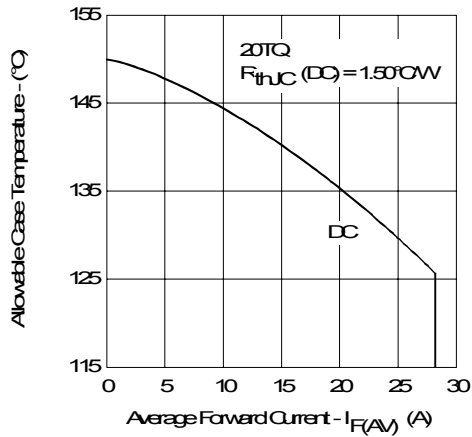

Fig. 5 - Maximum Allowable Case Temperature Vs. Average Forward Current

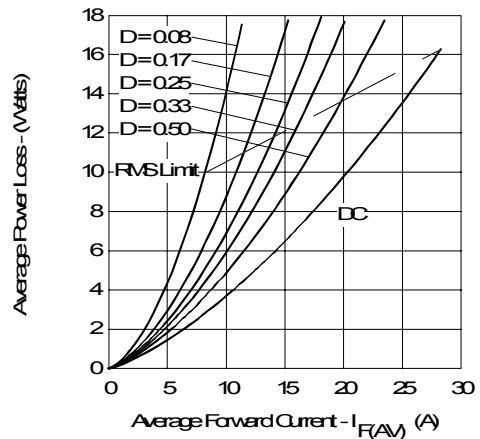

Fig. 6 - Forward Power Loss Characteristics

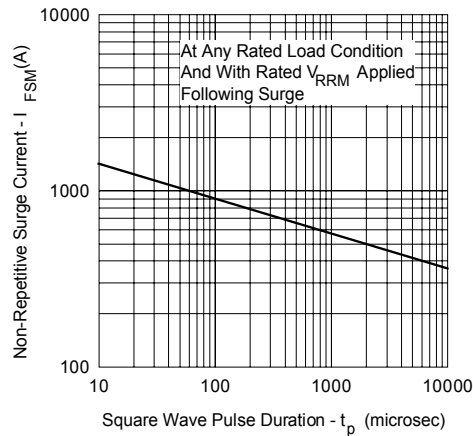

Fig. 7 - Maximum Non-Repetitive Surge Current

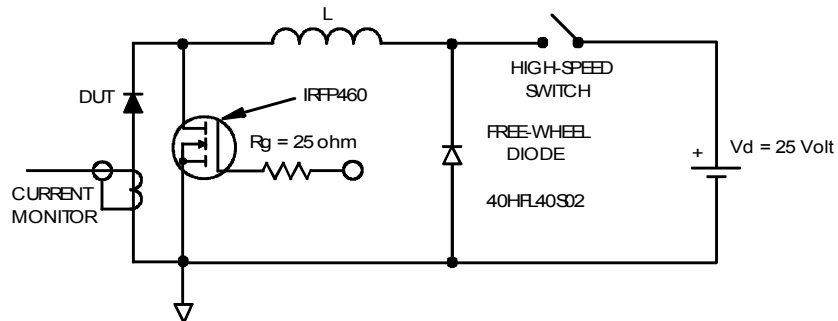
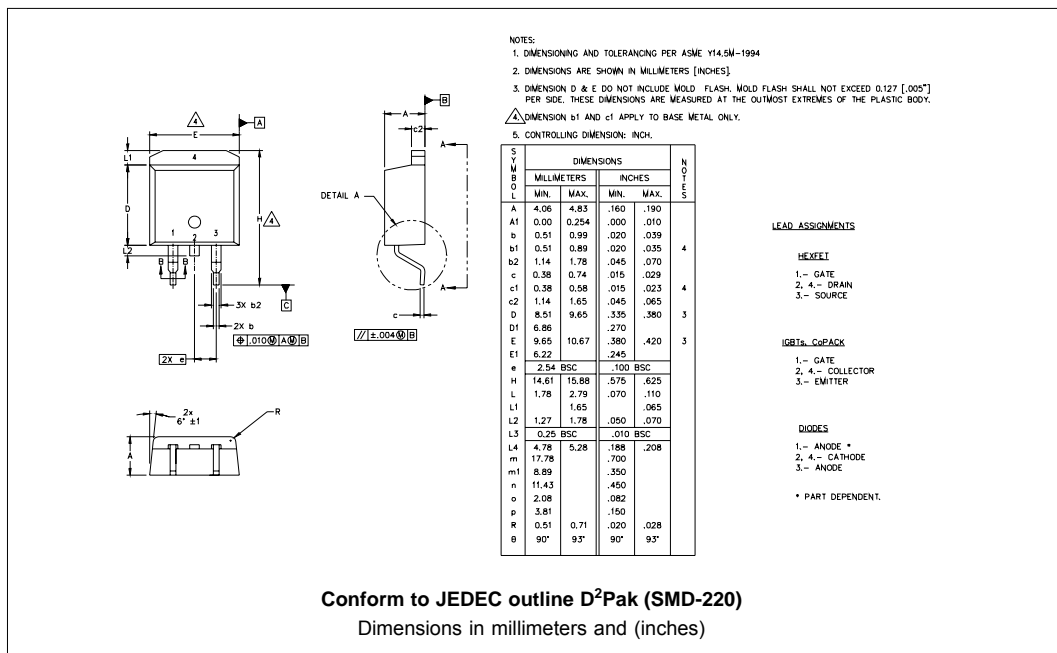
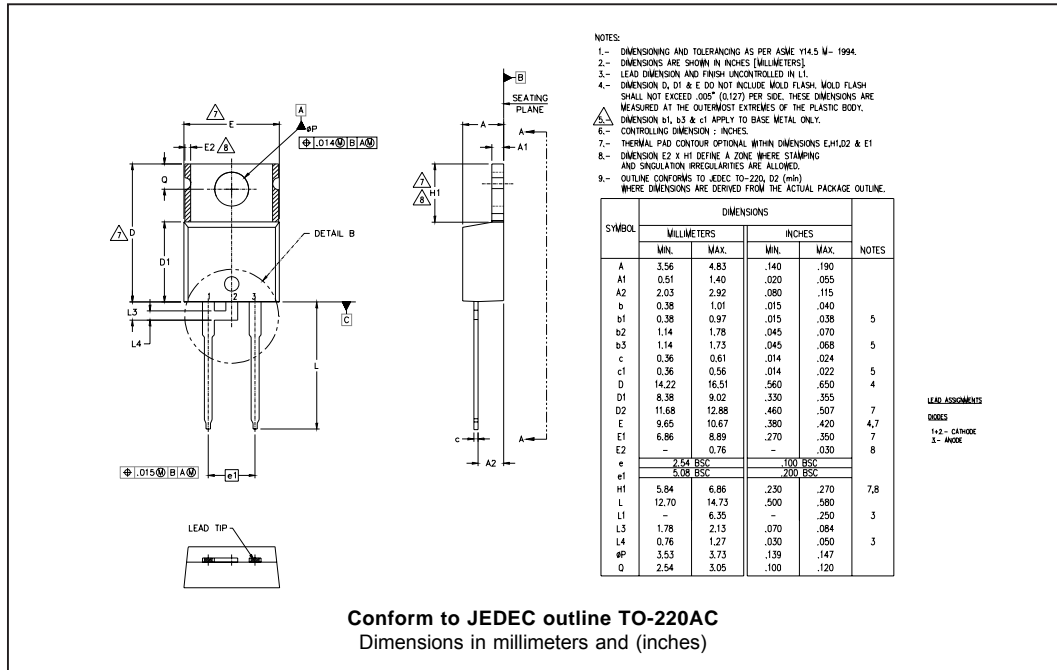

Fig. 8 - Unclamped Inductive Test Circuit

Outline Table



Part Marking Information

TO-220AC

EXAMPLE: THIS IS A 20TQ045
 LOT CODE 1789
 ASSEMBLED ON WW 19, 2001
 IN THE ASSEMBLY LINE "C"

INTERNATIONAL
RECTIFIER
LOGO

ASSEMBLY
LOT CODE

PART NUMBER

DATE CODE
YEAR 1 = 2001
WEEK 19
LINE C

D²Pak

EXAMPLE: THIS IS A 20TQ045S
 LOT CODE 8024
 ASSEMBLED ON WW 02, 2000

INTERNATIONAL
RECTIFIER
LOGO

ASSEMBLY
LOT CODE

PART NUMBER

DATE CODE
YEAR 0 = 2000
WEEK 02
LINE C

Tape & Reel Information

SECTION Y-Y

NOTES:

- 1.0 10 SPROCKET HOLE PITH CUMULATIVE TOLERANCE ±.02
- 2.0 CAMBER NOT TO EXCEED 1mm in 100mm
- 3.0 MATERIAL: CONDUCTIVE BLACK STYRENIC ALLOY
- 4.0 Ko MEASURED FROM A PLANE ON THE INSIDE BOTTOM OF THE POCKET TO THE TOP SURFACE OF THE CARRIER
- 5.0 MEASURED FROM CENTRELINE OF SPROCKET HOLE TO CENTRELINE OF POCKET
- 6.0 VENDOR: (OPTIONAL)
- 7.0 MUST ALSO MEET REQUIREMENTS OF EIA STANDAR #EIA-481A TAPING OF SURFACE MOUNT COMPONENTS FOR AUTOMATIC PLACEMENT
- 8.0 SURFACE RESISTIVITY OF MOLDED MATL. MUST MEASURE LESS OR EQUAL TO 10⁶ OHMS PER SQUARE. MEASURED IN ACCORDANCE TO PROCEDURE GIVEN IN ASTM D-257 & ASTM D-991
- 9.0 TOTAL LENGTH PER REEL MUST BE 45 METERS
- 10.0 Ⓞ CRITICAL

Ao	10.50	+/- 0.1
Bo	15.80	+/- 0.1
B2	10.25	+/- 0.1
Ko	4.90	+/- 0.1
F	11.50	+/- 0.1
P1	16.00	+/- 0.1
W	24.00	+/- 0.3

Dimensions in millimeters and (inches)

Ordering Information Table

Device Code													
	<table border="1" style="margin: auto;"> <tr> <td style="padding: 5px;">20</td> <td style="padding: 5px;">T</td> <td style="padding: 5px;">Q</td> <td style="padding: 5px;">045</td> <td style="padding: 5px;">S</td> <td style="padding: 5px;">-</td> </tr> <tr> <td style="text-align: center;">①</td> <td style="text-align: center;">②</td> <td style="text-align: center;">③</td> <td style="text-align: center;">④</td> <td style="text-align: center;">⑤</td> <td style="text-align: center;">⑥</td> </tr> </table>	20	T	Q	045	S	-	①	②	③	④	⑤	⑥
20	T	Q	045	S	-								
①	②	③	④	⑤	⑥								
1	- Current Rating (20 = 20A)												
2	- Package T = TO-220												
3	- Schottky "Q" Series												
4	- Voltage Ratings												
5	- <ul style="list-style-type: none"> • none = TO-220 • S = D²Pak 												
6	- <ul style="list-style-type: none"> • none = Standard Production • PbF = Lead-Free 												
	<table border="1" style="margin-right: 20px;"> <tr> <td>035 = 35V</td> </tr> <tr> <td>040 = 40V</td> </tr> <tr> <td>045 = 45V</td> </tr> </table>	035 = 35V	040 = 40V	045 = 45V									
035 = 35V													
040 = 40V													
045 = 45V													
	Tube Standard Pack Quantity : 50 pieces												

Data and specifications subject to change without notice.
 This product has been designed and qualified for Industrial Level.
 Qualification Standards can be found on IR's Web site.