

**ISOTOP® Buck chopper
NPT IGBT**

**$V_{CES} = 600V$
 $I_C = 30A @ T_c = 100^\circ C$**

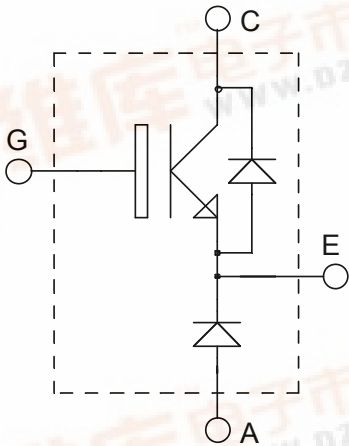

Application

- AC and DC motor control
- Switched Mode Power Supplies

Features

- Non Punch Through (NPT) THUNDERBOLT IGBT®
 - Low voltage drop
 - Low tail current
 - Switching frequency up to 100 kHz
 - Soft recovery parallel diodes
 - Low diode VF
 - Low leakage current
 - Avalanche energy rated
 - RBSOA and SCSOA rated
- ISOTOP® Package (SOT-227)
- Very low stray inductance
- High level of integration

Benefits

- Outstanding performance at high frequency operation
- Stable temperature behavior
- Very rugged
- Direct mounting to heatsink (isolated package)
- Low junction to case thermal resistance
- Easy paralleling due to positive TC of VCEsat

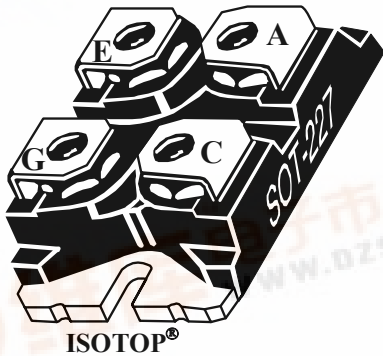

Absolute maximum ratings

Symbol	Parameter	Max ratings	Unit
V_{CES}	Collector - Emitter Breakdown Voltage	600	V
I_{C1}	Continuous Collector Current	$T_c = 25^\circ C$	A
I_{C2}		$T_c = 100^\circ C$	
I_{CM}	Pulsed Collector Current	$T_c = 25^\circ C$	110
V_{GE}	Gate - Emitter Voltage	± 20	V
P_D	Maximum Power Dissipation	$T_c = 25^\circ C$	192
I_{LM}	RBSOA clamped Inductive load Current $R_G=11\Omega$	$T_c = 25^\circ C$	60
I_{FAV}	Maximum Average Forward Current	$T_c = 80^\circ C$	A
I_{FRMS}	RMS Forward Current (Square wave, 50% duty)		

CAUTION: These Devices are sensitive to Electrostatic Discharge. Proper Handling Procedures Should Be Followed.

All ratings @ $T_j = 25^\circ\text{C}$ unless otherwise specified

Electrical Characteristics

Symbol	Characteristic	Test Conditions	Min	Typ	Max	Unit	
BV_{CES}	Collector - Emitter Breakdown Voltage	$V_{GE} = 0V, I_C = 0.25mA$	600			V	
I_{CES}	Zero Gate Voltage Collector Current	$V_{GE} = 0V$ $V_{CE} = 600V$			40 1000	μA	
$V_{CE(on)}$	Collector Emitter on Voltage	$V_{GE} = 15V$ $I_C = 30A$	$T_j = 25^\circ\text{C}$		2.0	2.5	V
			$T_j = 125^\circ\text{C}$		2.2	2.8	
$V_{GE(th)}$	Gate Threshold Voltage	$V_{GE} = V_{CE}, I_C = 700\mu A$	3	4	5	V	
I_{GES}	Gate - Emitter Leakage Current	$V_{GE} = \pm 20V, V_{CE} = 0V$			± 100	nA	

Dynamic Characteristics

Symbol	Characteristic	Test Conditions	Min	Typ	Max	Unit	
C_{ies}	Input Capacitance	$V_{GE} = 0V$ $V_{CE} = 25V$ $f = 1MHz$		1600	1850	pF	
C_{oes}	Output Capacitance			150	220		
C_{res}	Reverse Transfer Capacitance			90	150		
Q_g	Total gate Charge	$V_{GS} = 15V$ $V_{Bus} = 300V$ $I_C = 30A$		140	210	nC	
Q_{ge}	Gate - Emitter Charge			10	15		
Q_{gc}	Gate - Collector Charge			60	90		
$T_{d(on)}$	Turn-on Delay Time	Resistive Switching (25°C) $V_{GE} = 15V$ $V_{Bus} = 300V$ $I_C = 30A$ $R_G = 10\Omega$		13	26	ns	
T_r	Rise Time			41	80		
$T_{d(off)}$	Turn-off Delay Time			147	220		
T_f	Fall Time			200	400		
$T_{d(on)}$	Turn-on Delay Time	Inductive Switching (25°C) $V_{GE} = 15V$ $V_{Bus} = 400V$ $I_C = 30A$ $R_G = 10\Omega$		17	30	ns	
T_r	Rise Time			28	60		
$T_{d(off)}$	Turn-off Delay Time			242	360		
T_f	Fall Time			34	70		
E_{ts}	Total switching Losses			1.2	2	mJ	
$T_{d(on)}$	Turn-on Delay Time	Inductive Switching (150°C) $V_{GE} = 15V$ $V_{Bus} = 400V$ $I_C = 30A$ $R_G = 10\Omega$		15	30	ns	
T_r	Rise Time			27	50		
$T_{d(off)}$	Turn-off Delay Time			265	400		
T_f	Fall Time			41	80		
E_{on}	Turn-on Switching Energy				0.5	1	mJ
E_{off}	Turn-off Switching Energy				1	2	
E_{ts}	Total switching Losses			1.5	3		

Diode ratings and characteristics

<i>Symbol</i>	<i>Characteristic</i>	<i>Test Conditions</i>		<i>Min</i>	<i>Typ</i>	<i>Max</i>	<i>Unit</i>
V _F	Diode Forward Voltage	I _F = 30A			1.6	1.8	V
		I _F = 60A			1.9		
		I _F = 30A	T _j = 125°C		1.4		
I _{RM}	Maximum Reverse Leakage Current	V _R = 600V	T _j = 25°C			250	μA
		V _R = 600V	T _j = 125°C			500	
C _T	Junction Capacitance	V _R = 200V			44		pF
t _{rr}	Reverse Recovery Time	I _F =1A, V _R =30V di/dt =100A/μs	T _j = 25°C		23		ns
	Reverse Recovery Time		T _j = 25°C		85		
I _{RRM}	Maximum Reverse Recovery Current	I _F = 30A V _R = 400V di/dt =200A/μs	T _j = 125°C		160		A
			T _j = 25°C		4		
Q _{rr}	Reverse Recovery Charge		T _j = 125°C		8		nC
			T _j = 25°C		130		
t _{rr}	Reverse Recovery Time	I _F = 30A	T _j = 125°C		70		ns
Q _{rr}	Reverse Recovery Charge	V _R = 400V			1300		nC
I _{RRM}	Maximum Reverse Recovery Current	di/dt =1000A/μs			30		A

Thermal and package characteristics

<i>Symbol</i>	<i>Characteristic</i>		<i>Min</i>	<i>Typ</i>	<i>Max</i>	<i>Unit</i>
R _{thJC}	Junction to Case	IGBT			0.65	°C/W
		Diode			1.21	
R _{thJA}	Junction to Ambient (IGBT & Diode)				20	
V _{ISOL}	RMS Isolation Voltage, any terminal to case t =1 min, I isol<1mA, 50/60Hz		2500			V
T _J , T _{STG}	Storage Temperature Range		-55		150	°C
T _L	Max Lead Temp for Soldering:0.063" from case for 10 sec				300	
Torque	Mounting torque (Mounting = 8-32 or 4mm Machine and terminals = 4mm Machine)				1.5	N.m
Wt	Package Weight			29.2		g

Typical IGBT Performance Curve

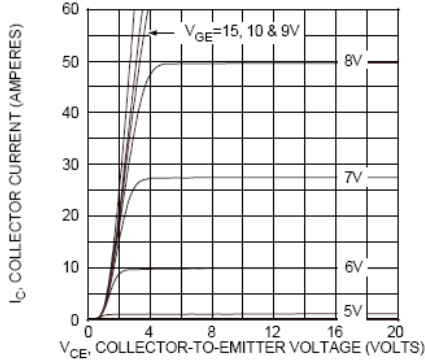

Figure 1, Typical Output Characteristics ($T_J = 25^\circ\text{C}$)

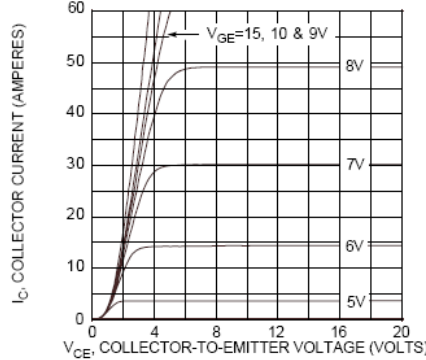

Figure 2, Typical Output Characteristics ($T_J = 150^\circ\text{C}$)

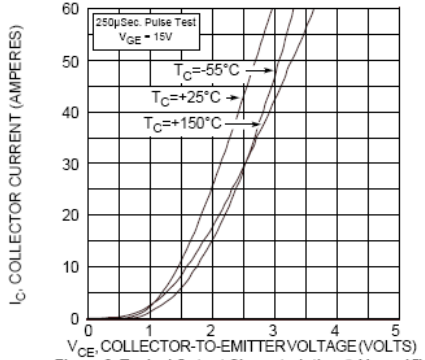

Figure 3, Typical Output Characteristics @ $V_{GE} = 15\text{V}$

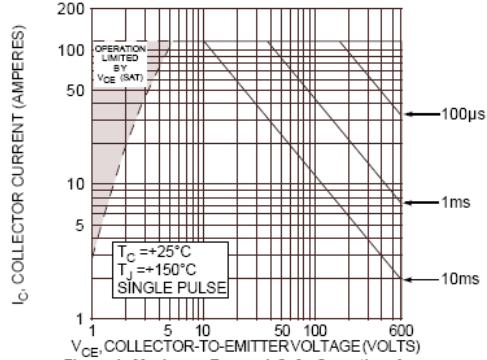

Figure 4, Maximum Forward Safe Operating Area

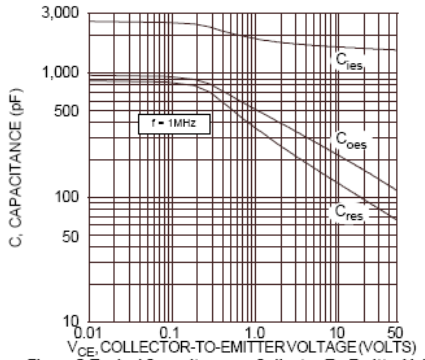

Figure 5, Typical Capacitance vs Collector-To-Emitter Voltage

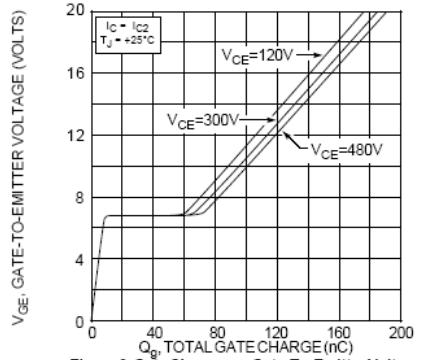

Figure 6, Gate Charges vs Gate-To-Emitter Voltage

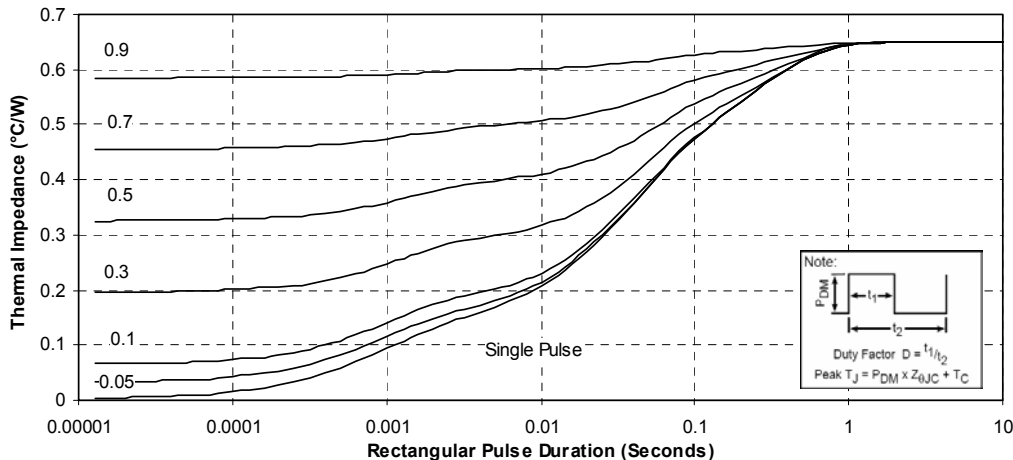

Figure 7, Maximum Effective Transient Thermal Impedance, Junction to Case vs Pulse Duration

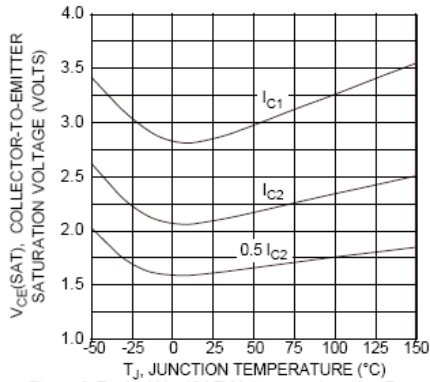

Figure 8, Typical $V_{CE(SAT)}$ Voltage vs Junction Temperature

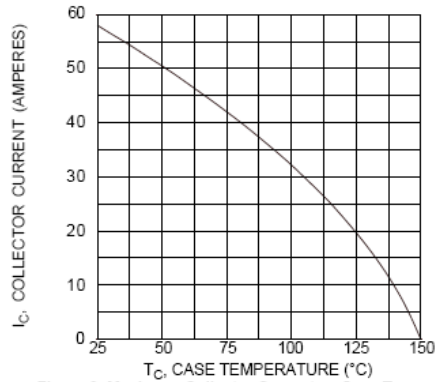

Figure 9, Maximum Collector Current vs Case Temperature

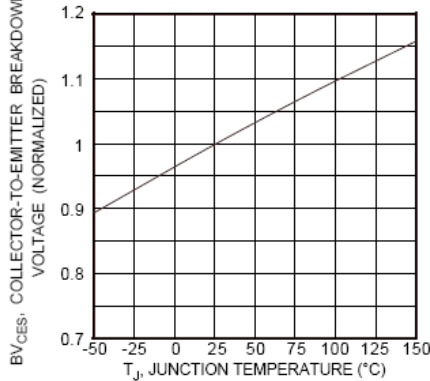

Figure 10, Breakdown Voltage vs Junction Temperature

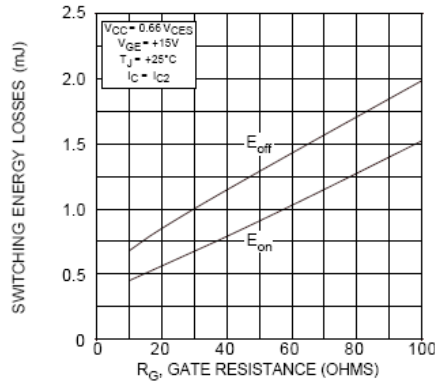

Figure 11, Typical Switching Energy Losses vs Gate Resistance

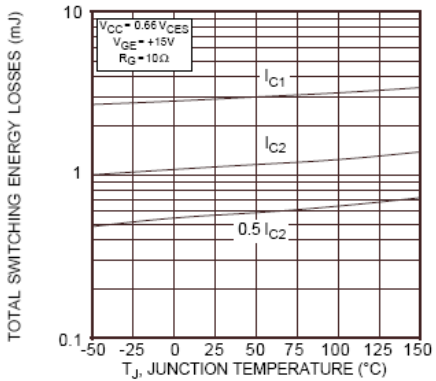

Figure 12, Typical Switching Energy Losses vs. Junction Temperature

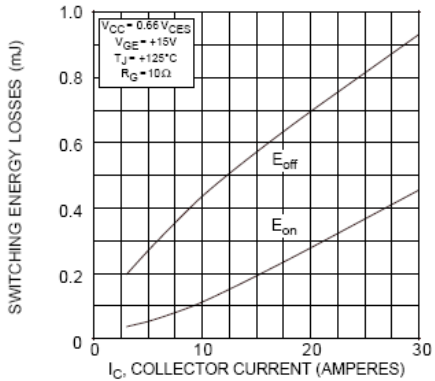

Figure 13, Typical Switching Energy Losses vs Collector Current

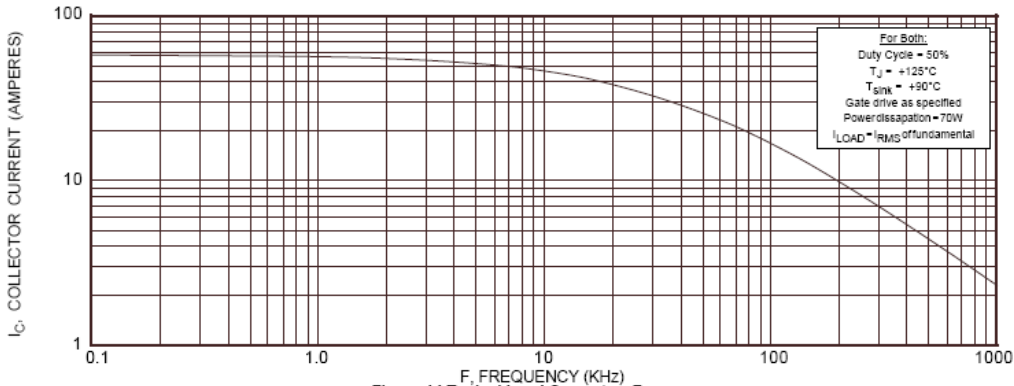

Figure 14, Typical Load Current vs Frequency

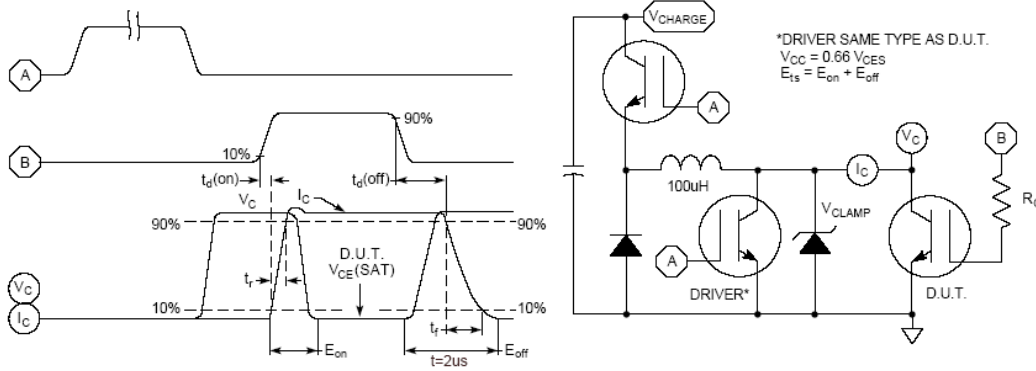

Figure 15, Switching Loss Test Circuit and Waveforms

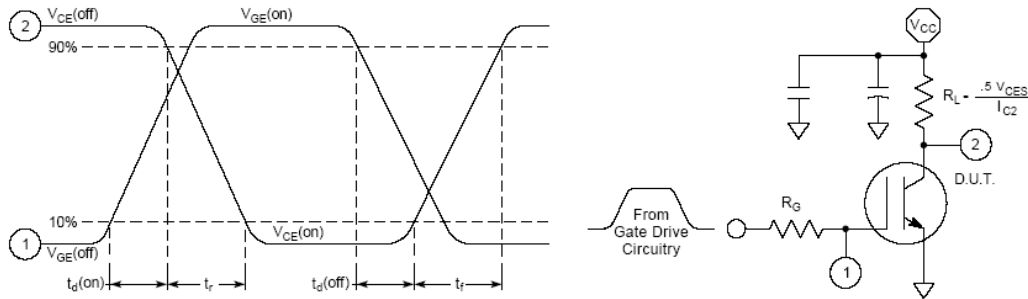

Figure 16, Resistive Switching Time Test Circuit and Waveforms

Typical Diode Performance Curve

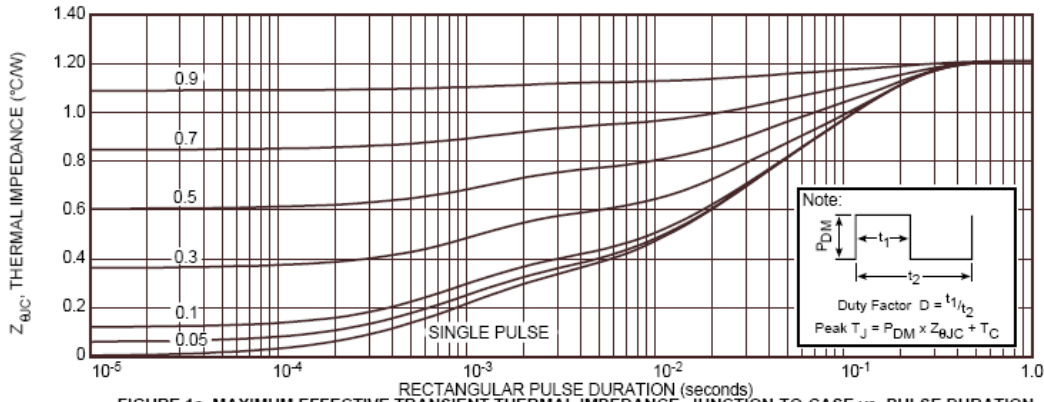

FIGURE 1a. MAXIMUM EFFECTIVE TRANSIENT THERMAL IMPEDANCE, JUNCTION-TO-CASE vs. PULSE DURATION

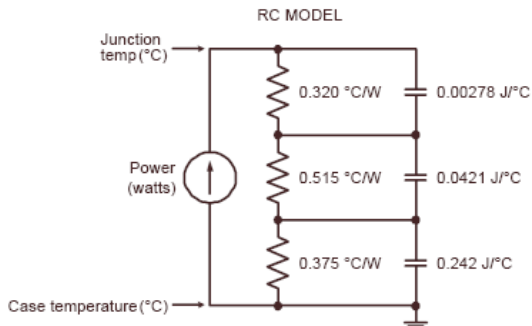

FIGURE 1b, TRANSIENT THERMAL IMPEDANCE MODEL

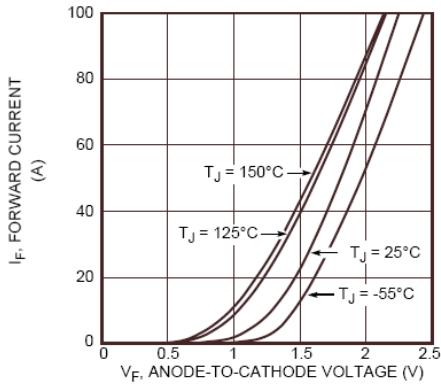

Figure 2. Forward Current vs. Forward Voltage

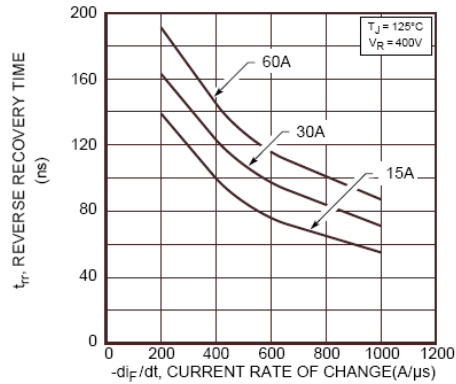

Figure 3. Reverse Recovery Time vs. Current Rate of Change

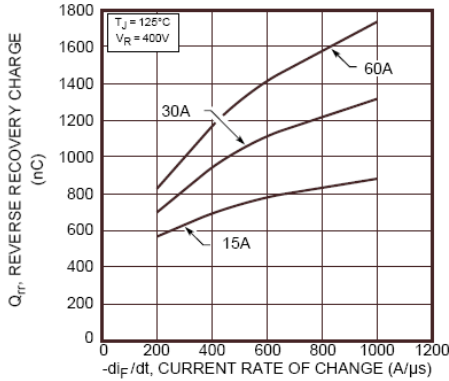

Figure 4. Reverse Recovery Charge vs. Current Rate of Change

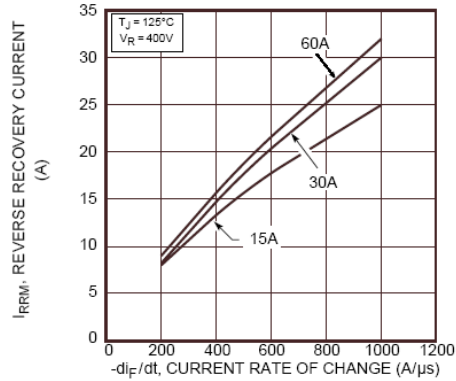

Figure 5. Reverse Recovery Current vs. Current Rate of Change

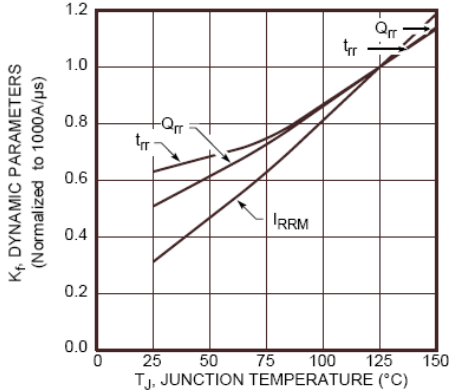

Figure 6. Dynamic Parameters vs. Junction Temperature

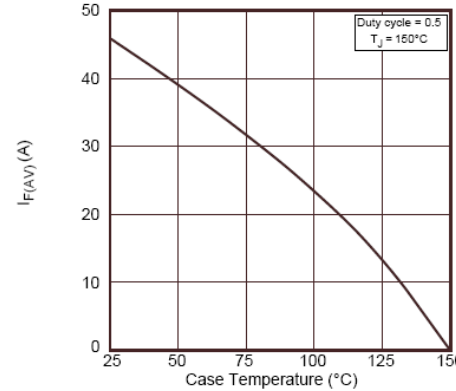

Figure 7. Maximum Average Forward Current vs. Case Temperature

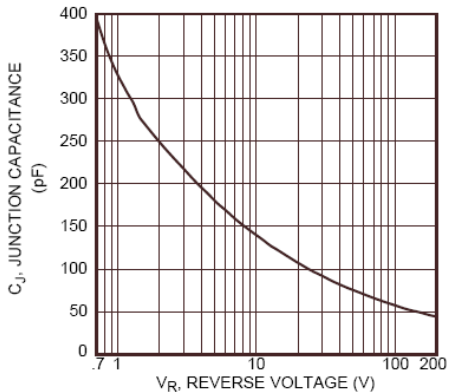

Figure 8. Junction Capacitance vs. Reverse Voltage

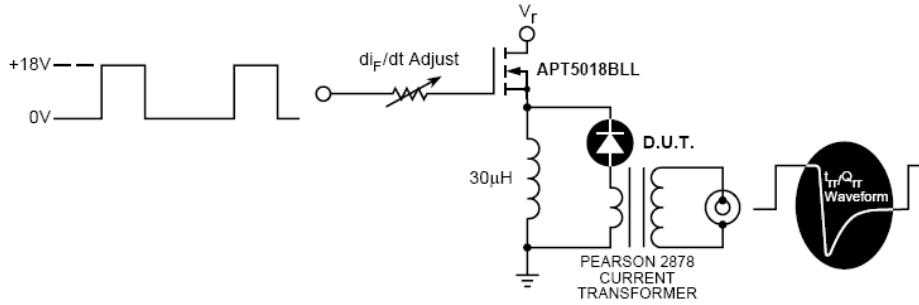

Figure 9. Diode Test Circuit

- 1 I_F - Forward Conduction Current
- 2 di_F/dt - Rate of Diode Current Change Through Zero Crossing.
- 3 I_{RRM} - Maximum Reverse Recovery Current.
- 4 t_{rr} - Reverse Recovery Time, measured from zero crossing where diode current goes from positive to negative, to the point at which the straight line through I_{RRM} and $0.25 \cdot I_{RRM}$ passes through zero.
- 5 Q_{rr} - Area Under the Curve Defined by I_{RRM} and t_{rr} .

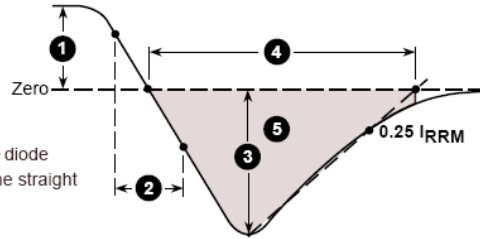
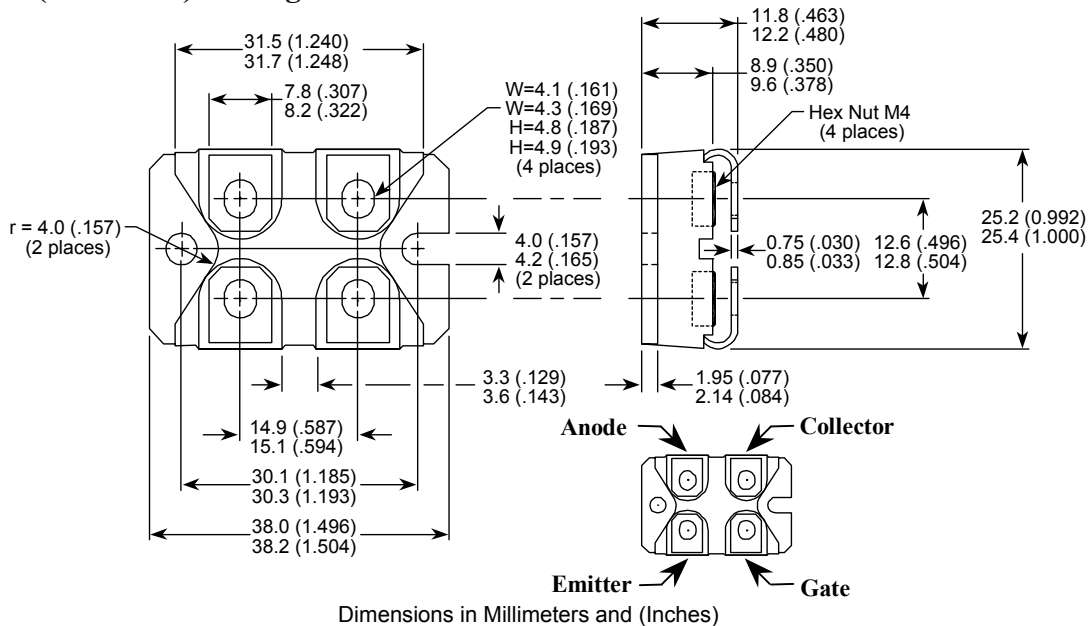

Figure 10. Diode Reverse Recovery Waveform and Definitions

SOT-227 (ISOTOP®) Package Outline



ISOTOP® is a Registered Trademark of SGS Thomson

APT reserves the right to change, without notice, the specifications and information contained herein

APT's products are covered by one or more of U.S patents 4,895,810 5,045,903 5,089,434 5,182,234 5,019,522 5,262,336 6,503,786 5,256,583 4,748,103 5,283,202 5,231,474 5,434,095 5,528,058 and foreign patents. U.S and Foreign patents pending. All Rights Reserved.