



SMT Inductors, SIMID Series

B82498F

SIMID 0805-F

SMD

Size 0805 (EIA) or 2012 (IEC)

Rated inductance ceramic 2.7nH to 820nH

Rated inductance ferrite 1000nH to 6800nH

Rated current from 90 to 1000 mA

Construction

Cubic coil with ceramic or ferrite core
Epoxy moulded flat top for vacuum pickup
Wire welded to terminations

Features

High resonance frequency
Close inductance tolerance
Suitable for reflow (IR and vapor phase)
and wave soldering

Applications

Antenna amplifiers
DECT systems
Mobile phones
Keyless entry
GPS (Global Positioning System)

Terminals

Thick-film coating of Ag/Pd/Pt
Base material AL_2O_3 ceramic or NiZn ferrite

Marking

No marking on component

Minimum data on reel:

Manufacturer, part number, ordering code,
L-Value and tolerance of L-value,
quantity, date of packing

Delivery mode

8-mm blister tape, wound on 178-mm reel

For details on taping, packing and packing units see databook



General technical data

Rated inductance L_R	Measured with impedance analyzer HP 4291A and test fixture 16197 at frequency f_L ; short dimensions 2.0 x 1.2 x 0.8 (mm); 0.9 + 0.1 (mm) pad distance; short inductance 200 pH unconsidered
Q factor Q_{min}	Measured with impedance analyzer HP 4291A and test fixture 16197 at frequency f_Q ; short dimensions 2.0 x 1.2 x 0.8 (mm); 0.9 + 0.1 (mm) pad distance; short inductance 200 pH unconsidered
Rated current I_R	Maximum permissible DC with inductance decrease $\Delta L/L_0 \leq \pm 10\%$ and temperature increase of ≤ 25 K at rated temperature of 125 °C
Self-resonance frequency $f_{res,min}$	Measured with network analyzer HP 8720D
DC resistance R_{max}	Measured at 20°C ambient temperature, measuring current $< I_R$
Climatic category	In accordance with IEC 60068-1 55/150/56 (-55 °C/ +150 °C/ 56 days damp heat test)
Solderability	In accordance with IEC 60068-2-58 (lead free) (245 ± 3) °C, (3 ± 0,3) s Wetting of soldering area: $\geq 90\%$
Resistance to soldering heat	In accordance with IEC 60068-2-20 260 °C, 10 s $\Delta L/L \leq \pm 3\%$
Permissible PCB bending	2 mm (100 mm long standard PCB)
Weight	Approx. 8,5mg (ceramic), 12,5mg (ferrite)

SMD

Dimensional drawing

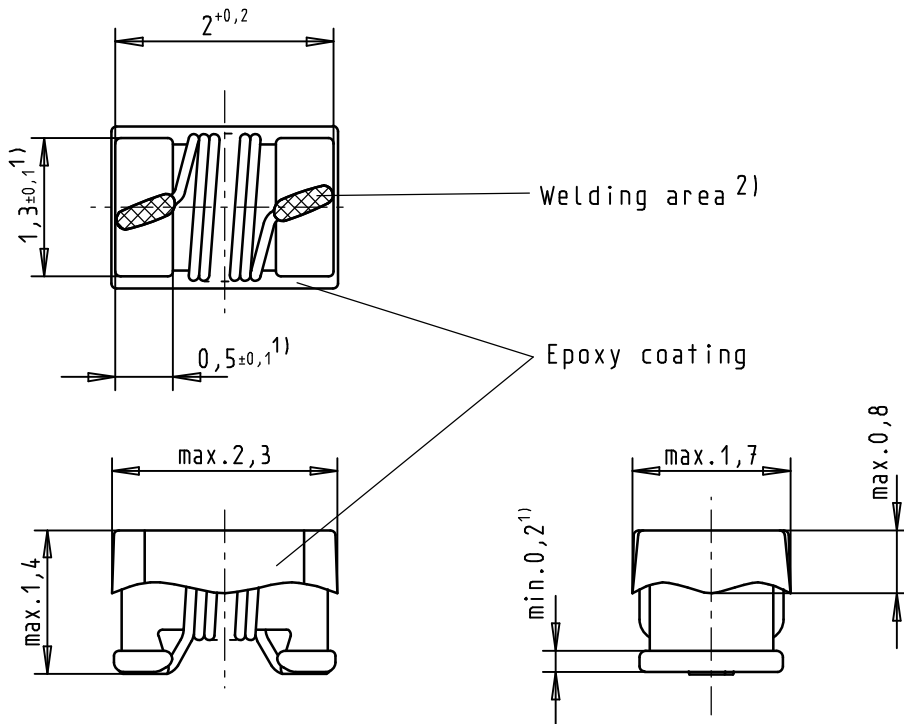

1) Soldering area

2) This area (30% of contact area) should not be used to assess solderability

Layout recommendation

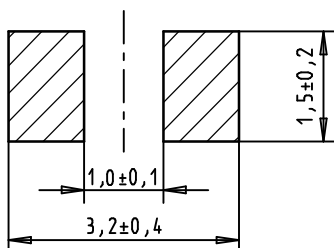

Dimensions in mm.



SMT Inductors, SIMID Series

B82498F

SIMID 0805-F

SMD

Characteristics and ordering codes

L _R	Tolerance ¹⁾	f _L	Q _{min}	f _Q	I _R	R _{max}	f _{res,min}	Ordering code ²⁾ (∅ 180-mm reel)
nH		MHz		MHz	mA	Ω	MHz	

Core material: ceramics

2,7	± 10%	250	50	1500	1000	0.03	9000	B82498F3279+000
5,6	△ K	250	50	1000	900	0.04	7000	B82498F3569+000
6,8		250	50	1000	800	0.05	6000	B82498F3689+000
8,2		250	50	1000	700	0.09	5000	B82498F3829+000
10	± 2%	250	50	500	700	0.09	5000	B82498F3100+000
12	△ G	250	50	500	700	0.09	4000	B82498F3120+000
15	± 5%	250	50	500	650	1.13	3300	B82498F3150+000
18	△ J	250	60	500	700	0.08	3300	B82498F3180+000
22		250	60	500	700	0.08	2500	B82498F3220+000
27		250	60	500	700	0.09	2500	B82498F3270+000
33		250	65	500	600	0.11	2200	B82498F3330+000
39		250	65	500	600	0.12	2100	B82498F3390+000
47		200	65	500	600	0.13	2000	B82498F3470+000
56		200	60	500	600	0.14	1700	B82498F3560+000
68		200	60	500	500	0.18	1600	B82498F3680+000
82		150	60	500	500	0.19	1500	B82498F3820+000
100		150	55	500	450	0.28	1350	B82498F3101+000
120		150	50	250	440	0.31	1250	B82498F3121+000
150		100	45	250	400	0.42	1150	B82498F3151+000
180		100	45	250	340	0.53	1050	B82498F3181+000
220		100	45	250	320	0.70	950	B82498F3221+000
270		100	45	250	270	1.0	900	B82498F3271+000
330		100	45	250	220	1.5	800	B82498F3331+000
390		100	40	250	210	1.6	700	B82498F3391+000
470		50	30	100	190	1.9	650	B82498F3471+000
560		25	23	50	230	1.3	400	B82498F3561+000
680		25	23	50	190	1.7	300	B82498F3681+000
820		25	23	50	180	1.9	300	B82498F3821+000

¹⁾ intermediate values and closer tolerances upon request

²⁾ Replace the + by the code letter for the required inductance tolerance.



SMT Inductors, SIMID Series

B82498F

SIMID 0805-F

SMD

Characteristics and ordering codes (continued)

L_R	Tolerance ¹⁾	f_L	Q_{min}	f_Q	I_R	R_{max}	$f_{res,min}$	Ordering code ²⁾ (\varnothing 180-mm reel)
nH		MHz		MHz	mA	Ω	MHz	

Core material: ferrite

1000	$\pm 5\%$	7.96	20	7.96	240	0.55	440	B82498F1102J000
1200	$\triangle J$	7.96	20	7.96	220	0.65	420	B82498F1122J000
1500		7.96	20	7.96	200	0.70	380	B82498F1152J000
1800		7.96	20	7.96	190	0.98	350	B82498F1182J000
2200		7.96	20	7.96	130	1.60	330	B82498F1222J000
2700		7.96	20	7.96	120	2.00	270	B82498F1272J000
3300		7.96	20	7.96	100	3.30	250	B82498F1332J000
3900		7.96	20	7.96	95	3.60	230	B82498F1392J000
4700		7.96	20	7.96	90	3.80	210	B82498F1472J000
5600		7.96	20	7.96	85	4.30	180	B82498F1562J000
6800		7.96	20	7.96	80	4.70	140	B82498F1682J000

¹⁾ intermediate values and closer tolerances upon request

²⁾ Replace the + by the code letter for the required inductance tolerance.



Q factor (ceramic core) versus frequency f
measured with HP 4291A

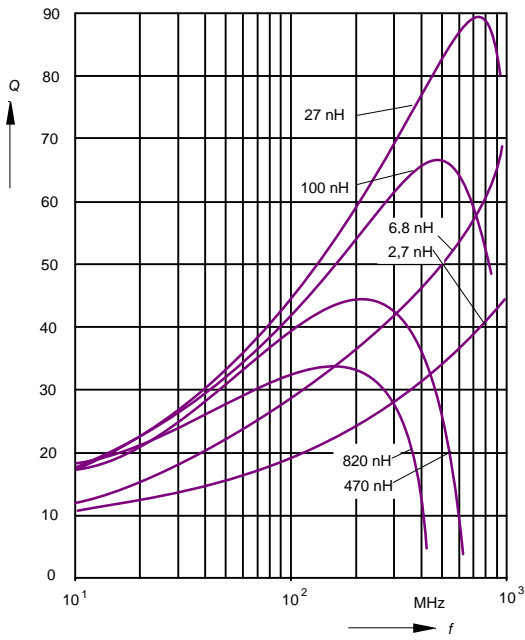

Q factor (ferrite core) versus frequency f
measured with HP 4291A

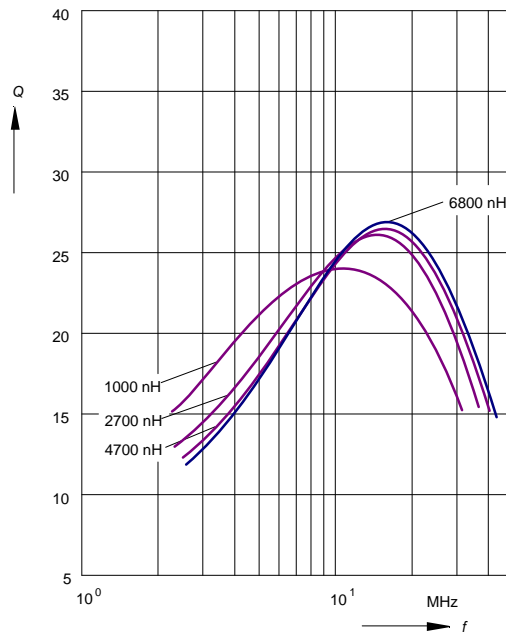

Impedance $|Z|$ versus frequency f (ceramic core)
measured with HP 4291A

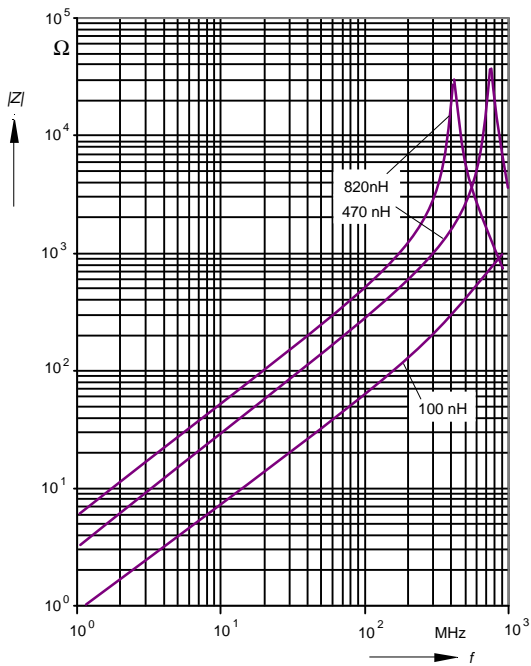

Impedance $|Z|$ versus frequency f (ferrite core)
measured with HP 4291A

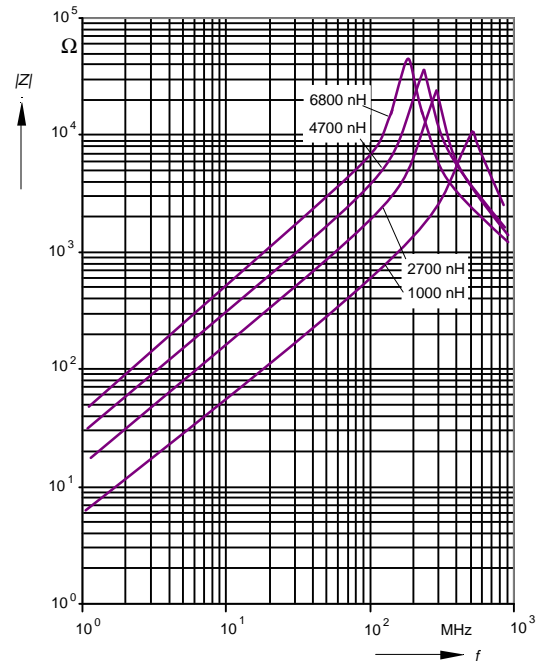



Current derating I_{op}/I_R
versus ambient temperature T_A

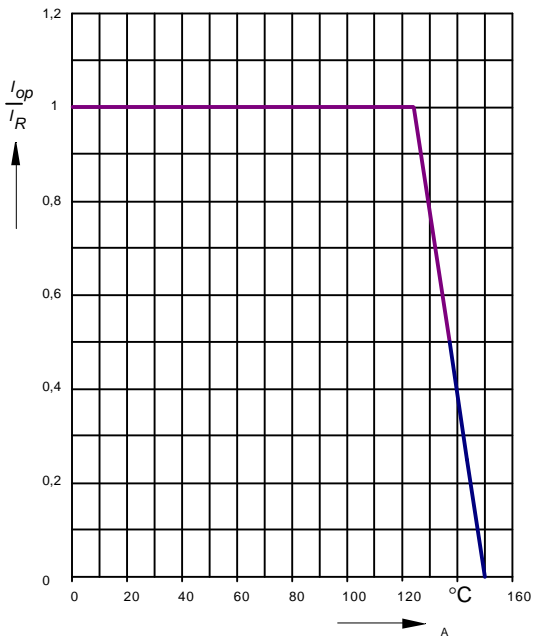

Inductance L versus dc load current I_{DC}
measured with HP 4275A

