

[查询B41851A3107M000供应商](#)

[捷多邦, 专业PCB打样工厂](#)
[, 24小时加急出货](#)



Aluminum electrolytic capacitors

Single-ended capacitors

Series/Type: B41851, B43851

Date: December 2006

© EPCOS AG 2007. Reproduction, publication and dissemination of this publication, enclosures hereto and the information contained therein without EPCOS' prior express consent is prohibited.



General-purpose grade capacitors

Applications

- General-purpose applications in the entertainment industry
- Semi-professional to professional application range
- For filtering, coupling and pulse circuits
- Switched-mode power supplies

Features

- Compact dimensions
- High CV product, i.e. very compact

Construction

- Radial leads
- Charge-discharge proof, polar
- Aluminum case with insulating sleeve
- Minus pole marking on the insulating sleeve
- Case with safety vent from diameter 6.3 mm

Delivery mode

Terminal configurations and packing:

- Bulk
- Taped, Ammo pack
- Cut
- Kinked
- PAPR (protection against polarity reversal):
crimped leads, J leads, bent leads

Refer to chapter "Single-ended capacitors – Taping, packing and lead configurations" for further details and ordering example.

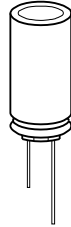



B41851, B43851

Standard series – 105 °C



Specifications and characteristics in brief

| | | | | | | | | | | |
|--|---|------------|------|------------|------|--|------|------|--------------|----------------|
| Series | B41851 | | | | | B43851 | | | | |
| Rated voltage V_R | 6.3 ... 100 V DC | | | | | 160 ... 450 V DC | | | | |
| Surge voltage V_S | $1.15 \cdot V_R$ | | | | | $1.1 \cdot V_R$ | | | | |
| Rated capacitance C_R | 0.1 ... 10000 μF | | | | | 0.47 ... 560 μF | | | | |
| Capacitance tolerance | $\pm 20\% \triangleq M$ | | | | | $\pm 20\% \triangleq M$ | | | | |
| Dissipation factor $\tan \delta$ (20 °C, 120 Hz) | For capacitance higher than 1000 μF add 0.02 for every increase of 1000 μF . | | | | | | | | | |
| | V_R (V DC) | 6.3 | 10 | 16 | 25 | 35 | 50 | 63 | 100 | 160 ... 450 |
| | $\tan \delta$ (max.) | 0.28 | 0.24 | 0.20 | 0.16 | 0.14 | 0.12 | 0.12 | 0.10 | 0.20 |
| Leakage current I_{leak} (20 °C, 5 min) | $I_{\text{leak}} = 0.01 \mu\text{A} \cdot \left(\frac{C_R}{\mu\text{F}} \cdot \frac{V_R}{V} \right)$ or 3 μA , whichever is greater | | | | | $I_{\text{leak}} = 0.03 \mu\text{A} \cdot \left(\frac{C_R}{\mu\text{F}} \cdot \frac{V_R}{V} \right) + 15 \mu\text{A}$ | | | | |
| Self-inductance ESL | Diameter (mm) | ≤ 6.3 | | 8 ... 12.5 | 16 | | 18 | | 20 ... 25 | |
| | ESL (nH) | 15 | | 20 | 26 | | 34 | | 40 | |
| Useful life 105 °C, V_R , $I_{\text{AC,R}}$ 40 °C, V_R , $1.8 \cdot I_{\text{AC,R}}$ 40 °C, V_R , $2.1 \cdot I_{\text{AC,R}}$ | > 2000 h | | | | | > 3000 h | | | | |
| | > 250000 h | | | | | – | | | | |
| Requirements | – | | | | | > 250000 h | | | | |
| | $\Delta C/C \leq \pm 45\%$ of initial value | | | | | | | | | |
| | $\tan \delta \leq 3$ times initial specified limit | | | | | | | | | |
| Voltage endurance test 105 °C, V_R | $I_{\text{leak}} \leq$ initial specified limit | | | | | | | | | |
| | 1000 h | | | | | 1000 h | | | | |
| Post test requirements | $\Delta C/C \leq \pm 30\%$ of initial value | | | | | | | | | |
| | $\tan \delta \leq 2$ times initial specified limit | | | | | | | | | |
| | $I_{\text{leak}} \leq$ initial specified limit | | | | | | | | | |
| Vibration resistance test | To IEC 60068-2-6, test Fc: Displacement amplitude 0.75 mm, frequency range 10 ... 2000 Hz, acceleration max. 20 g, duration 3×2 h. Capacitor rigidly clamped by the aluminum case. | | | | | | | | | |
| IEC climatic category | To IEC 60068-1: | | | | | | | | | |
| | $V_R \leq 250$ V: 40/105/56 (–40 °C/+105 °C/56 days damp heat test) $V_R \geq 350$ V: 25/105/56 (–25 °C/+105 °C/56 days damp heat test) | | | | | | | | | |
| Sectional specification | IEC 60384-4 | | | | | | | | | |



B41851, B43851

Standard series – 105 °C

Dimensional drawings

With stand-off rubber seal

Diameters (mm):

6.3, 8, 10, 12.5, 16, 18, 22, 25

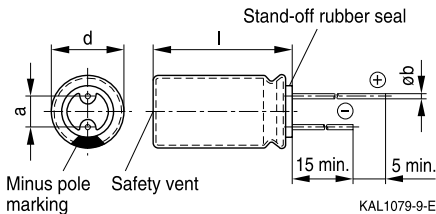

With flat rubber seal

Diameters (mm):

5, 8, 20

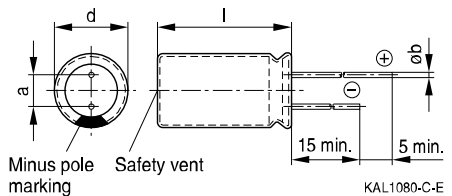

Safety vent for diameter ≥ 6.3 mm.

Dimensions and weights

| Dimensions (mm) | | | | Approx. weight |
|-----------------|-----------|-------------|-----------------|----------------|
| d +0.5 | l | a ± 0.5 | b | g |
| 5 | 11 +1.0 | 2.0 | 0.50 ± 0.05 | 0.5 |
| 6.3 | 11 +1.0 | 2.5 | 0.50 ± 0.05 | 0.7 |
| 8 | 11.5 +1.5 | 3.5 | 0.60 ± 0.05 | 1.0 |
| 10 | 12.5 +1.0 | 5.0 | 0.60 ± 0.05 | 1.6 |
| 10 | 16 +1.0 | 5.0 | 0.60 ± 0.05 | 1.9 |
| 10 | 20 +2.0 | 5.0 | 0.60 ± 0.05 | 2.6 |
| 12.5 | 20 +2.0 | 5.0 | 0.60 ± 0.05 | 3.6 |
| 12.5 | 25 +2.0 | 5.0 | 0.60 ± 0.05 | 4.5 |
| 16 | 20 +2.0 | 7.5 | 0.80 ± 0.05 | 5.5 |
| 16 | 25 +2.0 | 7.5 | 0.80 ± 0.05 | 7.5 |
| 16 | 31.5 +2.0 | 7.5 | 0.80 ± 0.05 | 7.8 |
| 18 | 31.5 +2.0 | 7.5 | 0.80 ± 0.1 | 11.0 |
| 18 | 35 +2.0 | 7.5 | 0.80 ± 0.1 | 13.0 |
| 18 | 40 +2.0 | 7.5 | 0.80 ± 0.1 | 16.0 |
| 20 | 30 +2.0 | 10.0 | 1.0 ± 0.1 | 14.0 |
| 20 | 35 +2.0 | 10.0 | 1.0 ± 0.1 | 18.0 |
| 20 | 40 +2.0 | 10.0 | 1.0 ± 0.1 | 20.0 |
| 22 | 35 +2.0 | 10.0 | 1.0 ± 0.1 | 21.0 |
| 22 | 40 +2.0 | 10.0 | 1.0 ± 0.1 | 23.0 |
| 25 | 40 +2.0 | 12.5 | 1.0 ± 0.1 | 25.0 |



B41851

Standard series – 105 °C



Overview of available types – B41851

Other voltage and capacitance ratings are available upon request.

| V _R (V DC) | 6.3 | 10 | 16 | 25 |
|-----------------------|----------------------------|-----------|------------------------|-----------------------|
| | Case dimensions d × l (mm) | | | |
| C _R (μF) | | | | |
| 47 | | | | 5 × 11 |
| 68 | | | 5 × 11 | |
| 100 | | 5 × 11 | 5 × 11 | 6.3 × 11 |
| 150 | | 6.3 × 11 | 6.3 × 11 | 6.3 × 11 |
| 220 | 6.3 × 11 | 6.3 × 11 | 6.3 × 11 | 8 × 11.5 |
| 270 | 6.3 × 11 | 6.3 × 11 | 8 × 11.5 | 8 × 11.5 |
| 330 | 6.3 × 11 | 8 × 11.5 | 8 × 11.5 | 8 × 11.5 10 × 12.5 |
| 470 | 8 × 11.5 | 8 × 11.5 | 8 × 11.5 | 10 × 12.5 |
| 560 | 8 × 11.5 | 8 × 11.5 | 10 × 12.5 | 10 × 16 |
| 680 | 10 × 12.5 | 10 × 12.5 | 10 × 12.5 | 10 × 16 |
| 1000 | 10 × 12.5 | 10 × 12.5 | 10 × 16 | 10 × 20 |
| 1500 | 10 × 16 | 10 × 20 | 10 × 20 | 12.5 × 20 |
| 2200 | 10 × 20 | 10 × 20 | 12.5 × 20 | 12.5 × 25 |
| 3300 | 10 × 20 | 12.5 × 25 | 12.5 × 25 16 × 25 | 16 × 25 |
| 4700 | 12.5 × 25 | 16 × 20 | 16 × 25 | 16 × 31.5 |
| 6800 | | 16 × 25 | 16 × 31.5 18 × 31.5 | 18 × 35 |
| 8200 | | 16 × 31.5 | 18 × 31.5 | 18 × 40 |
| 10000 | | 18 × 31.5 | 18 × 35 | 20 × 40 |



B41851

Standard series – 105 °C

| V _R (V DC) | 35 | 50 | 63 | 100 |
|-----------------------|----------------------------|----------------------|------------------------|-----------|
| | Case dimensions d × l (mm) | | | |
| C _R (μF) | | | | |
| 0.10 | | | | 5 × 11 |
| 0.22 | | | | 5 × 11 |
| 0.33 | | | | 5 × 11 |
| 0.47 | | | | 5 × 11 |
| 0.68 | | | | 5 × 11 |
| 1.0 | | 5 × 11 | | 5 × 11 |
| 1.5 | | | | 5 × 11 |
| 2.2 | | 5 × 11 | | 5 × 11 |
| 3.3 | | 5 × 11 | | 5 × 11 |
| 4.7 | | 5 × 11 | | 5 × 11 |
| 6.8 | | | 5 × 11 | |
| 10 | | 5 × 11 | 5 × 11 | 6.3 × 11 |
| 22 | | 5 × 11 | 5 × 11 6.3 × 11 | 8 × 11.5 |
| 33 | 5 × 11 | 6.3 × 11 | 6.3 × 11 | 10 × 12.5 |
| 47 | 5 × 11 | 6.3 × 11 | 6.3 × 11 8 × 11.5 | 10 × 12.5 |
| 68 | 6.3 × 11 | 6.3 × 11 | 8 × 11.5 | 10 × 16 |
| 100 | 6.3 × 11 | 8 × 11.5 | 8 × 11.5 | 10 × 20 |
| 150 | 8 × 11.5 | 8 × 11.5 | 10 × 12.5 | 12.5 × 25 |
| 220 | 8 × 11.5 | 10 × 12.5 | 10 × 16 | 12.5 × 25 |
| 270 | 10 × 12.5 | 10 × 16 | 10 × 20 | 16 × 25 |
| 330 | 10 × 12.5 | 10 × 16 | 10 × 20 | 16 × 25 |
| 470 | 10 × 16 | 10 × 20 | 12.5 × 20 12.5 × 25 | 16 × 31.5 |
| 560 | 10 × 20 | 12.5 × 20 | 12.5 × 25 | 16 × 31.5 |
| 680 | 10 × 20 | 12.5 × 20 | 16 × 20 | 18 × 40 |
| 1000 | 12.5 × 20 | 12.5 × 25 | 16 × 25 16 × 31.5 | 20 × 40 |
| 1500 | 16 × 20 | 16 × 25 | 18 × 31.5 | |
| 2200 | 16 × 25 | 16 × 31.5 18 × 35 | 18 × 35 18 × 40 | |
| 3300 | 16 × 31.5 | 18 × 35 | 20 × 40 | |
| 4700 | 18 × 35 | 20 × 40 | 25 × 40 | |
| 6800 | 18 × 40 | | | |



B43851

Standard series – 105 °C



Overview of available types – B43851

Other voltage and capacitance ratings are available upon request.

| V _R (V DC) | 160 | 200 | 250 | 350 | 400 | 450 |
|-----------------------|----------------------------|------------------------|----------------------|--------------------|----------------------|------------------------|
| | Case dimensions d × l (mm) | | | | | |
| C _R (μF) | | | | | | |
| 0.47 | 6.3 × 11 | 6.3 × 11 | 6.3 × 11 | 6.3 × 11 | | |
| 0.68 | 6.3 × 11 | 6.3 × 11 | 6.3 × 11 | 6.3 × 11 | | |
| 1.0 | 6.3 × 11 | 6.3 × 11 | 6.3 × 11 | 6.3 × 11 | | |
| 1.5 | 6.3 × 11 | 6.3 × 11 | 6.3 × 11 | 8 × 11.5 | | |
| 2.2 | 6.3 × 11 | 6.3 × 11 | 6.3 × 11 | 8 × 11.5 | 10 × 12.5 | 10 × 12.5 |
| 3.3 | 6.3 × 11 | 6.3 × 11 | 8 × 11.5 | 10 × 12.5 | 10 × 12.5 | 10 × 16 |
| 4.7 | 6.3 × 11 | 8 × 11.5 | 8 × 11.5 | 10 × 12.5 | 10 × 16 | 10 × 16 10 × 20 |
| 6.8 | 8 × 11.5 | 10 × 12.5 | 10 × 12.5 | 10 × 16 | 10 × 16 | 10 × 20 |
| 10 | 8 × 11.5 | 10 × 12.5 | 10 × 12.5 10 × 16 | 10 × 20 | 10 × 20 | 10 × 20 12.5 × 25 |
| 22 | 10 × 12.5 10 × 16 | 10 × 16 10 × 20 | 10 × 20 | 12.5 × 25 | 12.5 × 25 | 12.5 × 25 16 × 25 |
| 33 | 10 × 16 10 × 20 | 10 × 20 | 12.5 × 20 | 12.5 × 25 | 16 × 20 | 16 × 25 16 × 31.5 |
| 47 | 12.5 × 20 12.5 × 25 | 12.5 × 20 12.5 × 25 | 12.5 × 25 16 × 20 | 16 × 25 | 16 × 25 16 × 31.5 | 16 × 31.5 18 × 31.5 |
| 68 | 12.5 × 25 16 × 20 | 12.5 × 25 16 × 20 | 16 × 25 | 18 × 31.5 | 18 × 31.5 18 × 35 | 18 × 35 |
| 100 | 12.5 × 25 16 × 25 | 16 × 25 | 16 × 31.5 | 18 × 35 20 × 30 | 20 × 35 | 20 × 40 |
| 150 | 16 × 31.5 | 18 × 31.5 | 18 × 40 | 20 × 40 | 20 × 40 | |
| 220 | 16 × 31.5 18 × 31.5 | | 18 × 40 | | | |
| 270 | 18 × 35 18 × 40 | 20 × 35 | 22 × 35 | | | |
| 330 | 18 × 35 20 × 30 | 22 × 35 | 22 × 40 | | | |
| 470 | 22 × 35 | | | | | |
| 560 | 22 × 40 | | | | | |



B41851

Standard series – 105 °C

Technical data and ordering codes – B41851

| C _R 120 Hz 20 °C μF | Case dimensions d × l mm | ESR _{max} 120 Hz 20 °C Ω | ESR _{1max} 10 kHz 20 °C Ω | Z _{max} 100 kHz 20 °C Ω | I _{AC,R} 120 Hz 105 °C mA | I _{AC,max} 120 Hz 85 °C mA | Ordering code (composition see below) |
|---|-----------------------------------|--|---|---|---|--|---|
| V_R = 6.3 V DC | | | | | | | |
| 220 | 6.3 × 11 | 2.1 | 1.6 | 1.5 | 160 | 225 | B41851A2227M*** |
| 270 | 6.3 × 11 | 1.7 | 1.3 | 1.2 | 175 | 245 | B41851A2277M*** |
| 330 | 6.3 × 11 | 1.4 | 1.1 | 1.0 | 195 | 275 | B41851A2337M*** |
| 470 | 8 × 11.5 | 1.0 | 0.77 | 0.71 | 265 | 370 | B41851A2477M*** |
| 560 | 8 × 11.5 | 0.83 | 0.64 | 0.59 | 290 | 405 | B41851A2567M*** |
| 680 | 10 × 12.5 | 0.68 | 0.52 | 0.49 | 360 | 505 | B41851A2687M*** |
| 1000 | 10 × 12.5 | 0.46 | 0.35 | 0.33 | 455 | 635 | B41851A2108M*** |
| 1500 | 10 × 16 | 0.31 | 0.24 | 0.22 | 525 | 735 | B41851F2158M*** |
| 2200 | 10 × 20 | 0.23 | 0.18 | 0.16 | 710 | 995 | B41851A2228M*** |
| 3300 | 10 × 20 | 0.16 | 0.12 | 0.11 | 840 | 1175 | B41851A2338M*** |
| 4700 | 12.5 × 25 | 0.12 | 0.09 | 0.09 | 1120 | 1570 | B41851A2478M*** |
| V_R = 10 V DC | | | | | | | |
| 100 | 5 × 11 | 4.0 | 3.1 | 2.90 | 105 | 150 | B41851A3107M*** |
| 150 | 6.3 × 11 | 2.7 | 2.1 | 1.90 | 115 | 160 | B41851A3157M*** |
| 220 | 6.3 × 11 | 1.8 | 1.4 | 1.30 | 175 | 245 | B41851A3227M*** |
| 270 | 6.3 × 11 | 1.5 | 1.2 | 1.10 | 180 | 250 | B41851A3277M*** |
| 330 | 8 × 11.5 | 1.2 | 0.92 | 0.86 | 220 | 310 | B41851A3337M*** |
| 470 | 8 × 11.5 | 0.85 | 0.65 | 0.61 | 280 | 390 | B41851A3477M*** |
| 560 | 8 × 11.5 | 0.71 | 0.55 | 0.51 | 290 | 405 | B41851B3567M*** |
| 680 | 10 × 12.5 | 0.59 | 0.45 | 0.42 | 330 | 460 | B41851A3687M*** |
| 1000 | 10 × 12.5 | 0.40 | 0.31 | 0.29 | 460 | 645 | B41851A3108M*** |
| 1500 | 10 × 20 | 0.27 | 0.21 | 0.19 | 510 | 715 | B41851A3158M*** |
| 2200 | 10 × 20 | 0.20 | 0.15 | 0.14 | 760 | 1065 | B41851A3228M*** |
| 3300 | 12.5 × 25 | 0.14 | 0.11 | 0.10 | 1085 | 1520 | B41851A3338M*** |
| 4700 | 16 × 20 | 0.11 | 0.08 | 0.08 | 1190 | 1665 | B41851A3478M*** |
| 6800 | 16 × 25 | 0.08 | 0.06 | 0.06 | 1575 | 2205 | B41851F3688M*** |
| 8200 | 16 × 31.5 | 0.08 | 0.06 | 0.06 | 1610 | 2255 | B41851F3828M*** |
| 10000 | 18 × 31.5 | 0.07 | 0.05 | 0.05 | 1820 | 2250 | B41851F3109M*** |

Composition of ordering code

*** = Version

- 000 = for standard leads, bulk
- 001 = for kinked leads, bulk (for Ø ≥ 10 mm)
- 002 = for cut leads, bulk (for Ø ≥ 10 mm)
- 003 = for crimped leads, blister (for Ø ≥ 16 mm)
- 004 = for J leads, blister (from d × l = 10 × 12.5 mm to 18 × 35 mm)
- 008 = for taped leads, Ammo pack, lead spacing F = 5.0 mm (from d × l = 6.3 × 11 mm to 12.5 × 25 mm)
- 009 = for taped leads, Ammo pack, lead spacing F = 7.5 mm (from d × l = 16 × 20 mm to 18 × 31.5 mm)
- 012 = for bent 90° leads, blister (for Ø 16 and 18 mm)

Technical data and ordering codes – B41851

| C_R 120 Hz 20 °C μF | Case dimensions $d \times l$ mm | ESR_{max} 120 Hz 20 °C Ω | $\text{ESR}_{1\text{max}}$ 10 kHz 20 °C Ω | Z_{max} 100 kHz 20 °C Ω | $I_{\text{AC,R}}$ 120 Hz 105 °C mA | $I_{\text{AC,max}}$ 120 Hz 85 °C mA | Ordering code (composition see below) |
|---|--|--|---|--|---|--|---|
| $V_R = 16 \text{ V DC}$ | | | | | | | |
| 68 | 5 × 11 | 4.9 | 3.8 | 3.50 | 70 | 100 | B41851A4686M*** |
| 100 | 5 × 11 | 3.3 | 2.6 | 2.40 | 115 | 160 | B41851A4107M*** |
| 150 | 6.3 × 11 | 2.2 | 1.7 | 1.60 | 125 | 175 | B41851A4157M*** |
| 220 | 6.3 × 11 | 1.5 | 1.2 | 1.10 | 190 | 265 | B41851F4227M*** |
| 270 | 8 × 11.5 | 1.2 | 0.94 | 0.88 | 195 | 275 | B41851A4277M*** |
| 330 | 8 × 11.5 | 1.0 | 0.77 | 0.72 | 265 | 370 | B41851A4337M*** |
| 470 | 8 × 11.5 | 0.71 | 0.54 | 0.50 | 315 | 440 | B41851K4477M*** |
| 560 | 10 × 12.5 | 0.59 | 0.46 | 0.42 | 360 | 505 | B41851A4567M*** |
| 680 | 10 × 12.5 | 0.49 | 0.38 | 0.35 | 390 | 545 | B41851F4687M*** |
| 1000 | 10 × 16 | 0.33 | 0.26 | 0.24 | 560 | 785 | B41851A4108M*** |
| 1500 | 10 × 20 | 0.22 | 0.17 | 0.16 | 650 | 910 | B41851F4158M*** |
| 2200 | 12.5 × 20 | 0.17 | 0.13 | 0.12 | 920 | 1290 | B41851F4228M*** |
| 3300 | 12.5 × 25 | 0.12 | 0.09 | 0.09 | 1170 | 1640 | B41851F4338M*** |
| 3300 | 16 × 25 | 0.12 | 0.09 | 0.09 | 1260 | 1765 | B41851A4338M*** |
| 4700 | 16 × 25 | 0.09 | 0.07 | 0.07 | 1500 | 2100 | B41851A4478M*** |
| 6800 | 16 × 31.5 | 0.07 | 0.06 | 0.05 | 1600 | 2240 | B41851F4688M*** |
| 6800 | 18 × 31.5 | 0.07 | 0.06 | 0.05 | 1680 | 2350 | B41851A4688M*** |
| 8200 | 18 × 31.5 | 0.07 | 0.05 | 0.05 | 1700 | 2380 | B41851F4828M*** |
| 10000 | 18 × 35 | 0.06 | 0.05 | 0.04 | 1950 | 2730 | B41851F4109M*** |
| $V_R = 25 \text{ V DC}$ | | | | | | | |
| 47 | 5 × 11 | 5.6 | 4.3 | 4.0 | 83 | 116 | B41851A5476M*** |
| 100 | 6.3 × 11 | 2.7 | 2.0 | 1.9 | 140 | 195 | B41851A5107M*** |
| 150 | 6.3 × 11 | 1.8 | 1.4 | 1.3 | 145 | 205 | B41851F5157M*** |
| 220 | 8 × 11.5 | 1.2 | 0.93 | 0.86 | 240 | 335 | B41851A5227M*** |
| 270 | 8 × 11.5 | 1.0 | 0.76 | 0.70 | 250 | 350 | B41851A5277M*** |
| 330 | 8 × 11.5 | 0.80 | 0.62 | 0.57 | 310 | 435 | B41851F5337M*** |
| 330 | 10 × 12.5 | 0.80 | 0.62 | 0.57 | 320 | 450 | B41851A5337M*** |
| 470 | 10 × 12.5 | 0.56 | 0.43 | 0.40 | 380 | 530 | B41851F5477M*** |

Composition of ordering code

*** = Version

000 = for standard leads, bulk

 001 = for kinked leads, bulk (for $\varnothing \geq 10 \text{ mm}$)

 002 = for cut leads, bulk (for $\varnothing \geq 10 \text{ mm}$)

 003 = for crimped leads, blister (for $\varnothing \geq 16 \text{ mm}$)

 004 = for J leads, blister (from $d \times l = 10 \times 12.5 \text{ mm}$ to $18 \times 35 \text{ mm}$)

 008 = for taped leads, Ammo pack, lead spacing $F = 5.0 \text{ mm}$ (from $d \times l = 6.3 \times 11 \text{ mm}$ to $12.5 \times 25 \text{ mm}$)

 009 = for taped leads, Ammo pack, lead spacing $F = 7.5 \text{ mm}$ (from $d \times l = 16 \times 20 \text{ mm}$ to $18 \times 31.5 \text{ mm}$)

 012 = for bent 90° leads, blister (for $\varnothing 16$ and 18 mm)

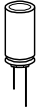

B41851

Standard series – 105 °C

Technical data and ordering codes – B41851

| C _R 120 Hz 20 °C μF | Case dimensions d × l mm | ESR _{max} 120 Hz 20 °C Ω | ESR _{1max} 10 kHz 20 °C Ω | Z _{max} 100 kHz 20 °C Ω | I _{AC,R} 120 Hz 105 °C mA | I _{AC,max} 120 Hz 85 °C mA | Ordering code (composition see below) |
|---|-----------------------------------|--|---|---|---|--|---|
| V_R = 25 V DC | | | | | | | |
| 560 | 10 × 16 | 0.47 | 0.36 | 0.34 | 400 | 560 | B41851A5567M*** |
| 680 | 10 × 16 | 0.39 | 0.30 | 0.28 | 440 | 615 | B41851F5687M*** |
| 1000 | 10 × 20 | 0.27 | 0.20 | 0.19 | 680 | 950 | B41851A5108M*** |
| 1500 | 12.5 × 20 | 0.18 | 0.14 | 0.13 | 770 | 1080 | B41851F5158M*** |
| 2200 | 12.5 × 25 | 0.14 | 0.10 | 0.10 | 1090 | 1525 | B41851F5228M*** |
| 3300 | 16 × 25 | 0.10 | 0.08 | 0.07 | 1400 | 1960 | B41851A5338M*** |
| 4700 | 16 × 31.5 | 0.08 | 0.06 | 0.06 | 1700 | 2380 | B41851A5478M*** |
| 6800 | 18 × 35 | 0.06 | 0.05 | 0.05 | 1850 | 2590 | B41851F5688M*** |
| 8200 | 18 × 40 | 0.06 | 0.05 | 0.04 | 1900 | 2660 | B41851F5828M*** |
| 10000 | 20 × 40 | 0.06 | 0.04 | 0.04 | 2050 | 2870 | B41851F5109M*** |
| V_R = 35 V DC | | | | | | | |
| 33 | 5 × 11 | 7.0 | 5.40 | 5.0 | 75 | 105 | B41851A7336M*** |
| 47 | 5 × 11 | 4.9 | 3.80 | 3.5 | 93 | 130 | B41851A7476M*** |
| 68 | 6.3 × 11 | 3.4 | 2.60 | 2.4 | 110 | 155 | B41851A7686M*** |
| 100 | 6.3 × 11 | 2.3 | 1.80 | 1.7 | 150 | 210 | B41851F7107M*** |
| 150 | 8 × 11.5 | 1.5 | 1.20 | 1.1 | 210 | 295 | B41851A7157M*** |
| 220 | 8 × 11.5 | 1.1 | 0.81 | 0.75 | 270 | 380 | B41851F7227M*** |
| 270 | 10 × 12.5 | 0.86 | 0.66 | 0.61 | 300 | 420 | B41851A7277M*** |
| 330 | 10 × 12.5 | 0.70 | 0.54 | 0.50 | 350 | 490 | B41851A7337M*** |
| 470 | 10 × 16 | 0.49 | 0.38 | 0.35 | 460 | 645 | B41851A7477M*** |
| 560 | 10 × 20 | 0.41 | 0.32 | 0.30 | 540 | 755 | B41851A7567M*** |
| 680 | 10 × 20 | 0.34 | 0.26 | 0.24 | 590 | 825 | B41851A7687M*** |
| 1000 | 12.5 × 20 | 0.23 | 0.18 | 0.17 | 810 | 1135 | B41851F7108M*** |
| 1500 | 16 × 20 | 0.15 | 0.12 | 0.11 | 980 | 1370 | B41851F7158M*** |
| 2200 | 16 × 25 | 0.12 | 0.09 | 0.09 | 1260 | 1765 | B41851F7228M*** |
| 3300 | 16 × 31.5 | 0.09 | 0.07 | 0.06 | 1500 | 2100 | B41851F7338M*** |
| 4700 | 18 × 35 | 0.07 | 0.05 | 0.05 | 1780 | 2490 | B41851K7478M*** |
| 6800 | 18 × 40 | 0.06 | 0.05 | 0.04 | 2000 | 2800 | B41851K7688M*** |

Composition of ordering code

*** = Version

000 = for standard leads, bulk

001 = for kinked leads, bulk (for Ø ≥ 10 mm)

002 = for cut leads, bulk (for Ø ≥ 10 mm)

003 = for crimped leads, blister (for Ø ≥ 16 mm)

004 = for J leads, blister (from d × l = 10 × 12.5 mm to 18 × 35 mm)

008 = for taped leads, Ammo pack, lead spacing F = 5.0 mm (from d × l = 6.3 × 11 mm to 12.5 × 25 mm)

009 = for taped leads, Ammo pack, lead spacing F = 7.5 mm (from d × l = 16 × 20 mm to 18 × 31.5 mm)

012 = for bent 90° leads, blister (for Ø 16 and 18 mm)

Technical data and ordering codes – B41851

| C_R 120 Hz 20 °C μF | Case dimensions $d \times l$ mm | ESR_{max} 120 Hz 20 °C Ω | $\text{ESR}_{1\text{max}}$ 10 kHz 20 °C Ω | Z_{max} 100 kHz 20 °C Ω | $I_{\text{AC,R}}$ 120 Hz 105 °C mA | $I_{\text{AC,max}}$ 120 Hz 85 °C mA | Ordering code (composition see below) |
|---|--|--|---|--|---|--|---|
| $V_R = 50 \text{ V DC}$ | | | | | | | |
| 1 | 5 × 11 | 199 | 153 | 142 | 13 | 18 | B41851A6105M*** |
| 2.2 | 5 × 11 | 90 | 69 | 64 | 20 | 28 | B41851A6225M*** |
| 3.3 | 5 × 11 | 60 | 46 | 43 | 25 | 35 | B41851A6335M*** |
| 4.7 | 5 × 11 | 42 | 32 | 30 | 30 | 42 | B41851A6475M*** |
| 10 | 5 × 11 | 20 | 15 | 14 | 46 | 65 | B41851A6106M*** |
| 22 | 5 × 11 | 9.0 | 7.0 | 6.5 | 67 | 94 | B41851A6226M*** |
| 33 | 6.3 × 11 | 6.0 | 4.6 | 4.3 | 90 | 126 | B41851A6336M*** |
| 47 | 6.3 × 11 | 4.2 | 3.3 | 3.0 | 115 | 160 | B41851A6476M*** |
| 68 | 6.3 × 11 | 2.9 | 2.3 | 2.1 | 150 | 210 | B41851F6686M*** |
| 100 | 8 × 11.5 | 2.0 | 1.5 | 1.4 | 190 | 265 | B41851A6107M*** |
| 150 | 8 × 11.5 | 1.3 | 1.0 | 0.95 | 210 | 295 | B41851F6157M*** |
| 220 | 10 × 12.5 | 0.90 | 0.70 | 0.65 | 300 | 420 | B41851A6227M*** |
| 270 | 10 × 16 | 0.74 | 0.57 | 0.53 | 360 | 505 | B41851A6277M*** |
| 330 | 10 × 16 | 0.60 | 0.46 | 0.43 | 410 | 575 | B41851A6337M*** |
| 470 | 10 × 20 | 0.42 | 0.33 | 0.30 | 540 | 755 | B41851A6477M*** |
| 560 | 12.5 × 20 | 0.36 | 0.27 | 0.25 | 651 | 910 | B41851F6567M*** |
| 680 | 12.5 × 20 | 0.29 | 0.23 | 0.21 | 700 | 980 | B41851F6687M*** |
| 1000 | 12.5 × 25 | 0.20 | 0.15 | 0.14 | 950 | 1330 | B41851F6108M*** |
| 1500 | 16 × 25 | 0.13 | 0.10 | 0.09 | 1260 | 1765 | B41851F6158M*** |
| 2200 | 16 × 31.5 | 0.11 | 0.08 | 0.08 | 1410 | 1975 | B41851F6228M*** |
| 2200 | 18 × 35 | 0.11 | 0.08 | 0.08 | 1540 | 2155 | B41851A6228M*** |
| 3300 | 18 × 35 | 0.08 | 0.06 | 0.06 | 1770 | 2480 | B41851K6338M*** |
| 4700 | 20 × 40 | 0.06 | 0.05 | 0.05 | 2100 | 2940 | B41851K6478M*** |

Composition of ordering code

*** = Version

000 = for standard leads, bulk

 001 = for kinked leads, bulk (for $\varnothing \geq 10 \text{ mm}$)

 002 = for cut leads, bulk (for $\varnothing \geq 10 \text{ mm}$)

 003 = for crimped leads, blister (for $\varnothing \geq 16 \text{ mm}$)

 004 = for J leads, blister (from $d \times l = 10 \times 12.5 \text{ mm}$ to $18 \times 35 \text{ mm}$)

 008 = for taped leads, Ammo pack, lead spacing $F = 5.0 \text{ mm}$ (from $d \times l = 6.3 \times 11 \text{ mm}$ to $12.5 \times 25 \text{ mm}$)

 009 = for taped leads, Ammo pack, lead spacing $F = 7.5 \text{ mm}$ (from $d \times l = 16 \times 20 \text{ mm}$ to $18 \times 31.5 \text{ mm}$)

 012 = for bent 90° leads, blister (for $\varnothing 16$ and 18 mm)



B41851

Standard series – 105 °C

Technical data and ordering codes – B41851

| C_R 120 Hz 20 °C μF | Case dimensions $d \times l$ mm | ESR_{max} 120 Hz 20 °C Ω | $\text{ESR}_{1\text{max}}$ 10 kHz 20 °C Ω | Z_{max} 100 kHz 20 °C Ω | $I_{\text{AC,R}}$ 120 Hz 105 °C mA | $I_{\text{AC,max}}$ 120 Hz 85 °C mA | Ordering code (composition see below) |
|---|--|--|---|--|---|--|---|
| $V_R = 63 \text{ V DC}$ | | | | | | | |
| 6.8 | 5 × 11 | 29 | 23 | 21 | 35 | 50 | B41851A8685M*** |
| 10 | 5 × 11 | 20 | 15 | 14 | 46 | 65 | B41851A8106M*** |
| 22 | 5 × 11 | 9.0 | 7.0 | 6.5 | 70 | 100 | B41851F8226M*** |
| 22 | 6.3 × 11 | 9.0 | 7.0 | 6.5 | 77 | 110 | B41851A8226M*** |
| 33 | 6.3 × 11 | 6.0 | 4.6 | 4.3 | 100 | 140 | B41851A8336M*** |
| 47 | 6.3 × 11 | 4.2 | 3.3 | 3.0 | 120 | 170 | B41851F8476M*** |
| 47 | 8 × 11.5 | 4.2 | 3.3 | 3.0 | 130 | 185 | B41851A8476M*** |
| 68 | 8 × 11.5 | 2.9 | 2.3 | 2.1 | 155 | 220 | B41851F8686M*** |
| 100 | 8 × 11.5 | 2.0 | 1.5 | 1.4 | 200 | 280 | B41851F8107M*** |
| 150 | 10 × 12.5 | 1.3 | 1.0 | 0.95 | 250 | 350 | B41851F8157M*** |
| 220 | 10 × 16 | 0.90 | 0.70 | 0.65 | 335 | 470 | B41851A8227M*** |
| 270 | 10 × 20 | 0.74 | 0.57 | 0.53 | 410 | 575 | B41851A8277M*** |
| 330 | 10 × 20 | 0.60 | 0.46 | 0.43 | 510 | 715 | B41851A8337M*** |
| 470 | 12.5 × 20 | 0.42 | 0.33 | 0.30 | 640 | 895 | B41851F8477M*** |
| 470 | 12.5 × 25 | 0.42 | 0.33 | 0.30 | 655 | 920 | B41851A8477M*** |
| 560 | 12.5 × 25 | 0.36 | 0.27 | 0.25 | 700 | 980 | B41851F8567M*** |
| 680 | 16 × 20 | 0.29 | 0.23 | 0.21 | 770 | 1080 | B41851F8687M*** |
| 1000 | 16 × 25 | 0.20 | 0.15 | 0.14 | 930 | 1300 | B41851F8108M*** |
| 1000 | 16 × 31.5 | 0.20 | 0.15 | 0.14 | 980 | 1375 | B41851A8108M*** |
| 1500 | 18 × 31.5 | 0.13 | 0.10 | 0.09 | 1260 | 1765 | B41851F8158M*** |
| 2200 | 18 × 35 | 0.11 | 0.08 | 0.08 | 1650 | 2310 | B41851A8228M*** |
| 2200 | 18 × 40 | 0.11 | 0.08 | 0.08 | 1650 | 2310 | B41851F8228M*** |
| 3300 | 20 × 40 | 0.08 | 0.06 | 0.06 | 1950 | 2730 | B41851A8338M*** |
| 4700 | 25 × 40 | 0.06 | 0.05 | 0.05 | 2250 | 3150 | B41851F8478M*** |

Composition of ordering code

*** = Version

000 = for standard leads, bulk

001 = for kinked leads, bulk (for $\varnothing \geq 10 \text{ mm}$)

002 = for cut leads, bulk (for $\varnothing \geq 10 \text{ mm}$)

003 = for crimped leads, blister (for $\varnothing \geq 16 \text{ mm}$)

004 = for J leads, blister (from $d \times l = 10 \times 12.5 \text{ mm}$ to $18 \times 35 \text{ mm}$)

008 = for taped leads, Ammo pack, lead spacing $F = 5.0 \text{ mm}$ (from $d \times l = 6.3 \times 11 \text{ mm}$ to $12.5 \times 25 \text{ mm}$)

009 = for taped leads, Ammo pack, lead spacing $F = 7.5 \text{ mm}$ (from $d \times l = 16 \times 20 \text{ mm}$ to $18 \times 31.5 \text{ mm}$)

012 = for bent 90° leads, blister (for $\varnothing 16$ and 18 mm)

Technical data and ordering codes – B41851

| C_R 120 Hz 20 °C μF | Case dimensions $d \times l$ mm | ESR_{max} 120 Hz 20 °C Ω | $\text{ESR}_{1\text{max}}$ 10 kHz 20 °C Ω | Z_{max} 100 kHz 20 °C Ω | $I_{\text{AC,R}}$ 120 Hz 105 °C mA | $I_{\text{AC,max}}$ 120 Hz 85 °C mA | Ordering code (composition see below) |
|--|--|--|---|--|---|--|---|
| $V_R = 100 \text{ V DC}$ | | | | | | | |
| 0.1 | 5 × 11 | 1658 | 1275 | 1184 | 1.5 | 2.1 | B41851A9104M*** |
| 0.22 | 5 × 11 | 754 | 580 | 538 | 3.4 | 4.8 | B41851A9224M*** |
| 0.33 | 5 × 11 | 502 | 386 | 359 | 5.0 | 7.0 | B41851A9334M*** |
| 0.47 | 5 × 11 | 353 | 271 | 252 | 7.1 | 10 | B41851A9474M*** |
| 0.68 | 5 × 11 | 244 | 188 | 174 | 9.1 | 13 | B41851A9684M*** |
| 1 | 5 × 11 | 166 | 128 | 118 | 15 | 21 | B41851A9105M*** |
| 1.5 | 5 × 11 | 111 | 85 | 79 | 17 | 24 | B41851A9155M*** |
| 2.2 | 5 × 11 | 75 | 58 | 54 | 21 | 30 | B41851A9225M*** |
| 3.3 | 5 × 11 | 50 | 39 | 36 | 29 | 41 | B41851A9335M*** |
| 4.7 | 5 × 11 | 35 | 27 | 25 | 32 | 45 | B41851A9475M*** |
| 10 | 6.3 × 11 | 17 | 13 | 12 | 53 | 74 | B41851A9106M*** |
| 22 | 8 × 11.5 | 7.5 | 5.8 | 5.4 | 98 | 137 | B41851A9226M*** |
| 33 | 10 × 12.5 | 5.0 | 3.9 | 3.6 | 135 | 190 | B41851A9336M*** |
| 47 | 10 × 12.5 | 3.5 | 2.7 | 2.5 | 160 | 225 | B41851B9476M*** |
| 68 | 10 × 16 | 2.4 | 1.9 | 1.7 | 195 | 275 | B41851A9686M*** |
| 100 | 10 × 20 | 1.7 | 1.3 | 1.2 | 245 | 345 | B41851A9107M*** |
| 150 | 12.5 × 25 | 1.1 | 0.85 | 0.79 | 385 | 540 | B41851A9157M*** |
| 220 | 12.5 × 25 | 0.75 | 0.58 | 0.54 | 435 | 610 | B41851A9227M*** |
| 270 | 16 × 25 | 0.61 | 0.47 | 0.44 | 540 | 755 | B41851A9277M*** |
| 330 | 16 × 25 | 0.50 | 0.39 | 0.36 | 560 | 785 | B41851A9337M*** |
| 470 | 16 × 31.5 | 0.35 | 0.27 | 0.25 | 700 | 980 | B41851A9477M*** |
| 560 | 16 × 31.5 | 0.30 | 0.23 | 0.21 | 735 | 1030 | B41851A9567M*** |
| 680 | 18 × 40 | 0.24 | 0.19 | 0.17 | 770 | 1080 | B41851F9687M*** |
| 1000 | 20 × 40 | 0.17 | 0.13 | 0.12 | 980 | 1370 | B41851A9108M*** |

Composition of ordering code

*** = Version

000 = for standard leads, bulk

 001 = for kinked leads, bulk (for $\varnothing \geq 10 \text{ mm}$)

 002 = for cut leads, bulk (for $\varnothing \geq 10 \text{ mm}$)

 003 = for crimped leads, blister (for $\varnothing \geq 16 \text{ mm}$)

 004 = for J leads, blister (from $d \times l = 10 \times 12.5 \text{ mm}$ to $18 \times 35 \text{ mm}$)

 008 = for taped leads, Ammo pack, lead spacing $F = 5.0 \text{ mm}$ (from $d \times l = 6.3 \times 11 \text{ mm}$ to $12.5 \times 25 \text{ mm}$)

 009 = for taped leads, Ammo pack, lead spacing $F = 7.5 \text{ mm}$ (from $d \times l = 16 \times 20 \text{ mm}$ to $18 \times 31.5 \text{ mm}$)

 012 = for bent 90° leads, blister (for $\varnothing 16$ and 18 mm)

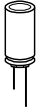
**B43851****Standard series – 105 °C****Technical data and ordering codes – B43851**

| C _R 120 Hz 20 °C μF | Case dimensions d × l mm | ESR _{max} 120 Hz 20 °C Ω | ESR _{max} 10 kHz 20 °C Ω | Z _{max} 100 kHz 20 °C Ω | I _{AC,R} 120 Hz 105 °C mA | I _{AC,max} 120 Hz 85 °C mA | Ordering code (composition see below) |
|---|-----------------------------------|--|--|---|---|--|---|
| V_R = 160 V DC | | | | | | | |
| 0.47 | 6.3 × 11 | 395 | 296 | 158 | 11 | 19 | B43851A1474M*** |
| 0.68 | 6.3 × 11 | 273 | 205 | 109 | 13 | 22 | B43851A1684M*** |
| 1 | 6.3 × 11 | 186 | 139 | 74 | 16 | 27 | B43851A1105M*** |
| 1.5 | 6.3 × 11 | 124 | 93 | 50 | 21 | 36 | B43851A1155M*** |
| 2.2 | 6.3 × 11 | 85 | 63 | 34 | 23 | 39 | B43851A1225M*** |
| 3.3 | 6.3 × 11 | 56 | 42 | 22 | 28 | 48 | B43851A1335M*** |
| 4.7 | 6.3 × 11 | 40 | 30 | 16 | 35 | 60 | B43851F1475M*** |
| 6.8 | 8 × 11.5 | 27 | 21 | 11 | 46 | 78 | B43851A1685M*** |
| 10 | 8 × 11.5 | 18 | 14 | 7.4 | 56 | 95 | B43851F1106M*** |
| 22 | 10 × 12.5 | 13 | 9.5 | 5.0 | 91 | 155 | B43851F1226M*** |
| 22 | 10 × 16 | 8.4 | 6.3 | 3.4 | 108 | 184 | B43851A1226M*** |
| 33 | 10 × 16 | 7.5 | 5.6 | 3.0 | 125 | 213 | B43851F1336M*** |
| 33 | 10 × 20 | 5.6 | 4.2 | 2.2 | 143 | 243 | B43851A1336M*** |
| 47 | 12.5 × 20 | 4.5 | 3.4 | 1.8 | 188 | 320 | B43851F1476M*** |
| 47 | 12.5 × 25 | 4.0 | 3.0 | 1.6 | 203 | 345 | B43851A1476M*** |
| 68 | 12.5 × 25 | 2.7 | 2.1 | 1.1 | 245 | 417 | B43851F1686M*** |
| 68 | 16 × 20 | 2.7 | 2.1 | 1.1 | 255 | 434 | B43851A1686M*** |
| 100 | 12.5 × 25 | 2.3 | 1.7 | 0.92 | 300 | 510 | B43851F1107M*** |
| 100 | 16 × 25 | 1.8 | 1.4 | 0.74 | 332 | 564 | B43851A1107M*** |
| 150 | 16 × 31.5 | 1.2 | 0.92 | 0.49 | 420 | 714 | B43851A1157M*** |
| 220 | 16 × 31.5 | 0.95 | 0.71 | 0.38 | 532 | 904 | B43851F1227M*** |
| 220 | 18 × 31.5 | 0.84 | 0.63 | 0.34 | 560 | 952 | B43851A1227M*** |
| 270 | 18 × 35 | 0.75 | 0.56 | 0.30 | 630 | 1071 | B43851F1277M*** |
| 270 | 18 × 40 | 0.67 | 0.50 | 0.27 | 665 | 1131 | B43851A1277M*** |
| 330 | 18 × 35 | 0.70 | 0.53 | 0.28 | 695 | 1182 | B43851F1337M*** |
| 330 | 20 × 30 | 0.56 | 0.42 | 0.22 | 700 | 1190 | B43851A1337M*** |
| 470 | 22 × 35 | 0.40 | 0.30 | 0.16 | 910 | 1547 | B43851A1477M*** |
| 560 | 22 × 40 | 0.33 | 0.25 | 0.13 | 1050 | 1785 | B43851A1567M*** |

Composition of ordering code

*** = Version

000 = for standard leads, bulk

001 = for kinked leads, bulk (for Ø ≥ 10 mm)

002 = for cut leads, bulk (for Ø ≥ 10 mm)

003 = for crimped leads, blister (for Ø ≥ 16 mm)

004 = for J leads, blister (from d × l = 10 × 12.5 mm to 18 × 35 mm)

008 = for taped leads, Ammo pack, lead spacing F = 5.0 mm (from d × l = 6.3 × 11 mm to 12.5 × 25 mm)

009 = for taped leads, Ammo pack, lead spacing F = 7.5 mm (from d × l = 16 × 20 mm to 18 × 31.5 mm)

012 = for bent 90° leads, blister (for Ø 16 and 18 mm)

Technical data and ordering codes – B43851

| C_R | Case | ESR_{max} | ESR_{max} | Z_{max} | $I_{AC,R}$ | $I_{AC,max}$ | Ordering code |
|------------------------------------|--------------|-------------|-------------|-----------|------------|--------------|------------------|
| 120 Hz | dimensions | 120 Hz | 10 kHz | 100 kHz | 120 Hz | 120 Hz | (composition see |
| 20 °C | $d \times l$ | 20 °C | 20 °C | 20 °C | 105 °C | 85 °C | below) |
| μF | mm | Ω | Ω | Ω | mA | mA | |
| $V_R = 200$ V DC | | | | | | | |
| 0.47 | 6.3 × 11 | 395 | 296 | 158 | 11 | 19 | B43851A2474M*** |
| 0.68 | 6.3 × 11 | 273 | 205 | 109 | 13 | 22 | B43851A2684M*** |
| 1 | 6.3 × 11 | 186 | 139 | 74 | 16 | 27 | B43851A2105M*** |
| 1.5 | 6.3 × 11 | 124 | 93 | 50 | 21 | 36 | B43851A2155M*** |
| 2.2 | 6.3 × 11 | 85 | 63 | 34 | 23 | 39 | B43851A2225M*** |
| 3.3 | 6.3 × 11 | 56 | 42 | 22 | 28 | 48 | B43851A2335M*** |
| 4.7 | 8 × 11.5 | 40 | 30 | 16 | 38 | 65 | B43851A2475M*** |
| 6.8 | 10 × 12.5 | 27 | 21 | 11 | 55 | 94 | B43851A2685M*** |
| 10 | 10 × 12.5 | 18 | 14 | 7.4 | 66 | 112 | B43851B2106M*** |
| 22 | 10 × 16 | 8.4 | 6.3 | 3.4 | 108 | 184 | B43851K2226M*** |
| 22 | 10 × 20 | 8.4 | 6.3 | 3.4 | 120 | 204 | B43851A2226M*** |
| 33 | 10 × 20 | 5.6 | 4.2 | 2.2 | 144 | 245 | B43851B2336M*** |
| 47 | 12.5 × 20 | 4.5 | 3.4 | 1.8 | 190 | 323 | B43851K2476M*** |
| 47 | 12.5 × 25 | 4.0 | 3.0 | 1.6 | 203 | 345 | B43851A2476M*** |
| 68 | 12.5 × 25 | 3.3 | 2.5 | 1.3 | 245 | 417 | B43851K2686M*** |
| 68 | 16 × 20 | 3.3 | 2.5 | 1.3 | 255 | 434 | B43851A2686M*** |
| 100 | 16 × 25 | 1.8 | 1.4 | 0.74 | 332 | 564 | B43851A2107M*** |
| 150 | 18 × 31.5 | 1.2 | 0.92 | 0.49 | 448 | 762 | B43851A2157M*** |
| 220 | 18 × 35 | 0.84 | 0.63 | 0.34 | 539 | 916 | B43851A2227M*** |
| 270 | 20 × 35 | 0.67 | 0.50 | 0.27 | 637 | 1083 | B43851A2277M*** |
| 330 | 22 × 35 | 0.56 | 0.42 | 0.22 | 742 | 1261 | B43851A2337M*** |

Composition of ordering code

*** = Version

000 = for standard leads, bulk

 001 = for kinked leads, bulk (for $\varnothing \geq 10$ mm)

 002 = for cut leads, bulk (for $\varnothing \geq 10$ mm)

 003 = for crimped leads, blister (for $\varnothing \geq 16$ mm)

 004 = for J leads, blister (from $d \times l = 10 \times 12.5$ mm to 18×35 mm)

 008 = for taped leads, Ammo pack, lead spacing $F = 5.0$ mm (from $d \times l = 6.3 \times 11$ mm to 12.5×25 mm)

 009 = for taped leads, Ammo pack, lead spacing $F = 7.5$ mm (from $d \times l = 16 \times 20$ mm to 18×31.5 mm)

 012 = for bent 90° leads, blister (for $\varnothing 16$ and 18 mm)



B43851

Standard series – 105 °C

Technical data and ordering codes – B43851

| C_R | Case | ESR_{max} | ESR_{max} | Z_{max} | $I_{AC,R}$ | $I_{AC,max}$ | Ordering code |
|------------------------------------|--------------|-------------|-------------|-----------|------------|--------------|------------------|
| 120 Hz | dimensions | 120 Hz | 10 kHz | 100 kHz | 120 Hz | 120 Hz | (composition see |
| 20 °C | $d \times l$ | 20 °C | 20 °C | 20 °C | 105 °C | 85 °C | below) |
| μF | mm | Ω | Ω | Ω | mA | mA | |
| $V_R = 250 V$ DC | | | | | | | |
| 0.47 | 6.3 × 11 | 395 | 296 | 158 | 11 | 19 | B43851F2474M*** |
| 0.68 | 6.3 × 11 | 273 | 205 | 109 | 13 | 22 | B43851F2684M*** |
| 1 | 6.3 × 11 | 186 | 139 | 74 | 16 | 27 | B43851F2105M*** |
| 1.5 | 6.3 × 11 | 124 | 93 | 50 | 21 | 36 | B43851F2155M*** |
| 2.2 | 6.3 × 11 | 85 | 63 | 34 | 23 | 39 | B43851F2225M*** |
| 3.3 | 8 × 11.5 | 56 | 42 | 22 | 35 | 60 | B43851F2335M*** |
| 4.7 | 8 × 11.5 | 40 | 30 | 16 | 38 | 65 | B43851K2475M*** |
| 6.8 | 10 × 12.5 | 27 | 21 | 11 | 55 | 94 | B43851F2685M*** |
| 10 | 10 × 12.5 | 23 | 17 | 9.0 | 66 | 112 | B43851K2106M*** |
| 10 | 10 × 16 | 18 | 14 | 7.4 | 74 | 126 | B43851F2106M*** |
| 22 | 10 × 20 | 8.4 | 6.3 | 3.4 | 120 | 204 | B43851F2226M*** |
| 33 | 12.5 × 20 | 5.6 | 4.2 | 2.2 | 161 | 274 | B43851K2336M*** |
| 47 | 12.5 × 25 | 4.3 | 3.2 | 1.7 | 203 | 345 | B43851G2476M*** |
| 47 | 16 × 20 | 4.0 | 3.0 | 1.6 | 210 | 357 | B43851F2476M*** |
| 68 | 16 × 25 | 2.7 | 2.1 | 1.1 | 266 | 452 | B43851F2686M*** |
| 100 | 16 × 31.5 | 1.8 | 1.4 | 0.74 | 364 | 619 | B43851K2107M*** |
| 150 | 18 × 40 | 1.2 | 0.92 | 0.49 | 430 | 731 | B43851F2157M*** |
| 220 | 18 × 40 | 0.84 | 0.63 | 0.34 | 476 | 809 | B43851F2227M*** |
| 270 | 22 × 35 | 0.67 | 0.50 | 0.27 | 567 | 964 | B43851F2277M*** |
| 330 | 22 × 40 | 0.56 | 0.42 | 0.22 | 658 | 1119 | B43851F2337M*** |

Composition of ordering code

*** = Version

000 = for standard leads, bulk

001 = for kinked leads, bulk (for $\varnothing \geq 10$ mm)

002 = for cut leads, bulk (for $\varnothing \geq 10$ mm)

003 = for crimped leads, blister (for $\varnothing \geq 16$ mm)

004 = for J leads, blister (from $d \times l = 10 \times 12.5$ mm to 18×35 mm)

008 = for taped leads, Ammo pack, lead spacing $F = 5.0$ mm (from $d \times l = 6.3 \times 11$ mm to 12.5×25 mm)

009 = for taped leads, Ammo pack, lead spacing $F = 7.5$ mm (from $d \times l = 16 \times 20$ mm to 18×31.5 mm)

012 = for bent 90° leads, blister (for $\varnothing 16$ and 18 mm)

Technical data and ordering codes – B43851

| C_R | Case dimensions | ESR_{max} 120 Hz 20 °C | ESR_{max} 10 kHz 20 °C | Z_{max} 100 kHz 20 °C | $I_{AC,R}$ 120 Hz 105 °C | $I_{AC,max}$ 120 Hz 85 °C | Ordering code (composition see below) |
|------------------------------------|-----------------|--------------------------------|--------------------------------|-------------------------------|--------------------------------|---------------------------------|--|
| μF | d × l mm | Ω | Ω | Ω | mA | mA | |
| $V_R = 350 V DC$ | | | | | | | |
| 0.47 | 6.3 × 11 | 395 | 296 | 158 | 10 | 17 | B43851A4474M*** |
| 0.68 | 6.3 × 11 | 273 | 205 | 109 | 12 | 20 | B43851A4684M*** |
| 1 | 6.3 × 11 | 186 | 139 | 74 | 15 | 26 | B43851A4105M*** |
| 1.5 | 8 × 11.5 | 124 | 93 | 50 | 22 | 37 | B43851A4155M*** |
| 2.2 | 8 × 11.5 | 85 | 63 | 34 | 26 | 44 | B43851A4225M*** |
| 3.3 | 10 × 12.5 | 56 | 42 | 22 | 38 | 65 | B43851A4335M*** |
| 4.7 | 10 × 12.5 | 40 | 30 | 16 | 45 | 77 | B43851A4475M*** |
| 6.8 | 10 × 16 | 27 | 21 | 11 | 60 | 102 | B43851A4685M*** |
| 10 | 10 × 20 | 18 | 14 | 7.4 | 81 | 138 | B43851A4106M*** |
| 22 | 12.5 × 25 | 8.4 | 6.3 | 3.4 | 140 | 238 | B43851A4226M*** |
| 33 | 12.5 × 25 | 5.6 | 4.2 | 2.2 | 168 | 286 | B43851F4336M*** |
| 47 | 16 × 25 | 4.0 | 3.0 | 1.6 | 210 | 357 | B43851F4476M*** |
| 68 | 18 × 31.5 | 2.7 | 2.1 | 1.1 | 294 | 500 | B43851A4686M*** |
| 100 | 18 × 35 | 2.3 | 1.7 | 0.90 | 364 | 619 | B43851F4107M*** |
| 100 | 20 × 30 | 1.8 | 1.4 | 0.74 | 371 | 631 | B43851A4107M*** |
| 150 | 20 × 40 | 1.2 | 0.92 | 0.49 | 490 | 833 | B43851A4157M*** |

Composition of ordering code

*** = Version

000 = for standard leads, bulk

 001 = for kinked leads, bulk (for $\varnothing \geq 10$ mm)

 002 = for cut leads, bulk (for $\varnothing \geq 10$ mm)

 003 = for crimped leads, blister (for $\varnothing \geq 16$ mm)

 004 = for J leads, blister (from $d \times l = 10 \times 12.5$ mm to 18×35 mm)

 008 = for taped leads, Ammo pack, lead spacing $F = 5.0$ mm (from $d \times l = 6.3 \times 11$ mm to 12.5×25 mm)

 009 = for taped leads, Ammo pack, lead spacing $F = 7.5$ mm (from $d \times l = 16 \times 20$ mm to 18×31.5 mm)

 012 = for bent 90° leads, blister (for \varnothing 16 and 18 mm)

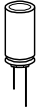

B43851

Standard series – 105 °C

Technical data and ordering codes – B43851

| C_R 120 Hz 20 °C μF | Case dimensions $d \times l$ mm | ESR_{max} 120 Hz 20 °C Ω | ESR_{max} 10 kHz 20 °C Ω | Z_{max} 100 kHz 20 °C Ω | $I_{AC,R}$ 120 Hz 105 °C mA | $I_{AC,max}$ 120 Hz 85 °C mA | Ordering code (composition see below) |
|------------------------------------|--|-------------------------------------|-------------------------------------|------------------------------------|--------------------------------------|---------------------------------------|---|
| $V_R = 400 V$ DC | | | | | | | |
| 2.2 | 10 × 12.5 | 85 | 63 | 34 | 32 | 54 | B43851A9225M*** |
| 3.3 | 10 × 12.5 | 56 | 42 | 22 | 38 | 65 | B43851A9335M*** |
| 4.7 | 10 × 16 | 40 | 30 | 16 | 49 | 83 | B43851A9475M*** |
| 6.8 | 10 × 16 | 27 | 21 | 11 | 60 | 102 | B43851A9685M*** |
| 10 | 10 × 20 | 18 | 14 | 7.4 | 80 | 136 | B43851A9106M*** |
| 22 | 12.5 × 25 | 8.4 | 6.3 | 3.4 | 140 | 238 | B43851F9226M*** |
| 33 | 16 × 20 | 5.6 | 4.2 | 2.2 | 168 | 286 | B43851F9336M*** |
| 47 | 16 × 25 | 4.0 | 3.0 | 1.6 | 196 | 333 | B43851F9476M*** |
| 47 | 16 × 31.5 | 4.0 | 3.0 | 1.6 | 210 | 357 | B43851A9476M*** |
| 68 | 18 × 31.5 | 3.3 | 2.4 | 1.3 | 294 | 500 | B43851F9686M*** |
| 68 | 18 × 35 | 2.7 | 2.1 | 1.1 | 310 | 527 | B43851A9686M*** |
| 100 | 20 × 35 | 1.8 | 1.4 | 0.74 | 322 | 547 | B43851A9107M*** |
| 150 | 20 × 40 | 1.2 | 0.92 | 0.49 | 420 | 714 | B43851A9157M*** |
| $V_R = 450 V$ DC | | | | | | | |
| 2.2 | 10 × 12.5 | 85 | 63 | 34 | 24 | 41 | B43851A5225M*** |
| 3.3 | 10 × 16 | 56 | 42 | 22 | 32 | 54 | B43851A5335M*** |
| 4.7 | 10 × 16 | 40 | 30 | 16 | 35 | 60 | B43851F5475M*** |
| 4.7 | 10 × 20 | 40 | 30 | 16 | 40 | 68 | B43851A5475M*** |
| 6.8 | 10 × 20 | 27 | 21 | 11 | 53 | 90 | B43851A5685M*** |
| 10 | 10 × 20 | 26 | 19 | 10 | 56 | 95 | B43851F5106M*** |
| 10 | 12.5 × 25 | 18 | 14 | 7.4 | 63 | 107 | B43851A5106M*** |
| 22 | 12.5 × 25 | 14 | 10 | 5.4 | 100 | 170 | B43851F5226M*** |
| 22 | 16 × 25 | 8.4 | 6.3 | 3.4 | 115 | 196 | B43851A5226M*** |
| 33 | 16 × 25 | 7.6 | 5.7 | 3.0 | 125 | 213 | B43851F5336M*** |
| 33 | 16 × 31.5 | 5.6 | 4.2 | 2.2 | 133 | 226 | B43851A5336M*** |
| 47 | 16 × 31.5 | 4.8 | 3.6 | 1.9 | 155 | 264 | B43851F5476M*** |
| 47 | 18 × 31.5 | 4.0 | 3.0 | 1.6 | 185 | 315 | B43851A5476M*** |
| 68 | 18 × 35 | 2.7 | 2.1 | 1.1 | 193 | 328 | B43851A5686M*** |
| 100 | 20 × 40 | 1.8 | 1.4 | 0.74 | 207 | 352 | B43851A5107M*** |

Composition of ordering code

*** = Version

000 = for standard leads, bulk

001 = for kinked leads, bulk (for $\varnothing \geq 10$ mm)

002 = for cut leads, bulk (for $\varnothing \geq 10$ mm)

003 = for crimped leads, blister (for $\varnothing \geq 16$ mm)

004 = for J leads, blister (from $d \times l = 10 \times 12.5$ mm to 18×35 mm)

008 = for taped leads, Ammo pack, lead spacing $F = 5.0$ mm (from $d \times l = 6.3 \times 11$ mm to 12.5×25 mm)

009 = for taped leads, Ammo pack, lead spacing $F = 7.5$ mm (from $d \times l = 16 \times 20$ mm to 18×31.5 mm)

012 = for bent 90° leads, blister (for $\varnothing 16$ and 18 mm)



Useful life

depending on ambient temperature T_A under ripple current operating conditions¹⁾

$V_R = 6.3 \dots 100 \text{ V DC}$

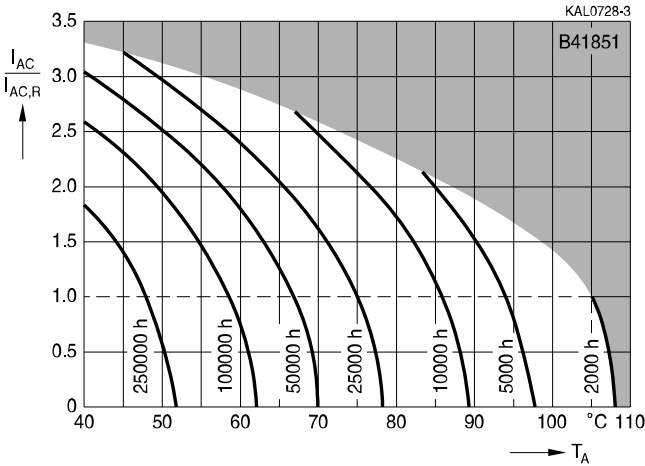

$V_R = 160 \dots 450 \text{ V DC}$

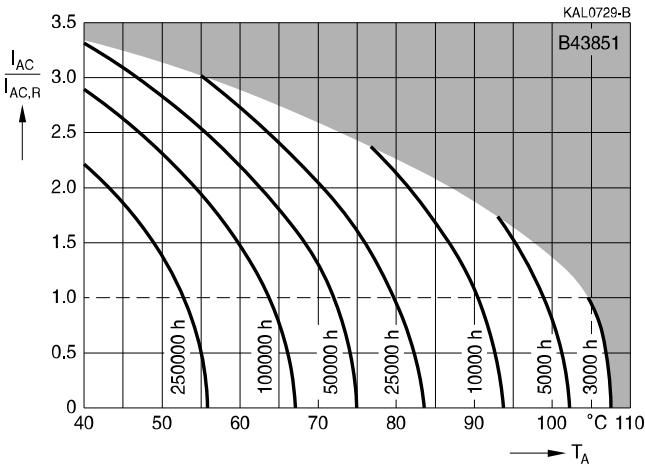

1) Refer to chapter "General technical information, 5.3 Calculation of useful life" for an explanation on how to interpret the useful life

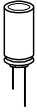

B41851, B43851

Standard series – 105 °C

Frequency factor of permissible ripple current I_{AC} versus frequency f

$V_R \leq 100$ V DC

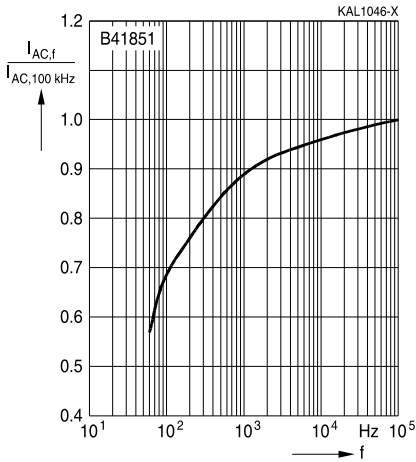

Frequency factor of permissible ripple current I_{AC} versus frequency f

$V_R \geq 160$ V DC

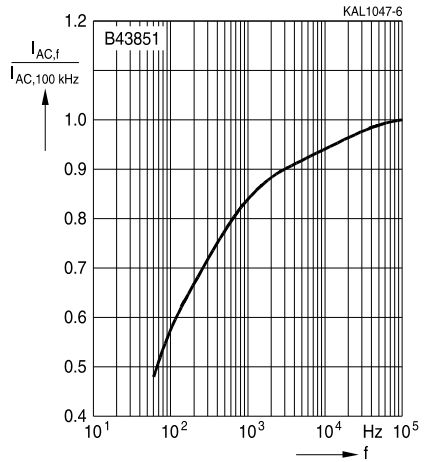



Taping, packing and lead configurations

Taping

Single-ended capacitors are available taped in Ammo pack from diameter 5 to 18 mm as follows:

Lead spacing $F = 2.5$ mm ($\varnothing d = 5 \dots 6.3$ mm)

Lead spacing $F = 3.5$ mm ($\varnothing d = 8$ mm)

Lead spacing $F = 5.0$ mm ($\varnothing d = 5 \dots 12.5$ mm)

Lead spacing $F = 7.5$ mm ($\varnothing d = 16 \dots 18$ mm).

Lead spacing 2.5 mm ($\varnothing d = 5 \dots 6.3$ mm)

Last 3 digits of ordering code: 007

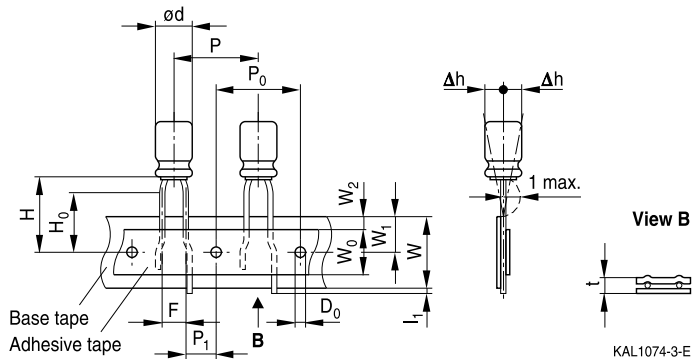

Dimensions in mm

| $\varnothing d$ | F | H | W | W_0 | W_1 | W_2 | H_0 | P | P_0 | P_1 | l_1 | t | Δh | D_0 |
|-----------------|--------------|------------|-----------|-------|-----------|-------|-----------|-----------|-----------|-----------|-------|-----------|------------|-----------|
| 5 | 2.5 | 18.5 | 18.0 | 5.5 | 9.0 | 1.5 | 16.0 | 12.7 | 12.7 | 5.1 | 1.0 | 0.7 | 1.0 | 4.0 |
| 6.3 | | | | | | | | | | | | | | |
| Tolerance | +0.8 -0.2 | ± 0.75 | ± 0.5 | min. | ± 0.5 | max. | ± 0.5 | ± 1.0 | ± 0.2 | ± 0.5 | max. | ± 0.2 | max. | ± 0.2 |

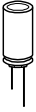

B41851, B43851

Standard series – 105 °C

Lead spacing 3.5 mm ($\varnothing d = 8$ mm)

Last 3 digits of ordering code: 006

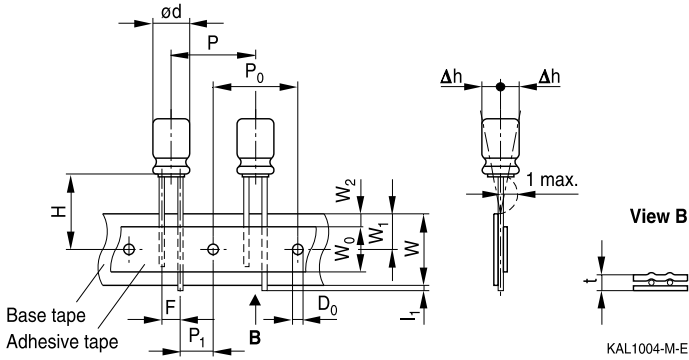

Dimensions in mm

| $\varnothing d$ | F | H | W | W_0 | W_1 | W_2 | P | P_0 | P_1 | L_1 | t | Δh | D_0 |
|-----------------|--------------|------|-----------|-------|-----------|-------|-----------|-----------|-----------|-------|-----------|------------|-----------|
| 8 | 3.5 | 18.5 | 18.0 | 12.5 | 9.0 | 1.5 | 12.7 | 12.7 | 4.6 | 1.0 | 0.7 | 1.0 | 4.0 |
| Tolerance | +0.8 -0.2 | 1.0 | ± 0.5 | min. | ± 0.5 | max. | ± 1.0 | ± 0.2 | ± 0.5 | max. | ± 0.2 | max. | ± 0.2 |

Lead spacing 5.0 mm ($\varnothing d = 5 \dots 8$ mm)

Last 3 digits of ordering code: 008

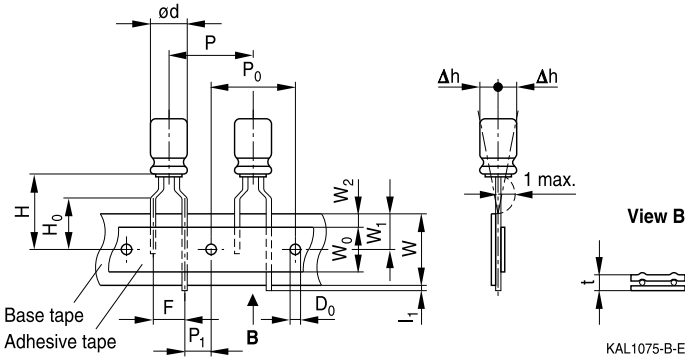
Lead spacing 5.0 mm ($\varnothing d = 10 \dots 12.5$ mm)

Last 3 digits of ordering code: 008

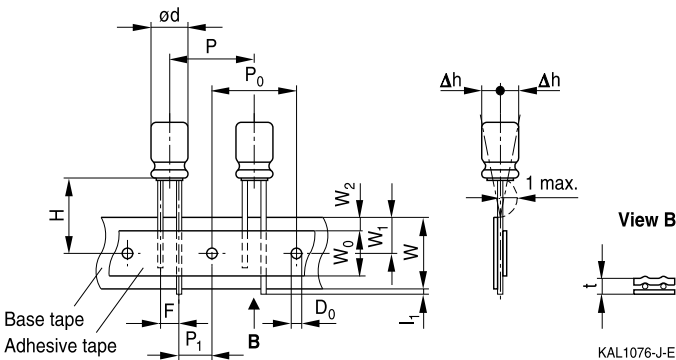
Dimensions in mm

| $\varnothing d$ | F | H | W | W_0 | W_1 | W_2 | H_0 | P | P_0 | P_1 | l_1 | t | Δh | D_0 |
|-----------------|--------------|------------|-----------|-------|-----------|-------|-----------|-----------|-----------|-----------|-------|-----------|------------|-----------|
| 5 | 5.0 | 18.5 | 18.0 | 5.5 | 9.0 | 1.5 | 16.0 | 12.7 | 12.7 | 3.85 | 1.0 | 0.7 | 1.0 | 4.0 |
| 6.3 | | 20.0 | | | | | 16.0 | 12.7 | 12.7 | 3.85 | | | | |
| 8 | 5.0 | 19.0 | 18.0 | 12.5 | 9.0 | 1.5 | — | 12.7 | 12.7 | 3.85 | 1.0 | 0.7 | 1.0 | 4.0 |
| 10 | | 19.0 | | | | | — | 15.0 | 15.0 | 5.0 | | | | |
| 12.5 | | — | | | | | — | — | — | — | | | | |
| Tolerance | +0.8 -0.2 | ± 0.75 | ± 0.5 | min. | ± 0.5 | max. | ± 0.5 | ± 1.0 | ± 0.2 | ± 0.5 | max. | ± 0.2 | max. | ± 0.2 |



B41851, B43851

Standard series – 105 °C

Lead spacing 7.5 mm (∅ d = 16 ...18 mm)

Last 3 digits of ordering code: 009

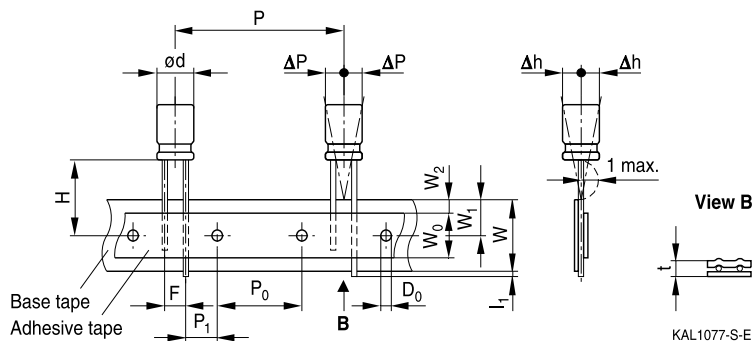

Dimensions in mm

| ∅ d | F | H | W | W ₀ | W ₁ | W ₂ | P | P ₀ | P ₁ | l ₁ | t | ΔP | Δh | D ₀ |
|-----------|------|---------------|------|----------------|----------------|----------------|------|----------------|----------------|----------------|------|------|------|----------------|
| 16 | 7.5 | 18.5 | 18.0 | 12.5 | 9.0 | 1.5 | 30.0 | 15.0 | 3.75 | 1.0 | 0.7 | 0 | 0 | 4.0 |
| 18 *) | | | | | | | | | | | | | | |
| Tolerance | ±0.8 | -0.5 +0.75 | ±0.5 | min. | ±0.5 | max. | ±1.0 | ±0.2 | ±0.5 | max. | ±0.2 | ±1.0 | ±1.0 | ±0.2 |

*) Available only for case dimensions 18 × 20, 18 × 25 and 18 × 31.5 mm

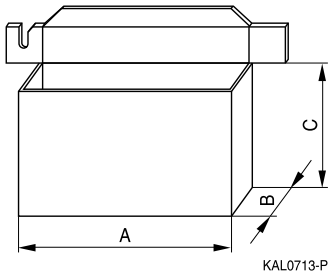
Packing units and box dimensions
Ammo pack

| Case size $d \times l$ mm | Dimensions (mm) | | | Packing units pcs. |
|---------------------------------|-----------------|-----------|-----------|--------------------------|
| | A_{max} | B_{max} | C_{max} | |
| 5 × 11 | 345 | 55 | 240 | 2000 |
| 6.3 × 11 | 345 | 55 | 290 | 2000 |
| 8 × 11.5 | 345 | 55 | 240 | 1000 |
| 10 × 12.5 | 345 | 55 | 280 | 750 |
| 10 × 16 | 345 | 60 | 200 | 500 |
| 10 × 20 | 345 | 60 | 200 | 500 |
| 12.5 × 20 | 345 | 65 | 280 | 500 |
| 12.5 × 25 | 345 | 65 | 280 | 500 |
| 12.5 × 25 | 345 | 65 | 280 | 500 |
| 12.5 × 30 | 345 | 65 | 275 | 500 |
| 16 × 20 | 315 | 65 | 275 | 300 |
| 16 × 25 | 315 | 65 | 275 | 300 |
| 16 × 31.5 | 315 | 65 | 275 | 300 |
| 18 × 20 | 315 | 65 | 275 | 250 |
| 18 × 25 | 315 | 65 | 275 | 250 |
| 18 × 31.5 | 315 | 65 | 275 | 250 |



B41851, B43851

Standard series – 105 °C

Kinked or cut leads

Single-ended capacitors are available with kinked or cut leads. Other lead configurations also available upon request.

Kinked leads

Last 3 digits of ordering code: 001

With stand-off rubber seal

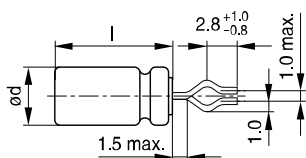

KAL1081-K

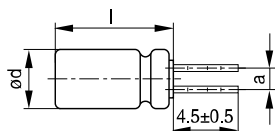

KAL1083-2

With flat rubber seal

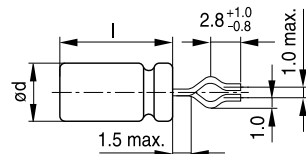

KAL1082-T

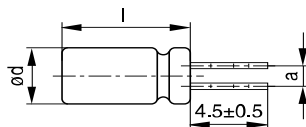

KAL1084-A

| Case size d × l (mm) | Dimensions (mm) a ±0.5 |
|-------------------------|---------------------------|
| 10 × 20 | 5.0 |
| 12.5 × 20 | 5.0 |
| 12.5 × 25 | 5.0 |
| 12.5 × 30 | 5.0 |
| 12.5 × 35 | 5.0 |
| 12.5 × 40 | 5.0 |
| 16 × 20 | 7.5 |
| 16 × 25 | 7.5 |
| 16 × 31.5 | 7.5 |
| 18 × 20 | 7.5 |
| 18 × 25 | 7.5 |
| 18 × 31.5 | 7.5 |
| 18 × 35 | 7.5 |
| 18 × 40 | 7.5 |
| 20 × 20 | 10.0 |
| 20 × 25 | 10.0 |
| 20 × 40 | 10.0 |
| 22 × 30 | 10.0 |
| 22 × 35 | 10.0 |
| 22 × 40 | 10.0 |

Cut leads

Last 3 digits of ordering code: 002

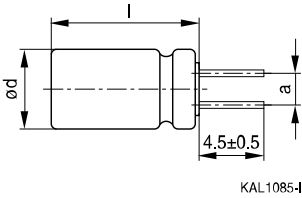
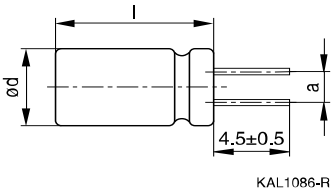
With stand-off rubber seal

With flat rubber seal

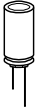
| Case size d × l (mm) | Dimensions (mm) a ±0.5 |
|-------------------------|---------------------------|
| 10 × 12.5 | 5.0 |
| 10 × 16 | 5.0 |
| 10 × 20 | 5.0 |
| 12.5 × 20 | 5.0 |
| 12.5 × 25 | 5.0 |
| 12.5 × 30 | 5.0 |
| 12.5 × 35 | 5.0 |
| 12.5 × 40 | 5.0 |
| 16 × 20 | 7.5 |
| 16 × 25 | 7.5 |
| 16 × 31.5 | 7.5 |
| 18 × 20 | 7.5 |
| 18 × 25 | 7.5 |
| 18 × 31.5 | 7.5 |
| 18 × 35 | 7.5 |
| 18 × 40 | 7.5 |
| 20 × 20 | 10.0 |
| 20 × 25 | 10.0 |
| 20 × 40 | 10.0 |



B41851, B43851

Standard series – 105 °C

PAPR leads (Protection Against Polarity Reversal)

These lead configurations ensure correct placement of the capacitor on the PCB with regard to polarity. PAPR leads are available for diameters from 10 mm up to 20 mm.

There are three configurations available: Crimped leads, J leads, bent 90° leads

Crimped leads

Last 3 digits of ordering code: 003

With stand-off rubber seal

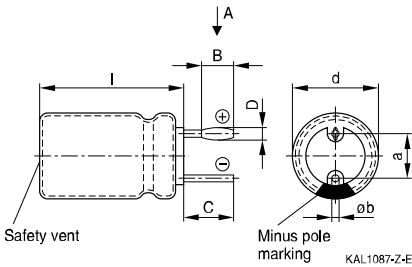

With flat rubber seal

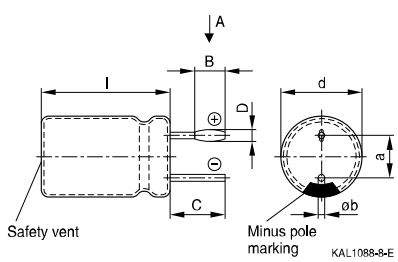

Suggestion for PCB hole diameter

View A

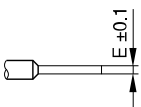

Suggestion for PCB hole diameter, wire ø0.8 mm

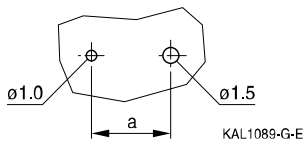

Suggestion for PCB hole diameter, wire ø1.0 mm

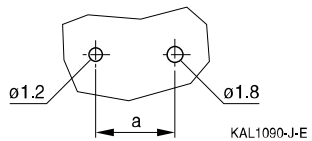

| Case size d × l (mm) | Dimensions (mm) | | | | | |
|-------------------------|-----------------|--------|--------|--------|--------|-----------|
| | B ±0.2 | C ±0.5 | D ±0.1 | E ±0.1 | a ±0.5 | Øb |
| 16 × 20 | 1.5 | 3.0 | 1.3 | 0.3 | 7.5 | 0.8 ±0.05 |
| 16 × 25 | 1.5 | 3.0 | 1.3 | 0.3 | 7.5 | 0.8 ±0.05 |
| 16 × 31.5 | 1.5 | 3.0 | 1.3 | 0.3 | 7.5 | 0.8 ±0.05 |
| 18 × 20 | 1.5 | 3.0 | 1.3 | 0.3 | 7.5 | 0.8 ±0.1 |
| 18 × 25 | 1.5 | 3.0 | 1.3 | 0.3 | 7.5 | 0.8 ±0.1 |
| 18 × 31.5 | 1.5 | 3.0 | 1.3 | 0.3 | 7.5 | 0.8 ±0.1 |
| 18 × 35 | 1.5 | 3.0 | 1.3 | 0.3 | 7.5 | 0.8 ±0.1 |
| 18 × 40 | 1.5 | 3.0 | 1.3 | 0.3 | 7.5 | 0.8 ±0.1 |
| 20 × 20 | 1.5 | 3.0 | 1.6 | 0.3 | 10.0 | 1.0 ±0.1 |
| 20 × 25 | 1.5 | 3.0 | 1.6 | 0.3 | 10.0 | 1.0 ±0.1 |
| 20 × 40 | 1.5 | 3.0 | 1.6 | 0.3 | 10.0 | 1.0 ±0.1 |

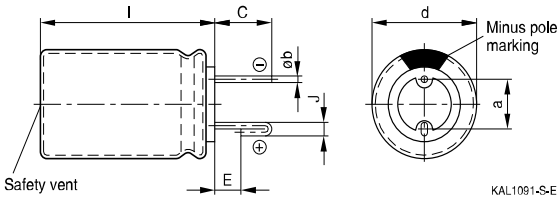

J leads

Last 3 digits of ordering code: 004

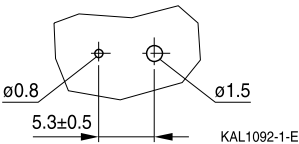

KAL1091-S-E

Suggestion for PCB hole diameter

 Suggestion for PCB hole diameter,
wire $\varnothing 0.6$ mm

KAL1092-1-E

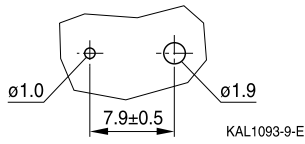
 Suggestion for PCB hole diameter,
wire $\varnothing 0.8$ mm

KAL1093-9-E

| Case size $d \times l$ (mm) | Dimensions (mm) | | | | |
|--------------------------------|-----------------|-------------|-------------|-------------|-----------------|
| | $C \pm 0.5$ | $E \pm 0.5$ | $J \pm 0.2$ | $a \pm 0.5$ | $\varnothing b$ |
| 10 × 12.5 | 3.2 | 0.7 | 1.2 | 5.0 | 0.6 ± 0.05 |
| 10 × 16 | 3.2 | 0.7 | 1.2 | 5.0 | 0.6 ± 0.05 |
| 10 × 20 | 3.2 | 0.7 | 1.2 | 5.0 | 0.6 ± 0.05 |
| 12.5 × 20 | 3.2 | 0.7 | 1.2 | 5.0 | 0.6 ± 0.05 |
| 12.5 × 25 | 3.2 | 0.7 | 1.2 | 5.0 | 0.6 ± 0.05 |
| 16 × 20 | 3.5 | 0.7 | 1.6 | 7.5 | 0.8 ± 0.05 |
| 16 × 25 | 3.5 | 0.7 | 1.6 | 7.5 | 0.8 ± 0.05 |
| 16 × 31.5 | 3.5 | 0.7 | 1.6 | 7.5 | 0.8 ± 0.05 |
| 18 × 20 | 3.5 | 0.7 | 1.6 | 7.5 | 0.8 ± 0.1 |
| 18 × 25 | 3.5 | 0.7 | 1.6 | 7.5 | 0.8 ± 0.1 |
| 18 × 31.5 | 3.5 | 0.7 | 1.6 | 7.5 | 0.8 ± 0.1 |
| 18 × 35 | 3.5 | 0.7 | 1.6 | 7.5 | 0.8 ± 0.1 |

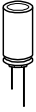

B41851, B43851

Standard series – 105 °C

Bent 90° leads for horizontal mounting pinning

Last 3 digits of ordering code: 012

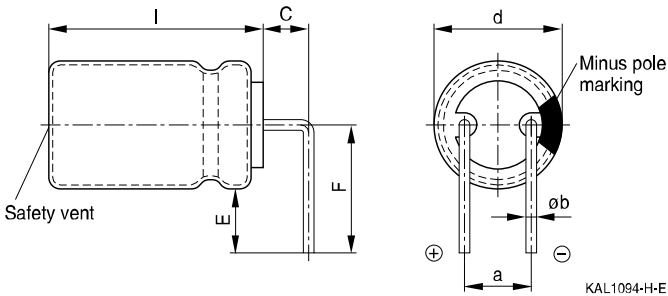

| Case size d × l (mm) | Dimensions (mm) | | | | |
|-------------------------|-----------------|--------|--------|--------|-----------|
| | C ±0.5 | E ±0.5 | F ±0.5 | a ±0.5 | Øb |
| 16 × 20 | 4.0 | 4.0 | 12.0 | 7.5 | 0.8 ±0.05 |
| 16 × 25 | 4.0 | 4.0 | 12.0 | 7.5 | 0.8 ±0.05 |
| 16 × 31.5 | 4.0 | 4.0 | 12.0 | 7.5 | 0.8 ±0.05 |
| 18 × 20 | 4.0 | 4.0 | 13.0 | 7.5 | 0.8 ±0.1 |
| 18 × 25 | 4.0 | 4.0 | 13.0 | 7.5 | 0.8 ±0.1 |
| 18 × 31.5 | 4.0 | 4.0 | 13.0 | 7.5 | 0.8 ±0.1 |
| 18 × 35 | 4.0 | 4.0 | 13.0 | 7.5 | 0.8 ±0.1 |
| 18 × 40 | 4.0 | 4.0 | 13.0 | 7.5 | 0.8 ±0.1 |

Bent leads for diameter 12.5 mm available upon request.



B41851, B43851

Standard series – 105 °C



Overview of packing units and code numbers for case sizes 5 × 11 ... 16 × 31.5

| | | | | | PAPR | | | | |
|---|------------------------|---------------------|--------------------------|-----------------------|------------------|------------|-------------------------------|------------|------------|
| Case size d × l | Stan- dard, bulk | Taped, Ammo pack | Kinked leads, bulk | Cut leads, bulk | Crimped leads | J leads | Bent 90° leads, blister | | |
| mm | pcs. | pcs. | pcs. | pcs. | pcs. | pcs. | pcs. | | |
| 5 × 11 | 2000 | 2000 | – | – | – | – | | | |
| 6.3 × 11 | 2500 | 2000 | – | – | – | – | | | |
| 8 × 11.5 | 1000 | 1000 | – | – | – | – | | | |
| 10 × 12.5 | 1000 | 750 | – | 1000 | – | 675 | | | |
| 10 × 16 | 100 | 500 | – | 1000 | – | 675 | | | |
| 10 × 20 | 500 | 500 | 500 | 500 | – | 500 | | | |
| 12.5 × 20 | 350 | 500 | 350 | 350 | – | 300 | ¹⁾ | | |
| 12.5 × 25 | 250 | 500 | 500 | 500 | – | 225 | ¹⁾ | | |
| 12.5 × 30 | 200 | 500 | 175 | 175 | – | 180 | ¹⁾ | | |
| 12.5 × 35 | 175 | - | 175 | 175 | – | 150 | ¹⁾ | | |
| 12.5 × 40 | 175 | - | 175 | 175 | – | 150 | ¹⁾ | | |
| 16 × 20 | 250 | 300 | 200 | 200 | 200 | 200 | 120 | | |
| 16 × 25 | 250 | 300 | 200 | 200 | 200 | 200 | 120 | | |
| 16 × 31.5 | 200 | 300 | 250 | 250 | 344 | 344 | 120 | | |
| The last three digits of the complete ordering code state the lead configuration | 000 | Code | F (mm) | d (mm) | 001 | 002 | 003 | 004 | 012 |
| | | 006 | 3.5 | 8 | | | | | |
| | | 007 | 2.5 | 5...6.3 | | | | | |
| | | 008 | 5 | 5...12.5 | | | | | |
| | | 009 | 7.5 | 16...18 | | | | | |



B41851, B43851

Standard series – 105 °C

Overview of packing units and code numbers for case sizes 18 × 20 ... 25 × 40

| | | | | | PAPR | | | | |
|---|------------------------|---------------------|--------|--------------------------|-----------------------|------------------|------------|-------------------------------|------------|
| Case size d × l | Stan- dard, bulk | Taped, Ammo pack | | Kinked leads, bulk | Cut leads, bulk | Crimped leads | J leads | Bent 90° leads, blister | |
| mm | pcs. | pcs. | | pcs. | pcs. | pcs. | pcs. | pcs. | |
| 18 × 20 | 175 | 250 | | 175 | 175 | 200 | 200 | 120 | |
| 18 × 25 | 150 | 250 | | 150 | 150 | 200 | 200 | 120 | |
| 18 × 31.5 | 100 | 250 | | 100 | 100 | 150 | 150 | 120 | |
| 18 × 35 | 100 | – | | 100 | 100 | 150 | 150 | 150 | |
| 18 × 40 | 125 | – | | 100 | 100 | 120 | – | 72 | |
| 20 × 20 | 125 | – | | 125 | 125 | 200 | – | – | |
| 20 × 25 | 125 | – | | 125 | 125 | 200 | – | – | |
| 20 × 30 | 100 | – | | 100 | 100 | 120 | – | – | |
| 20 × 35 | 100 | – | | 100 | 100 | 120 | – | – | |
| 20 × 40 | 100 | – | | 100 | 100 | 120 | – | – | |
| 22 × 30 | 80 | – | | 100 | 100 | – | – | – | |
| 22 × 35 | 80 | – | | 100 | 100 | – | – | – | |
| 22 × 40 | 80 | – | | 100 | 100 | – | – | – | |
| 25 × 40 | 40 | – | | 100 | – | – | – | – | |
| The last three digits of the complete ordering code state the lead configuration | 000 | Code | F (mm) | d (mm) | 001 | 002 | 003 | 004 | 012 |
| | | 007 | 2.5 | 4...6.3 | | | | | |
| | | 008 | 5 | 6.3...12.5 | | | | | |
| | | 009 | 7.5 | 16...18 | | | | | |



B41851, B43851

Standard series – 105 °C



Cautions and warnings

Personal safety

The electrolytes used by EPCOS have not only been optimized with a view to the intended application, but also with regard to health and environmental compatibility. They do not contain any solvents that are detrimental to health, e.g. dimethyl formamide (DMF) or dimethyl acetamide (DMAC).

Furthermore, part of the high-voltage electrolytes used by EPCOS are self-extinguishing. They contain flame-retarding substances which will quickly extinguish any flame that may have been ignited.

As far as possible, EPCOS does not use any dangerous chemicals or compounds to produce operating electrolytes. However, in exceptional cases, such materials must be used in order to achieve specific physical and electrical properties because no safe substitute materials are currently known. However, the amount of dangerous materials used in our products has been limited to an absolute minimum. Nevertheless, the following rules should be observed when handling Al electrolytic capacitors:

- Any escaping electrolyte should not come into contact with eyes or skin.
- If electrolyte does come into contact with the skin, wash the affected parts immediately with running water. If the eyes are affected, rinse them for 10 minutes with plenty of water. If symptoms persist, seek medical treatment.
- Avoid breathing in electrolyte vapor or mists. Workplaces and other affected areas should be well ventilated. Clothing that has been contaminated by electrolyte must be changed and rinsed in water.



B41851, B43851

Standard series – 105 °C

Product safety

The table below summarize the safety instructions that must be observed without fail. A detailed description can be found in the relevant sections of chapter "General technical information".

| Topic | Safety information | Reference Chapter "General technical information" |
|--|---|--|
| Polarity | Make sure that polar capacitors are connected with the right polarity. | 1 "Basic construction of aluminum electrolytic capacitors" |
| Reverse voltage | Voltages polarity classes should be prevented by connecting a diode. | 3.1.6 "Reverse voltage" |
| Upper category temperature | Do not exceed the upper category temperatur. | 7.2 "Maximum permissible operating temperature" |
| Maintenance | Make periodic inspections of the capacitors. Before the inspection, make sure that the power supply is turned off and carefully discharge the electricity of the capacitors. Do not apply any mechanical stress to the capacitor terminals. | 10 "Maintenance" |
| Mounting position of screw terminal capacitors | Do not mount the capacitor with the terminals (safety vent) upside down. | 11.1. "Mounting positions of capacitors with screw terminals" |
| Mounting of single-ended capacitors | The internal structure of single-ended capacitors might be damaged if excessive force is applied to the lead wires. Avoid any compressive, tensile or flexural stress. Do not move the capacitor after soldering to PC board. Do not pick up the PC board by the soldered capacitor. Do not insert the capacitor on the PC board with a hole space different to the lead space specified. | 11.4 "Mounting considerations for single-ended capacitors" |
| Robustness of terminals | The following maximum tightening torques must not be exceeded when connecting screw terminals: M5: 2 Nm M6: 2.5 Nm | 11.3 "Mounting torques" |
| Soldering | Do not exceed the specified time or temperature | 11.5 "Soldering" |



B41851, B43851

Standard series – 105 °C



| Topic | Safety information | Reference Chapter "General technical information" |
|--|---|---|
| Soldering, cleaning agents | Do not allow halogenated hydrocarbons to come into contact with aluminum electrolytic capacitors. | 11.6 "Cleaning agents" |
| Passive flammability | Avoid external energy, such as fire or electricity. | 8.1 "Passive flammability" |
| Active flammability | Avoid overload of the capacitors. | 8.2 "Active flammability" |
| | | Reference Chapter "Capacitors with screw terminals" |
| Breakdown strength of insulating sleeves | Do not damage the insulating sleeve, especially when ring clips are used for mounting. | "Screw terminals - accessories" |



Important notes

The following applies to all products named in this publication:

1. Some parts of this publication contain **statements about the suitability of our products for certain areas of application**. These statements are based on our knowledge of typical requirements that are often placed on our products in the areas of application concerned. We nevertheless expressly point out **that such statements cannot be regarded as binding statements about the suitability of our products for a particular customer application**. As a rule, EPCOS is either unfamiliar with individual customer applications or less familiar with them than the customers themselves. For these reasons, it is always ultimately incumbent on the customer to check and decide whether an EPCOS product with the properties described in the product specification is suitable for use in a particular customer application.
2. We also point out that **in individual cases, a malfunction of passive electronic components or failure before the end of their usual service life cannot be completely ruled out in the current state of the art, even if they are operated as specified**. In customer applications requiring a very high level of operational safety and especially in customer applications in which the malfunction or failure of a passive electronic component could endanger human life or health (e.g. in accident prevention or life-saving systems), it must therefore be ensured by means of suitable design of the customer application or other action taken by the customer (e.g. installation of protective circuitry or redundancy) that no injury or damage is sustained by third parties in the event of malfunction or failure of a passive electronic component.
3. **The warnings, cautions and product-specific notes must be observed.**
4. In order to satisfy certain technical requirements, **some of the products described in this publication may contain substances subject to restrictions in certain jurisdictions (e.g. because they are classed as "hazardous")**. Useful information on this will be found in our Material Data Sheets on the Internet (www.epcos.com/material). Should you have any more detailed questions, please contact our sales offices.
5. We constantly strive to improve our products. Consequently, **the products described in this publication may change from time to time**. The same is true of the corresponding product specifications. Please check therefore to what extent product descriptions and specifications contained in this publication are still applicable before or when you place an order. We also **reserve the right to discontinue production and delivery of products**. Consequently, we cannot guarantee that all products named in this publication will always be available.
6. Unless otherwise agreed in individual contracts, **all orders are subject to the current version of the "General Terms of Delivery for Products and Services in the Electrical Industry" published by the German Electrical and Electronics Industry Association (ZVEI)**.
7. The trade names EPCOS, EPCOS-JONES, BAOKE, Alu-X, CeraDiode, CSSP, MLSC, PhaseCap, PhaseMod, SIFERRIT, SIFI, SIKOREL, SilverCap, SIMID, SIOV, SIP5D, SIP5K, UltraCap, WindCap are **trademarks registered or pending in Europe and in other countries**. Further information will be found on the Internet at www.epcos.com/trademarks.