

## 250-mA LOW-DROPOUT REGULATOR WITH AUXILIARY POWER MANAGEMENT

SLVS320 – OCTOBER 2000

- Automatic Input Voltage Source Selection
- Glitch-Free Regulated Output
- 5-V Input Voltage Source Detector With Hysteresis
- 250-mA Load Current Capability With 5-V or 3.3-V Input Source
- Low  $r_{DS(on)}$  Auxiliary Switch

### description

The TPPM0304 is a low-dropout regulator with auxiliary power management that provides a constant 3.3-V supply at the output capable of driving a 250-mA load.

The TPPM0304 provides a regulated power output for systems that have multiple input sources and require a constant voltage source with a low-dropout voltage. This is a single output, multiple input, intelligent power source selection device with a low-dropout regulator for either 5VCC or 5VAUX inputs, and a low-resistance bypass switch for the 3.3VAUX input.

Transitions may occur from one input supply to another without generating a glitch, outside of the specification range, on the 3.3-V output. The device has an incorporated reverse blocking scheme to prevent excess leakage from the input terminals in the event that the output voltage is greater than the input voltage.

The input voltage is prioritized in the following order: 5VCC, 5VAUX, and 3.3VAUX.

D PACKAGE†  
(TOP VIEW)

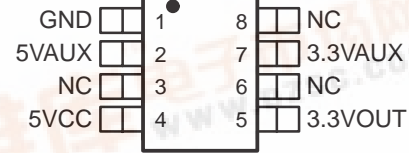

NC – No internal connection

† This package is available taped and reeled. To order this packaging option, add an R suffix to the part number (e.g., TPPM0304DR).

Please be aware that an important notice concerning availability, standard warranty, and use in critical applications of Texas Instruments semiconductor products and disclaimers thereto appears at the end of this data sheet.

**TPPM0304**  
**250-mA LOW-DROPOUT REGULATOR**  
**WITH AUXILIARY POWER MANAGEMENT**  
 SLVS320 – OCTOBER 2000

**functional block diagram**

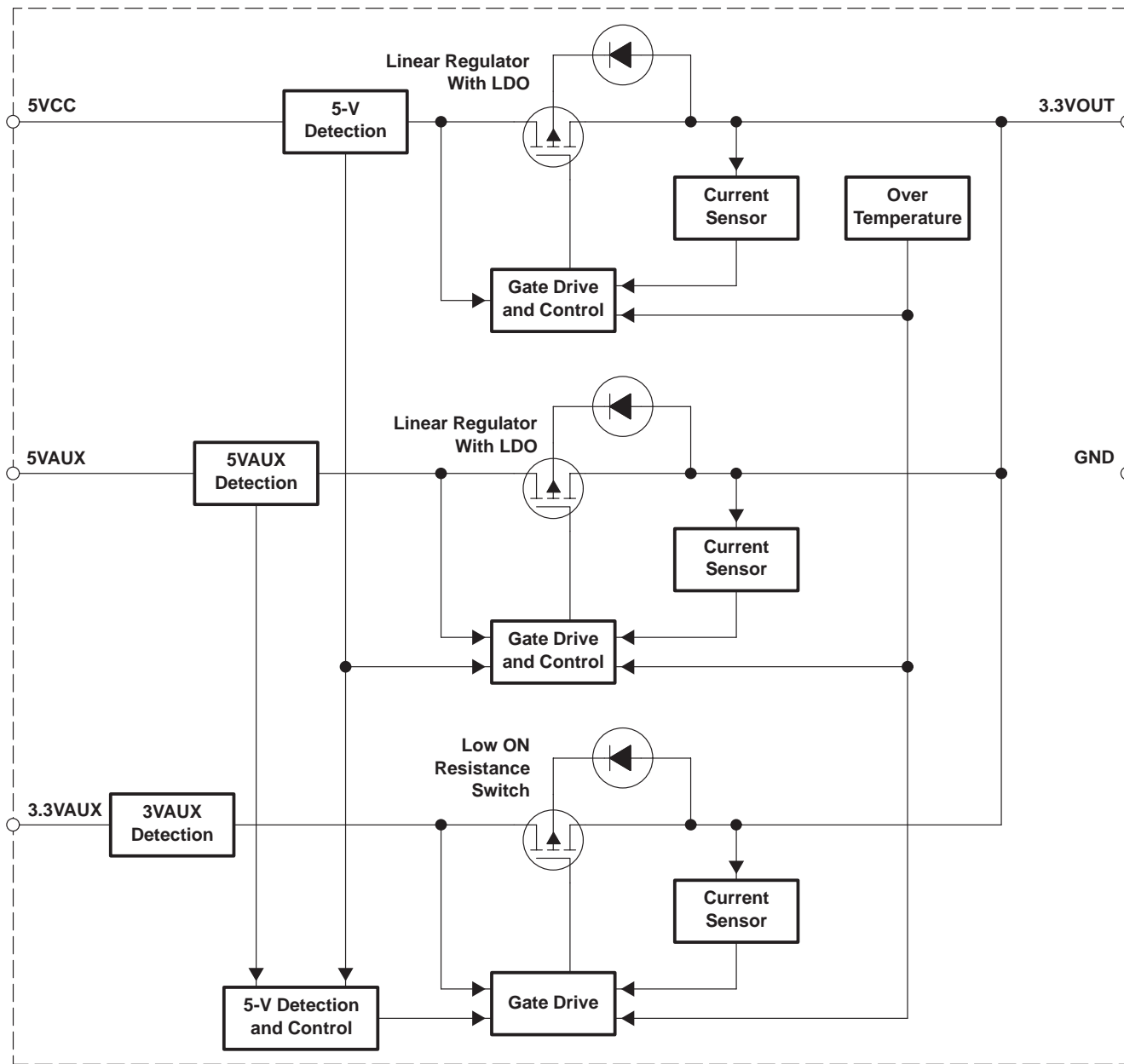

**Terminal Functions**

TERMINAL NAME	NO.	I/O	DESCRIPTION
3.3VAUX	7	I	3.3-V auxiliary input
3.3VOUT	5	O	3.3-V output with a typical capacitance load of 4.7 $\mu$ F
5VAUX	2	I	5-V auxiliary input
5VCC	4	I	5-V main input
GND	1	I	Ground
NC	3, 6, 8	I/O	No internal connection

**Table 1. Input Selection**

INPUT VOLTAGE STATUS (V)			INPUT SELECTED	OUTPUT (V)	OUTPUT (I)
5VCC	5VAUX	3.3VAUX	5VCC/5VAUX/3.3VAUX	3.3VOUT	I <sub>L</sub> (mA)
0	0	0	None	0	0
0	0	3.3	3.3VAUX	3.3	250
0	5	0	5VAUX	3.3	250
0	5	3.3	5VAUX	3.3	250
5	0	0	5VCC	3.3	250
5	0	3.3	5VCC	3.3	250
5	5	0	5VCC	3.3	250
5	5	3.3	5VCC	3.3	250

**absolute maximum ratings over operating free-air temperature (unless otherwise noted)†**

Supply voltage, 5-V main input, V <sub>(5VCC)</sub> (see Notes 1 and 2)	7 V
Auxiliary voltage, 5-V input, V <sub>(5VAUX)</sub> (see Notes 1 and 2)	7 V
Auxiliary voltage, 3.3-V input, V <sub>(3.3VAUX)</sub> (see Notes 1 and 2)	5 V
3.3-V output current limit, I <sub>(LIMIT)</sub>	1.5 A
Continuous power dissipation (low-K), P <sub>D</sub> (see Note 3)	0.625 W
Electrostatic discharge susceptibility, human body model, V <sub>(HBMESD)</sub>	2 kV
Operating ambient temperature range, T <sub>A</sub>	0°C to 70°C
Storage temperature range, T <sub>stg</sub>	-55°C to 150°C
Operating junction temperature range, T <sub>J</sub>	-5°C to 120°C
Lead temperature (soldering, 10 second), T <sub>(LEAD)</sub>	260°C

† Stresses beyond those listed under “absolute maximum ratings” may cause permanent damage to the device. These are stress ratings only, and functional operation of the device at these or any other conditions beyond those indicated under “recommended operating conditions” is not implied. Exposure to absolute-maximum-rated conditions for extended periods may affect device reliability.

- NOTES: 1. All voltage values are with respect to GND.  
 2. Absolute negative voltage on these terminal should not be below -0.5 V.  
 3. The device derates with increase in ambient temperature, T<sub>A</sub>. See Thermal Information section.

**recommended operating conditions**

	MIN	TYP	MAX	UNIT
5-V main input, V <sub>(5VCC)</sub>	4.5		5.5	V
5-V auxiliary input, V <sub>(5VAUX)</sub>	4.5		5.5	V
3.3-V auxiliary input, V <sub>(3.3VAUX)</sub>	3		3.6	V
Load capacitance, C <sub>L</sub>	4.23	4.7	5.17	μF
Load current, I <sub>L</sub>	0		250	mA
Ambient temperature, T <sub>A</sub>	0		70	°C

**TPPM0304**  
**250-mA LOW-DROPOUT REGULATOR**  
**WITH AUXILIARY POWER MANAGEMENT**

SLVS320 – OCTOBER 2000

electrical characteristics over recommended operating free-air temperature range,  $T_A = 0^\circ\text{C}$  to  $70^\circ\text{C}$ ,  $C_L = 4.7\ \mu\text{F}$  (unless otherwise noted)

PARAMETER		TEST CONDITIONS	MIN	TYP	MAX	UNIT
$V_{(5VCC)}/V_{(5VAUX)}$	5-V inputs		4.5	5	5.5	V
$I_{(Q)}$	Quiescent supply current	From 5VCC or 5VAUX terminals, $I_L = 0$ to 250 mA		2.5	5	mA
		From 3.3VAUX terminal, $I_L = 0$ A		250	500	$\mu\text{A}$
$I_L$	Output load current		0.25			A
$I_{(LIMIT)}$	Output current limit	3.3VOUT = 0 V			2	
$T_{(TSD)}^\dagger$	Thermal shutdown	3.3VOUT output shorted to 0 V	150		180	$^\circ\text{C}$
$T_{hys}^\dagger$	Thermal hysteresis			15		
$V_{(3.3VOUT)}$	3.3-V output	$I_L = 250$ mA	3.135	3.3	3.465	V
$C_L$	Load capacitance	Minimal ESR to insure stability of regulated output		4.7		$\mu\text{F}$
$I_{lkg(REV)}$	Reverse leakage output current	Tested for input that is grounded. 3.3VAUX, 5VAUX or 5VCC = GND, 3.3VOUT = 3.3 V			50	$\mu\text{A}$

$^\dagger$  Design targets only. Not tested in production.

**5-V detect**

PARAMETER		TEST CONDITIONS	MIN	TYP	MAX	UNIT
$V_{(TO\_LO)}$	Threshold voltage, low	5VAUX or 5VCC $\downarrow$	3.85	4.05	4.25	V
$V_{(TO\_HI)}$	Threshold voltage, high	5VAUX or 5VCC $\uparrow$	4.1	4.3	4.5	V

**auxiliary switch**

PARAMETER		TEST CONDITIONS	MIN	TYP	MAX	UNIT
$R_{(SWITCH)}$	Auxiliary switch resistance	5VAUX = 5VCC = 0 V, 3.3VAUX = 3.3 V, $I_L = 150$ mA			0.4	$\Omega$
$\Delta V_{O(\Delta V I)}$	Line regulation voltage	5VAUX or 5VCC = 4.5 V to 5.5 V		2		mV
$\Delta V_{O(\Delta I O)}$	Load regulation voltage	20 mA < $I_L$ < 250 mA		40		mV
$V_I - V_O$	Dropout voltage	$I_L < 250$ mA			1	V

**thermal characteristics**

PARAMETER		MIN	TYP	MAX	UNIT
$R_{\theta JC}$	Thermal impedance, junction-to-case			39	$^\circ\text{C}/\text{W}$
$R_{\theta JA}$	Thermal impedance, junction-to-ambient	Low-K (see Note 4)		176	$^\circ\text{C}/\text{W}$
		High-K (see Note 4)		98	

NOTE 4: See JEDEC PCB specifications for low-K and high-K.

TYPICAL CHARACTERISTICS

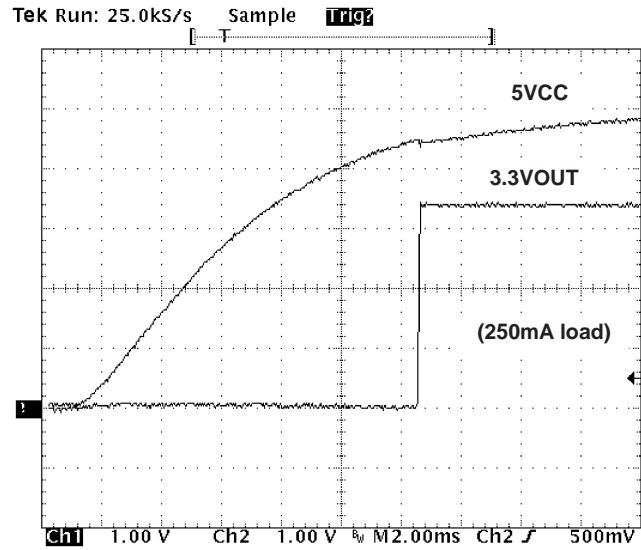

Figure 1. 5VCC Cold Start

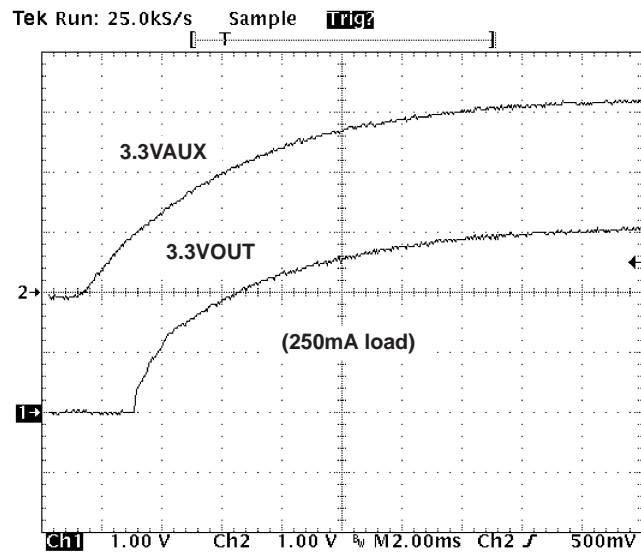

Figure 2. 3.3VAUX Cold Start

TYPICAL CHARACTERISTICS

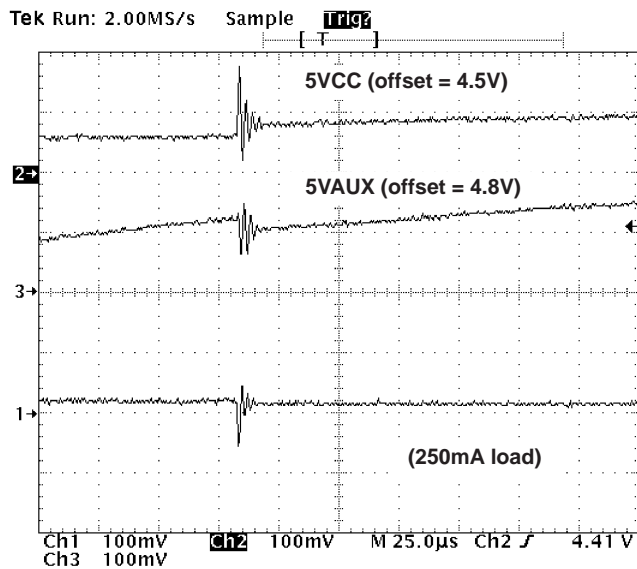

Figure 3. 5VCC Power Up (5VAUX = 5 V)

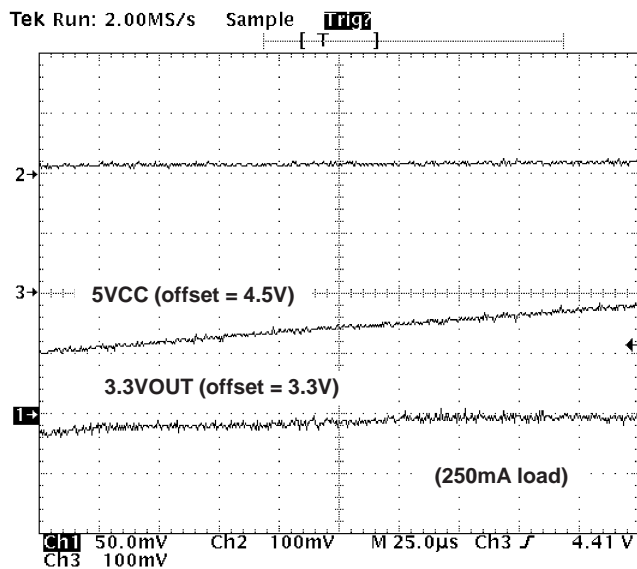
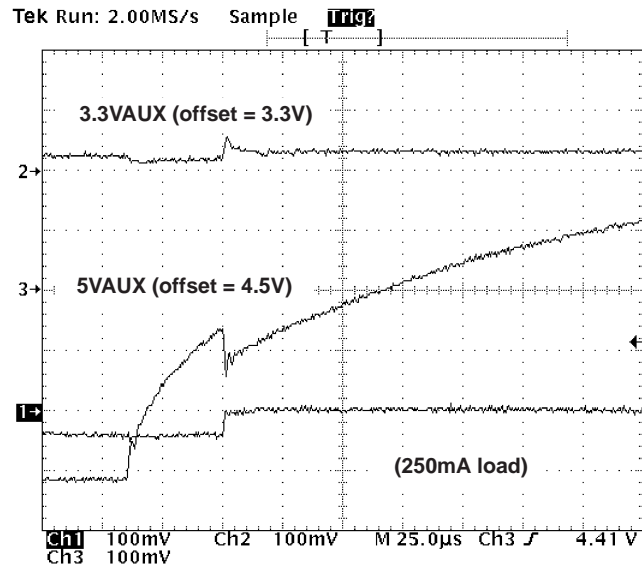
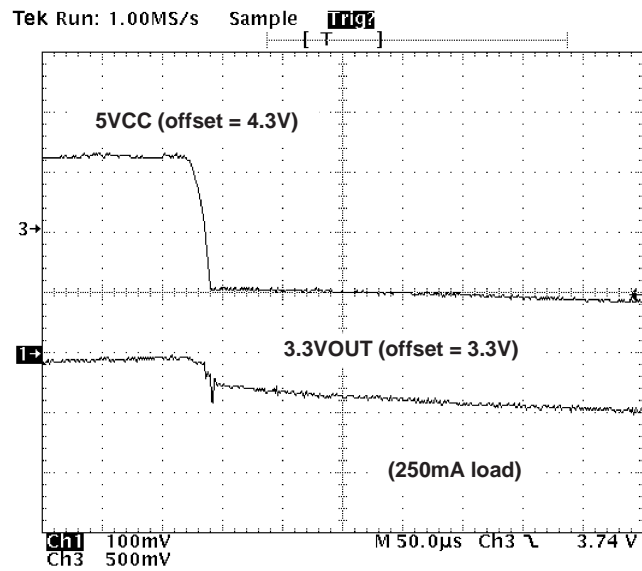

Figure 4. 5VCC Power Up (3.3VAUX = 3.3 V)

**TYPICAL CHARACTERISTICS**



**Figure 5. 5VAUX Power Up (3.3VAUX = 3.3 V)**



**Figure 6. 5VCC Power Down (3.3VAUX = 3.3 V)**

TYPICAL CHARACTERISTICS

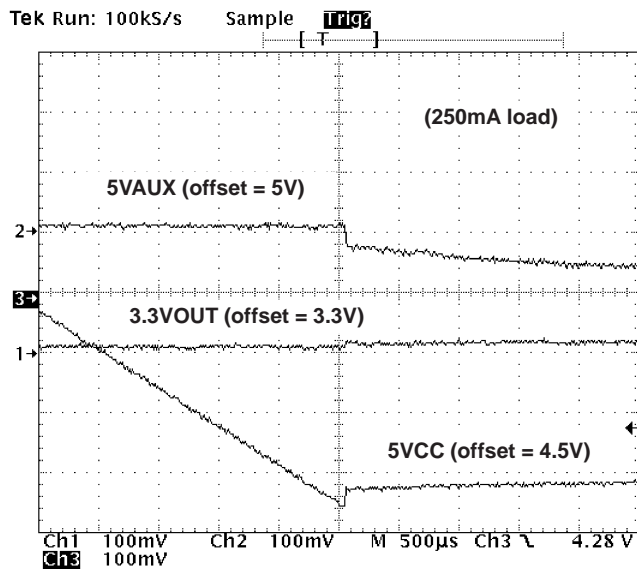

Figure 7. 5VCC Power Down (5VAUX = 5 V)

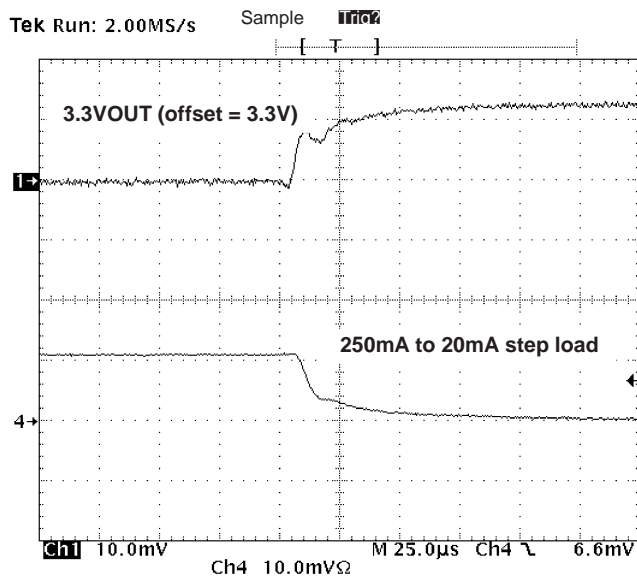

Figure 8. 5VCC Load Transient Response Falling



TYPICAL CHARACTERISTICS

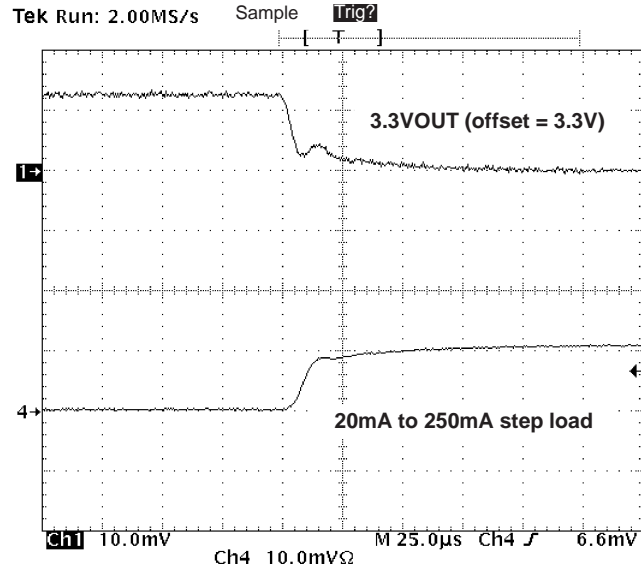

Figure 9. 5VCC Load Transient Response Rising

# TPPM0304

## 250-mA LOW-DROPOUT REGULATOR WITH AUXILIARY POWER MANAGEMENT

SLVS320 – OCTOBER 2000

---

### THERMAL INFORMATION

To ensure reliable operation of the device, the junction temperature of the output device must be within the safe operating area (SOA). This is achieved by having a means to dissipate the heat generated from the junction of the output structure. There are two components that contribute to thermal resistance. They consist of two paths in series. The first is the junction to case thermal resistance,  $R_{\theta JC}$ ; the second is the case to ambient thermal resistance,  $R_{\theta CA}$ . The overall junction to ambient thermal resistance,  $R_{\theta JA}$ , is determined by:

$$R_{\theta JA} = R_{\theta JC} + R_{\theta CA}$$

The ability to efficiently dissipate the heat from the junction is a function of the package style and board layout incorporated in the application. The operating junction temperature is determined by the operating ambient temperature,  $T_A$ , and the junction power dissipation,  $P_J$ .

The junction temperature,  $T_J$ , is equal to the following thermal equation:

$$T_J = T_A + P_J (R_{\theta JC}) + P_J (R_{\theta CA})$$

$$T_J = T_A + P_J (R_{\theta JA})$$

This particular application uses the 8-pin SO package with standard lead frame with a dedicated ground terminal. Hence, the maximum power dissipation allowable for an operating ambient temperature of 70°C, and a maximum junction temperature of 150°C is determined as:

$$P_J = (T_J - T_A)/R_{\theta JA}$$

$$P_J = (150 - 70)/176 = 0.45 \text{ W when using a low-K PCB.}$$

$$P_J = (150 - 70)/98 = 0.81 \text{ W when using a high-K PCB.}$$

Worst case maximum power dissipation is determined by:

$$P_D = (5.5 - 3) \times 0.25 = 0.625 \text{ W}$$

Normal operating maximum power dissipation is (see Figure 1):

$$P_D = (5 - 3.3) \times 0.25 = 0.425 \text{ W}$$

### THERMAL INFORMATION

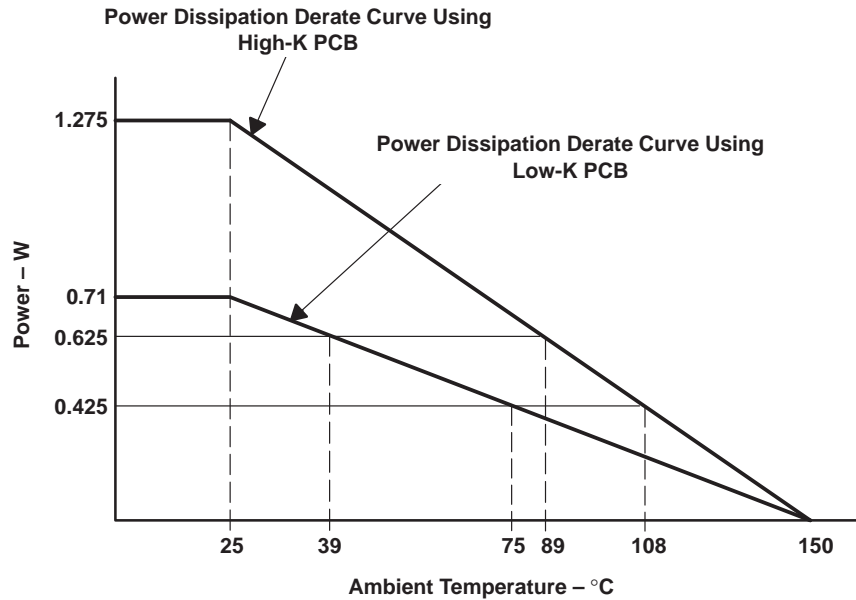

NOTE: These curves are to be used for guideline purposes only. For a particular application, a more specific thermal characterization is required.

**Figure 10. Power Dissipation Derating Curves**

### APPLICATION INFORMATION

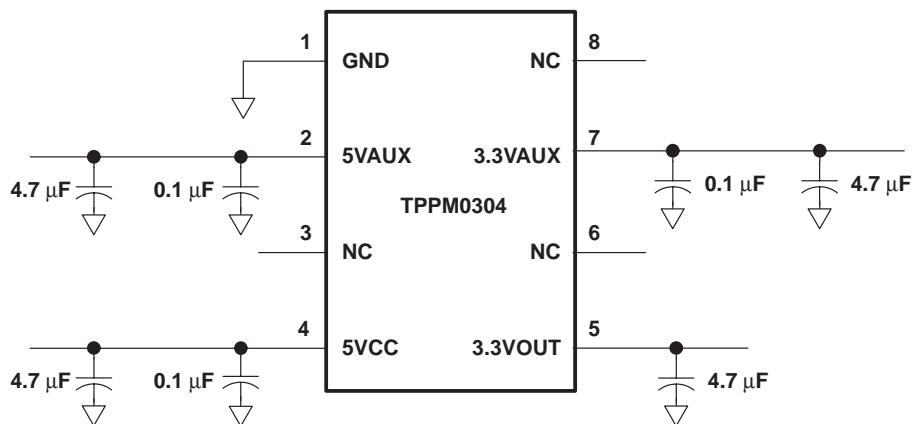

**Figure 11. Typical Application Schematic**

**TPPM0304**  
**250-mA LOW-DROPOUT REGULATOR**  
**WITH AUXILIARY POWER MANAGEMENT**

SLVS320 – OCTOBER 2000

**MECHANICAL DATA**

**D (R-PDSO-G\*\*)**

**PLASTIC SMALL-OUTLINE PACKAGE**

14 PINS SHOWN

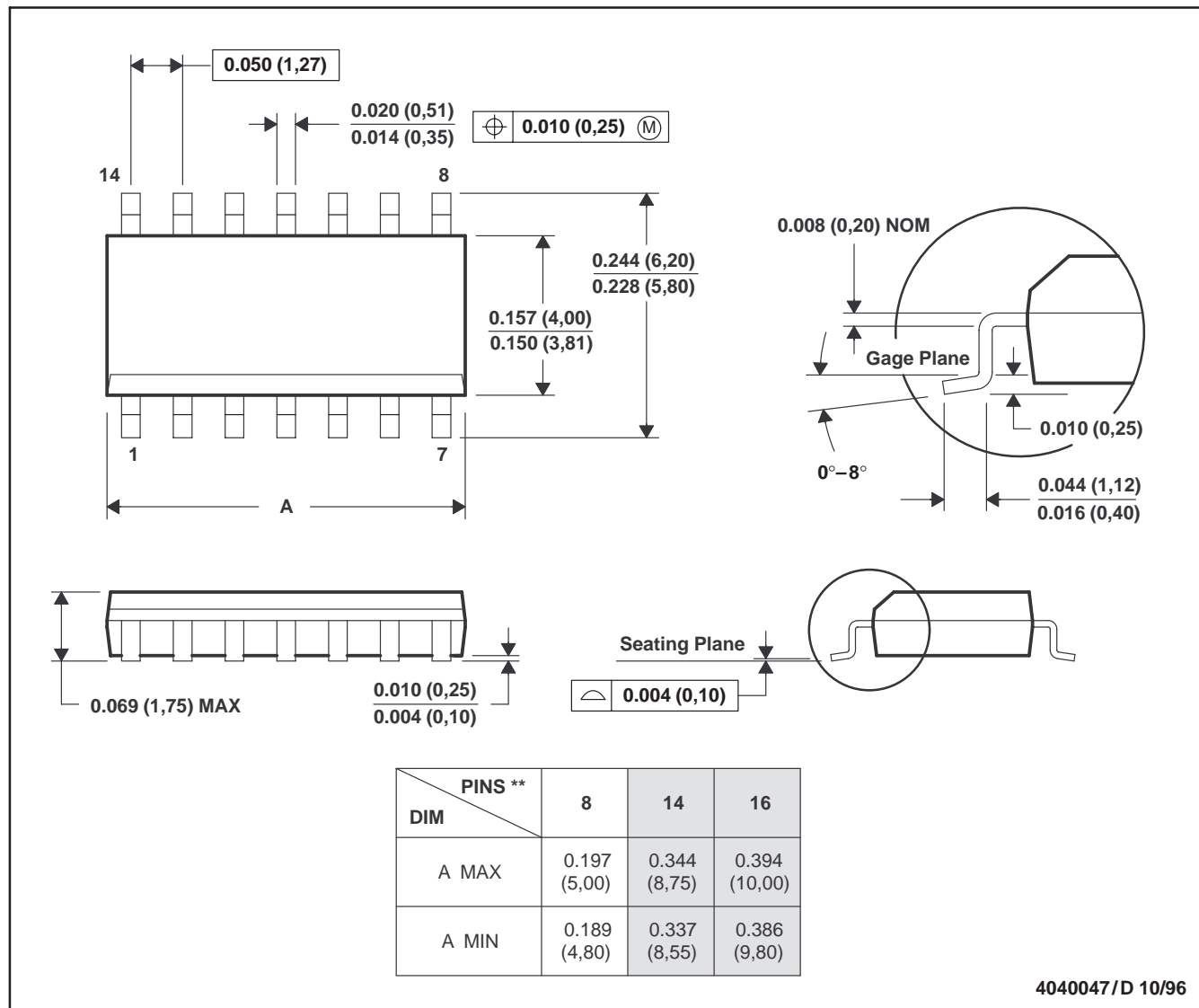

4040047/D 10/96

- NOTES: A. All linear dimensions are in inches (millimeters).  
 B. This drawing is subject to change without notice.  
 C. Body dimensions do not include mold flash or protrusion, not to exceed 0.006 (0,15).  
 D. Falls within JEDEC MS-012

## **IMPORTANT NOTICE**

Texas Instruments and its subsidiaries (TI) reserve the right to make changes to their products or to discontinue any product or service without notice, and advise customers to obtain the latest version of relevant information to verify, before placing orders, that information being relied on is current and complete. All products are sold subject to the terms and conditions of sale supplied at the time of order acknowledgment, including those pertaining to warranty, patent infringement, and limitation of liability.

TI warrants performance of its semiconductor products to the specifications applicable at the time of sale in accordance with TI's standard warranty. Testing and other quality control techniques are utilized to the extent TI deems necessary to support this warranty. Specific testing of all parameters of each device is not necessarily performed, except those mandated by government requirements.

Customers are responsible for their applications using TI components.

In order to minimize risks associated with the customer's applications, adequate design and operating safeguards must be provided by the customer to minimize inherent or procedural hazards.

TI assumes no liability for applications assistance or customer product design. TI does not warrant or represent that any license, either express or implied, is granted under any patent right, copyright, mask work right, or other intellectual property right of TI covering or relating to any combination, machine, or process in which such semiconductor products or services might be or are used. TI's publication of information regarding any third party's products or services does not constitute TI's approval, warranty or endorsement thereof.