

# The RF Line NPN Silicon RF Power Transistor

The TP5051 is designed for 470 MHz cellular radio base stations in both analog and digital applications. It incorporates high value emitter ballast resistors, gold metallizations and offers a high degree of reliability and ruggedness.

- Specified 470 MHz Characteristics
  - Output Power — 50 Watts @ 24 Volts, 60 Watts @ 26 Volts
  - Gain — 9 dB min
  - Efficiency — 60% min
  - Class AB or C Operation
- Circuit board photomaster available upon request by contacting RF Tactical Marketing in Phoenix, AZ.

## TP5051

Motorola Preferred Device

50/60 W, 470 MHz  
RF POWER TRANSISTOR  
NPN SILICON

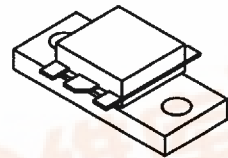

CASE 333A-02, STYLE 2

### MAXIMUM RATINGS

Rating	Symbol	Value	Unit
Collector-Emitter Voltage	$V_{CE}$	40	Vdc
Collector-Base Voltage	$V_{CB}$	48	Vdc
Emitter-Base Voltage	$V_{EB}$	4	Vdc
Collector-Current — Continuous	$I_C$	10	Adc
Total Device Dissipation @ $T_C = 25^\circ\text{C}$ Derate above $25^\circ\text{C}$	$P_D$	145 0.8	Watts $\text{W}/^\circ\text{C}$
Storage Temperature Range	$T_{stg}$	-65 to +150	$^\circ\text{C}$
Operating Junction Temperature	$T_J$	200	$^\circ\text{C}$

### THERMAL CHARACTERISTICS

Characteristic	Symbol	Max	Unit
Thermal Resistance, Junction to Case at $70^\circ\text{C}$ Case (1)	$R_{\theta JC}$	1.2	$^\circ\text{C}/\text{W}$

### ELECTRICAL CHARACTERISTICS ( $T_C = 25^\circ\text{C}$ unless otherwise noted.)

Characteristic	Symbol	Min	Typ	Max	Unit
----------------	--------	-----	-----	-----	------

### OFF CHARACTERISTICS

Collector-Emitter Breakdown Voltage ( $I_C = 60 \text{ mA}$ , $R_{BE} = 75 \Omega$ )	$V_{(BR)CER}$	40	—	—	Vdc
Emitter-Base Breakdown Voltage ( $I_E = 15 \text{ mAdc}$ )	$V_{(BR)EBO}$	4	—	—	Vdc
Collector-Base Breakdown Voltage ( $I_C = 50 \text{ mAdc}$ )	$V_{(BR)CBO}$	48	—	—	Vdc
Collector-Emitter Leakage ( $V_{CE} = 26 \text{ V}$ , $R_{BE} = 75 \Omega$ )	$I_{CER}$	—	—	15	mA

### ON CHARACTERISTICS

DC Current Gain ( $I_C = 1 \text{ Adc}$ , $V_{CE} = 10 \text{ Vdc}$ )	$h_{FE}$	15	—	80	—
--	----------	----	---	----	---

NOTE:

(continued)

1. Thermal resistance is determined under specified RF operating condition.

Preferred devices are Motorola recommended choices for future use and best overall value.

**ELECTRICAL CHARACTERISTICS — continued** ( $T_C = 25^\circ\text{C}$  unless otherwise noted.)

Characteristic	Symbol	Min	Typ	Max	Unit
<b>DYNAMIC CHARACTERISTICS</b>					
Output Capacitance ( $V_{CB} = 26\text{ V}$ , $I_E = 0$ , $f = 1\text{ MHz}$ )	$C_{ob}$	—	60	—	pF
<b>FUNCTIONAL TESTS</b>					
Common-Emitter Amplifier Power Gain ( $V_{CC} = 24\text{ V}$ , $P_{out} = 50\text{ W}$ , $I_{CQ} = 150\text{ mA}$ , $f = 470\text{ MHz}$ )	$G_{p1}$	9	10	—	dB
Collector Efficiency ( $V_{CC} = 24\text{ V}$ , $P_{out} = 50\text{ W}$ , $f = 470\text{ MHz}$ )	$\eta_1$	60	65	—	%
Load Mismatch ( $V_{CC} = 24\text{ V}$ , $P_{out} = 50\text{ W}$ , $I_{CQ} = 150\text{ mA}$ Load VSWR = 5:1, all phase angles at frequency of test)	$\psi_1$	No Degradation in Output Power			
Overdrive ( $V_{CC} = 24\text{ V}$ , $P_{in} = 12\text{ W}$ , $f = 470\text{ MHz}$ )	OD	No Degradation in Output Power			
Power Saturation ( $V_{CC} = 24\text{ V}$ , $f = 470\text{ MHz}$ )	$P_{sat}$	65	—	—	W
Common-Emitter Amplifier Power Gain ( $V_{CC} = 26\text{ V}$ , $P_{out} = 60\text{ W}$ , $I_{CQ} = 150\text{ mA}$ , $f = 470\text{ MHz}$ )	$G_{p2}$	9	10	—	dB
Collector Efficiency ( $V_{CC} = 26\text{ V}$ , $P_{out} = 60\text{ W}$ , $f = 470\text{ MHz}$ )	$\eta_2$	60	65	—	%
Load Mismatch ( $V_{CC} = 26\text{ V}$ , $P_{out} = 60\text{ W}$ , $I_{CQ} = 150\text{ mA}$ Load VSWR = 5:1, all phase angles at frequency of test)	$\psi_2$	No Degradation in Output Power			

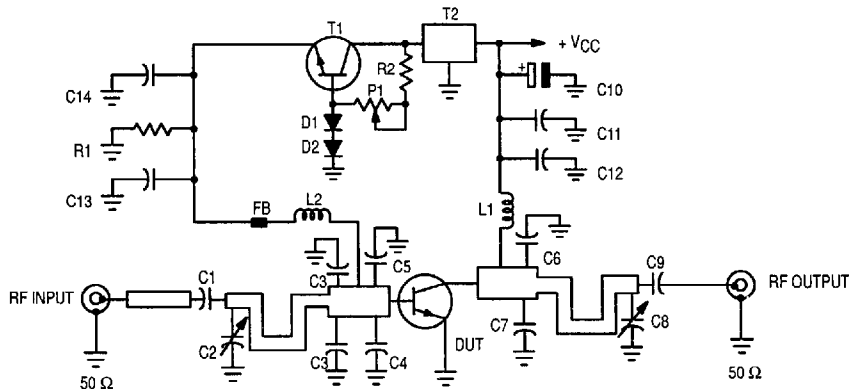

EPOXY GLASS 1/16 INCH  $\epsilon_r = 4.5$

**Components List**

C1, C9,	330 pF, 5%, Chip Capacitor 0805	D1, D2	Diode, 1N4148
C2, C8	AIRTRONIC Trimmer Capacitor 5400	FB	Ferrite Board
C3	10 pF, ATC Chip Capacitor	L1, L2	6 Turns, #18 AWG $\phi$ 4 mm Choke
C3'	12 pF, ATC Chip Capacitor	P1	1 k $\Omega$ , Trimmer
C4, C5	22 pF, ATC Chip Capacitor	R1	56 $\Omega$ , 5%, Chip Resistor 1205
C6	15 pF, ATC Chip Capacitor	R2	470 $\Omega$ , 5%, Chip Resistor 0805
C7	18 pF, ATC Chip Capacitor	T1	SMD Transistor, MJD31C or Similar
C10	47 $\mu$ F, 63 V, Electrolytic Capacitor	T2	Voltage Regulator 7805
C11, C14	15 nF, Chip Capacitor 0805		
C12, C13	330 pF, 5%, Chip Capacitor 0805		

**Figure 1. 470 MHz Electrical Schematic**

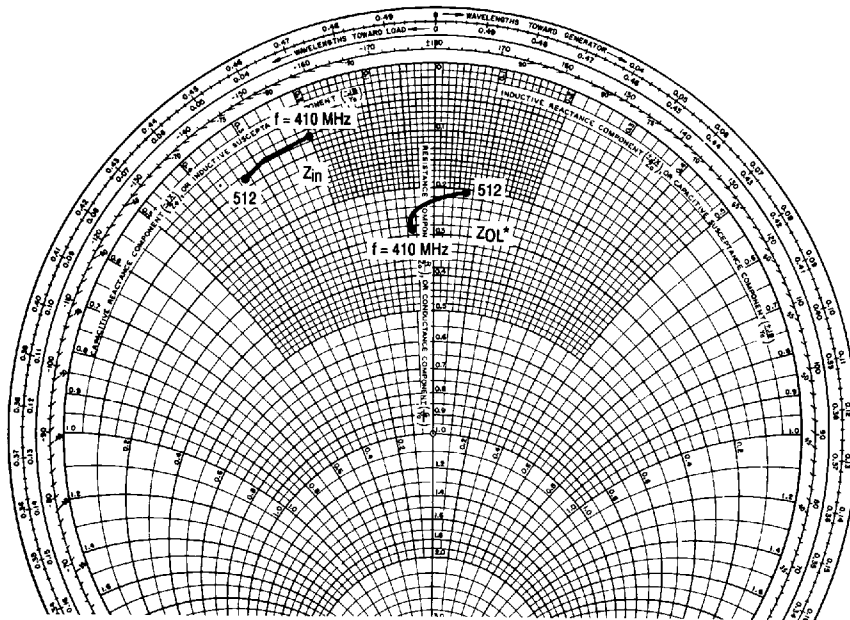

$P_{out} = 50 \text{ W}$ ,  $V_{CE} = 24 \text{ V}$

f (MHz)	$Z_{in}$ ( $\Omega$ )	$Z_{OL}^*$ ( $\Omega$ )
512	$1 - j3.2$	$2 - j0.7$
490	$0.97 - j2.8$	$2.2 - j0.5$
470	$0.9 - j2.7$	$2.4 + j0.13$
450	$0.85 - j2.5$	$2.6 + j0.9$
410	$0.8 - j2.1$	$3 + j0.5$

Figure 2. Series Equivalent Input and Output Impedances

## TYPICAL CHARACTERISTICS

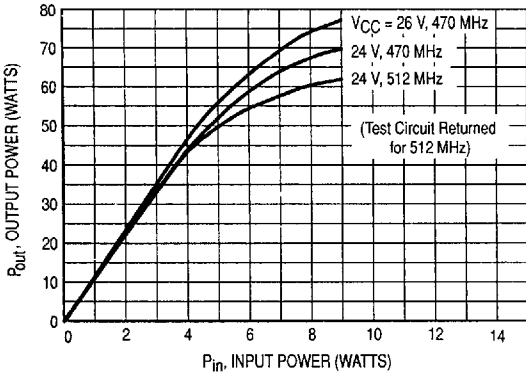

Figure 3. Output Power versus Input Power

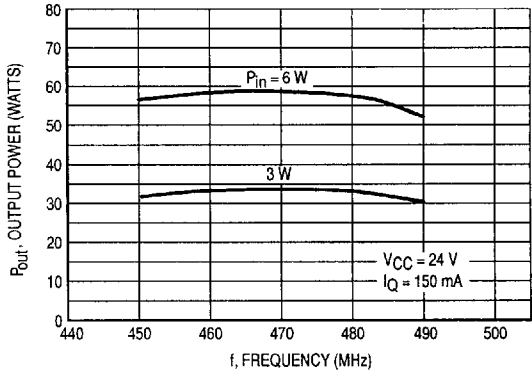

Figure 4. Output Power versus Frequency

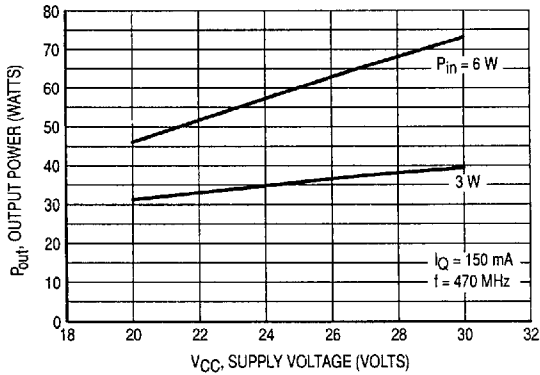

Figure 5. Output Power versus Supply Voltage

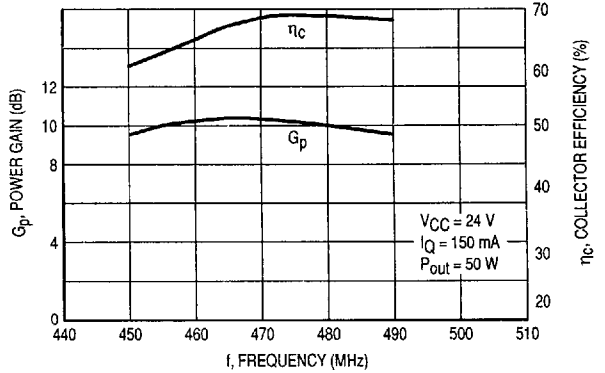
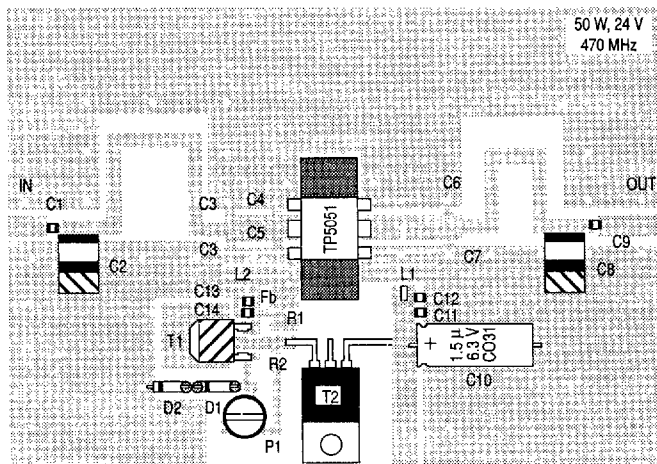

Figure 6. Power Gain, Collector Efficiency versus Frequency



EPOXY GLASS 1/16 INCH  $\epsilon_r = 4.5$

Figure 7. 470 MHz Test Circuit Components View