

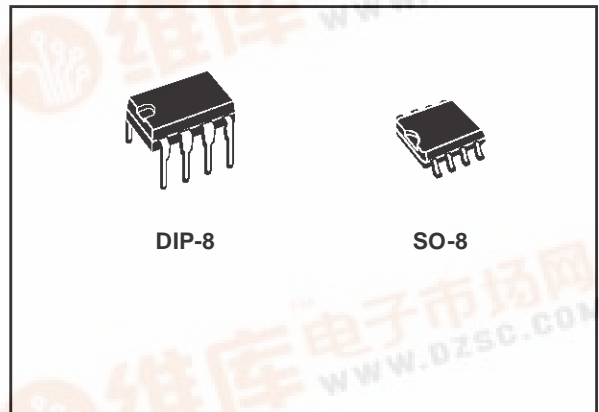

# ST619LB SERIES

## DC-DC CONVERTER REGULATED 5V CHARGE PUMP

- REGULATED 5V  $\pm 4\%$  CHARGE PUMP
- OUTPUT CURRENT GUARANTEED OVER TEMPERATURE : 20mA ( $V_I \geq 2V$ ), 30mA ( $V_I \geq 3V$ )
- NO INDUCTORS; VERY LOW EMI NOISE
- USES SMALL, INEXPENSIVE CAPACITORS
- LOGIC CONTROLLED 1 $\mu$ A MAX SHUT-DOWN SUPPLY CURRENT
- SHUT DOWN DISCONNECTS LOAD FROM INPUT
- AVAILABLE IN SO-8 AND DIP-8 PACKAGES



### DESCRIPTION

The ST619LB is a step-up charge pump DC-DC converter which delivers a regulated 5V  $\pm 4\%$  output at 30mA and over temperature. The input voltage range is 2V to 3.6V (two battery cells). It requires only four external capacitor: two 0.22 $\mu$ F flying capacitors, and 10 $\mu$ F capacitors at the input and output.

Low operating supply current (typ 200 $\mu$ A) make the device ideal for small, portable and battery powered applications. When shut down the load is disconnected from the input and the supply current is typically 0.02 $\mu$ A. The ST619LB is available in SO-8 and DIP-8 packages.

### SCHEMATIC DIAGRAM

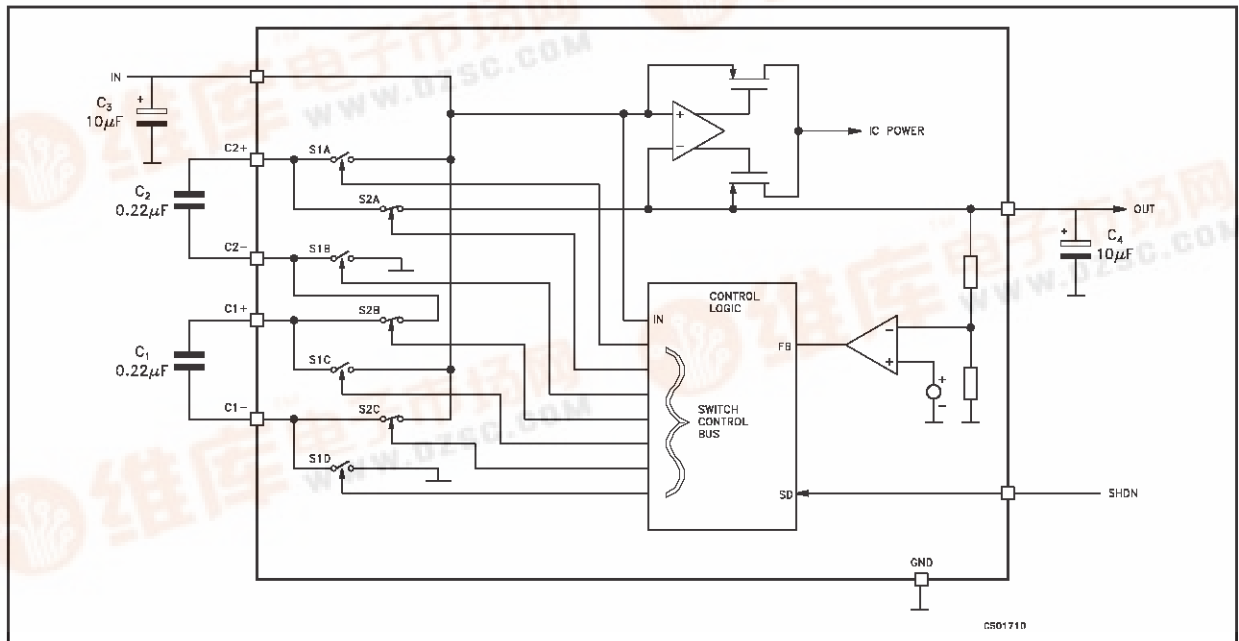

**OPERATING PRINCIPLE**

The ST619LB is able to provide a regulated 5V output from a 2V to 3.6V (two battery cells) input. Internal charge pump and external capacitors generate the 5V output, eliminating the need for inductors. The output voltage is regulated to 5V,  $\pm 4\%$  by a pulse skipping controller that turns on the charge pump when the output voltage begins to drop. To maintain the greatest efficiency the internal charge pump of the device operates as a voltage doubler when  $V_I$  ranges from 3.0V to 3.6V and as a voltage tripler when  $V_I$  ranges from 2.0V to 2.5V.

When  $V_I$  ranges from 2.5V to 3.0V, the ST619LB switches between doubler and tripler mode on alternating cycles, making a  $2.5 \times V_I$  charge pump. To further enhance the efficiency over the input range, an internal comparator selects the higher of  $V_I$  or  $V_O$  to run the ST619LB's circuitry. With  $V_I = 2V$  and  $I_O = 20mA$  the typical efficiency value is 80%.

In tripler mode (see block diagram), when the S1 switches close, the S2 switches open and

capacitors C1 and C2 charge up to  $V_I$ . On the second half of the cycle, C1 and C2 are connected in series between IN and OUT when the S1 switches open and S2 switches close. In the doubler mode only C2 is used. During one oscillator cycle, energy is transferred from the input to the charge pump capacitors, and then from the charge pump capacitors to the output capacitors and load. The number of cycles within a given time frame increases as the load increases or as the input supply voltage decreases. In the limiting case, the charge pumps operate continuously, and the oscillator frequency is nominally 500kHz.

**Shut Down Mode**

The ST619LB enters low power shut down mode when SHDN is a logic high. In shut down mode, OUT is disconnected from the IN and  $V_O$  falls to 0V. The SHDN pin is connected to ground for normal operation. SHDN is a CMOS compatible input.

**ABSOLUTE MAXIMUM RATINGS**

Symbol	Parameter	Value	Unit
$V_I$	DC Input Voltage	-0.3 to 5.5	V
$V_O$	Output Voltage	-0.3 to 5.5	V
$V_{SHDN}$	Shutdown Input Voltage	-0.3 to ( $V_I + 0.3$ )	V
$I_O$	Output Current Continuous	120	mA
$T_{stg}$	Storage Temperature Range	-55 to +150	°C
$T_{op}$	Operating Junction Temperature Range	-40 to +85	°C

Absolute Maximum Ratings are those values beyond which damage to the device may occur. Functional operation under these condition is not implied.

**THERMAL DATA**

Symbol	Parameter	SO-8	DIP-8	Unit
$R_{thj-amb}$	Thermal Resistance Junction-ambient (*)	160	100	°C/W

(\*) This value depends from thermal design of PCB on which the device is mounted.

CONNECTION DIAGRAM (top view)

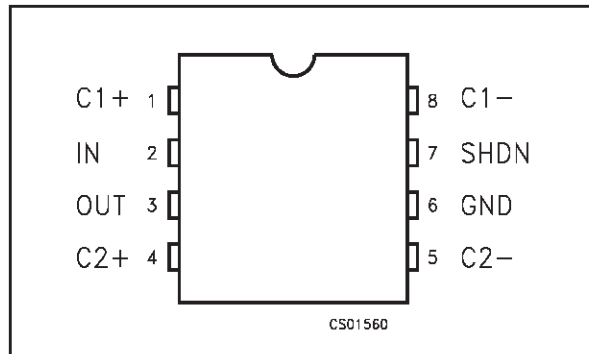

PIN DESCRIPTION

Pin N°	Symbol	Name and Function
1	C1+	Positive terminal for the first charge pump capacitor
2	IN	Input supply voltage
3	OUT	5V output voltage. $V_O=0V$ when in shutdown mode.
4	C2+	Positive terminal for the second charge pump capacitor
5	C2-	Negative terminal for the second charge pump capacitor
6	GND	Ground
7	SHDN	Active high C-MOS logic level shutdown input. SHDN is connected to GND for normal operation.
8	C1-	Negative terminal for the first charge pump capacitor

ORDERING CODES

TYPE	DIP-8	SO-8	SO-8 (T&R)
ST619LB	ST619LBN	ST619LBD	ST619LBDR

**ELECTRICAL CHARACTERISTICS** ( $V_I=2$  to  $3.6V$ ,  $C_1 = C_2 = 0.22\mu F$ ,  $C_3 = C_4 = 10\mu F$ ,  $T_A = -40$  to  $85^\circ C$ , unless otherwise specified. Typical value are referred at  $T_A = 25^\circ C$ )

Symbol	Parameter	Test Conditions	Min.	Typ.	Max.	Unit
$V_I$	Input Voltage		2		3.6	V
$V_O$	Output Voltage	$V_I = 2$ to $3.6V$ $I_O = 0$ to $20mA$ $V_I = 3$ to $3.6V$ $I_O = 0$ to $30mA$	4.8 4.8	5 5	5.2 5.2	V V
$V_{RIPPLE}$	Output Voltage Ripple	No load, Full Load		100		mV
$I_i$	No Load Supply Current	$V_I = 2$ to $3V$ No Load $V_I = 3$ to $3.6V$ No Load		200 75	300 150	$\mu A$ $\mu A$
$I_{SHDN}$	Shutdown Supply Current	$V_I = 2$ to $3.6V$ No Load $V_{SHDN} = V_I$		0.02	1	$\mu A$
$\nu$	Efficiency	$V_I = 3V$ $I_O = 20mA$ $V_I = 3V$ $I_O = 30mA$ $V_I = 2V$ $I_O = 20mA$		82 82 80		% % %
$f_{OSC}$	Switching Frequency	Full Load		500		KHz
$V_{IH}$	SHDN Input Threshold		$0.7V_I$			V
$V_{IL}$	SHDN Input Threshold				0.4	V
$I_{IH}$	SHDN Input Current	$V_{SHDN} = V_I$		0.005	$\pm 1$	$\mu A$

Note: Do not overload or short the Output to Ground. If the above conditions are not observed the device may be damaged.

**TYPICAL PERFORMANCE CHARACTERISTICS** (unless otherwise specified  $T_A = 25^\circ\text{C}$ )

**Figure 1 :** No Load Supply Current vs Input Voltage

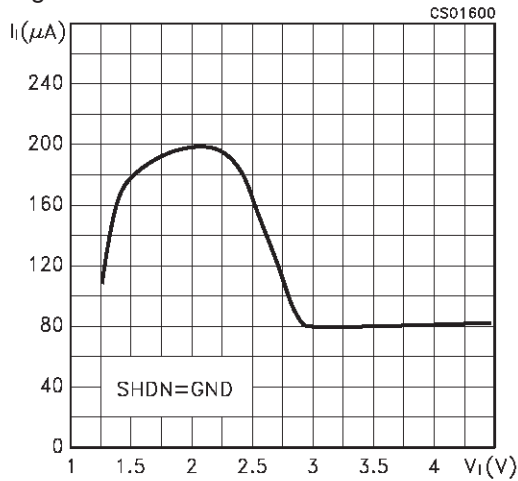

**Figure 2 :** Shutdown Supply Current vs Input Voltage

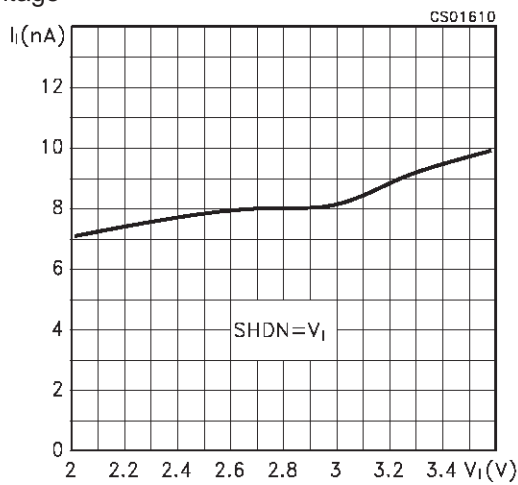

**Figure 3 :** Maximum Output Current vs Input Voltage

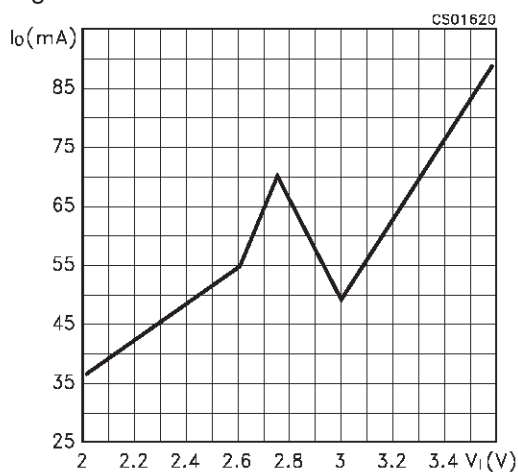

**Figure 4 :** Output Voltage vs Output Current

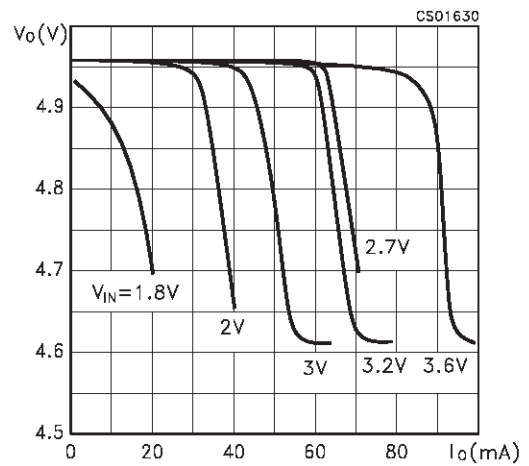

**Figure 5 :** Efficiency vs Output Current

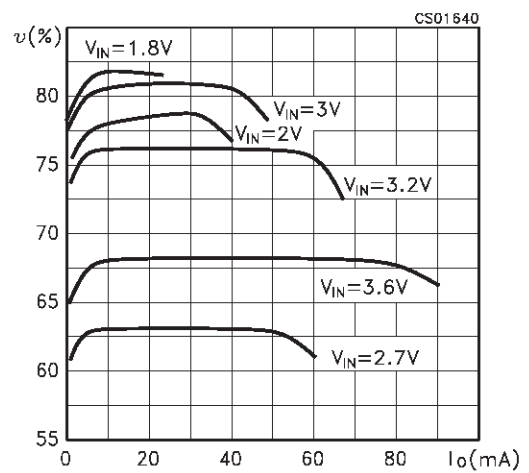

**Figure 6 :** Efficiency vs Input Voltage

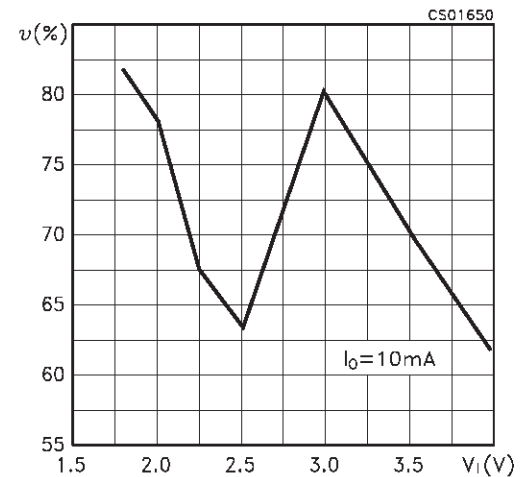

Figure 7 : Output Voltage vs Input Voltage

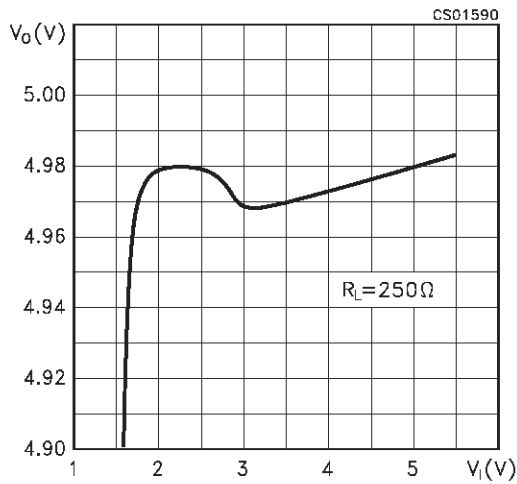

Figure 8 : Start-up

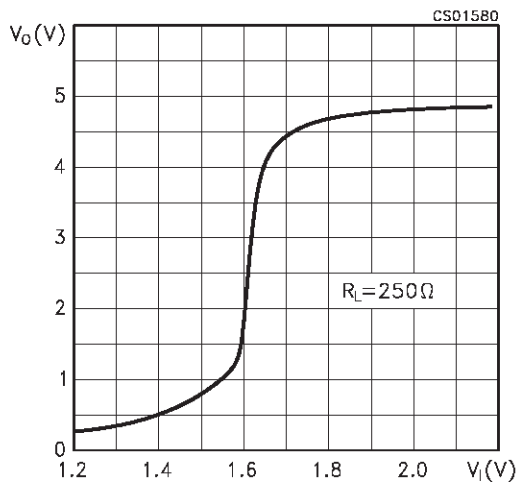

Figure 9 : Output Voltage vs Temperature

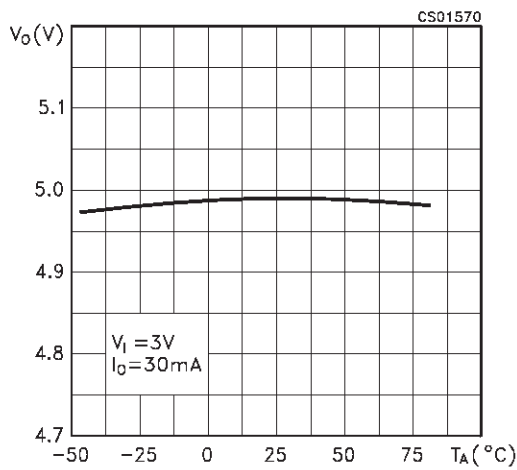

Figure 10 : Line Transient Response

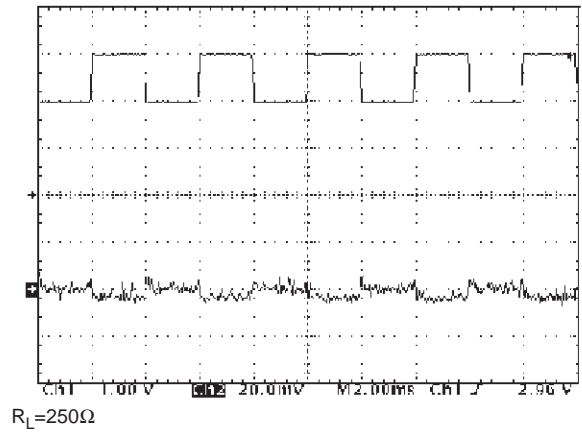
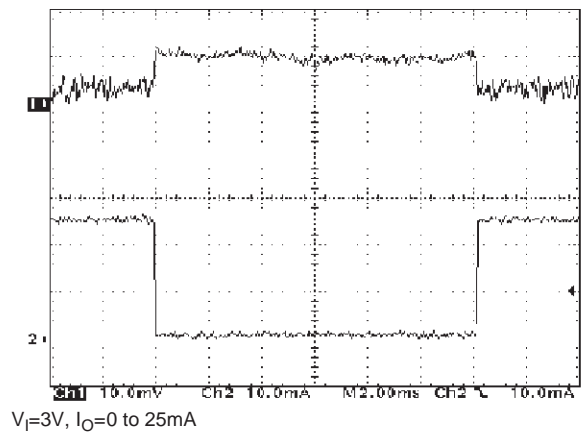

Figure 11 : Load Transient Response



## ST619LB SERIES

### APPLICATION INFORMATION

#### Charge pump capacitors C1 and C2

The values of charge pump capacitors C1 and C2 are critical to ensure adequate output current and avoid excessive peak currents. It is suggested to use values in the range of  $0.22\mu\text{F}$  to  $1.0\mu\text{F}$  and avoid the use of higher values of  $C_O$  capacitors, in order to obtain best performance. Ceramic or tantalum capacitors are recommended.

#### Input and output capacitors C3 and C4

The type of input capacitor (C3) and output filter capacitor (C4) used is not critical, but it does affect performance. Tantalums, ceramics or aluminium electrolytic are suggested. For lowest ripple, use large, low effective series resistance (ESR) ceramic tantalum capacitors. If the input supply

source impedance is very low, C3 can be omitted. The typical application circuit shows the component values for proper operation using minimal board space. The input bypass capacitor (C3) and output filter capacitor (C4) should be at least  $10\mu\text{F}$ . Many capacitors exhibit 40% to 50% variation over temperature. Compensate for capacitor temperature coefficient by selecting a large nominal value to ensure proper operation over temperature.

#### Layout Consideration

In the below figure, the typical application demoboard of ST619LB is reported. A good layout ensures stability and helps maintain the output voltage under heavy loads. For best performance, use very short connections to the capacitors.

### TYPICAL APPLICATION CIRCUIT

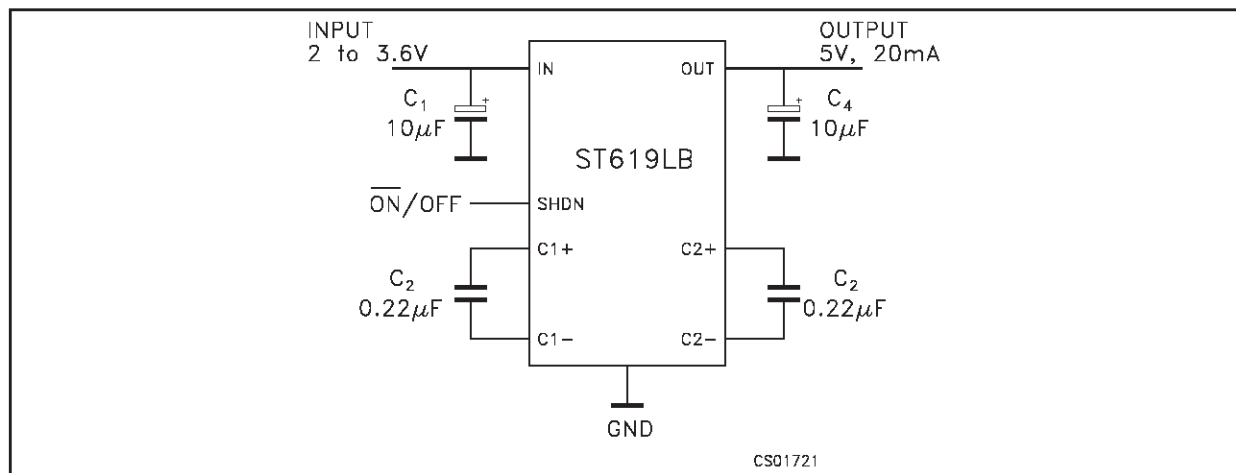

### TYPICAL APPLICATION DEMOBOARD

