



Advanced Power MOSFET

SSW/I4N80AS

FEATURES

- Avalanche Rugged Technology
- Rugged Gate Oxide Technology
- Lower Input Capacitance
- Improved Gate Charge
- Extended Safe Operating Area
- Lower Leakage Current : 25  $\mu$ A (Max.) @  $V_{DS} = 800V$
- Low  $R_{DS(ON)}$  : 2.450  $\Omega$  (Typ.)<sub>c</sub>

$BV_{DSS} = 800 V$
$R_{DS(on)} = 3.0 \Omega$
$I_D = 4.5 A$

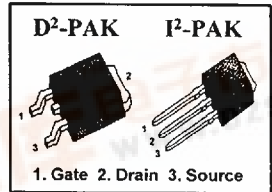

Absolute Maximum Ratings

Symbol	Characteristic	Value	Units
$V_{DSS}$	Drain-to-Source Voltage	800	V
$I_D$	Continuous Drain Current ( $T_c=25^\circ C$ )	4.5	A
	Continuous Drain Current ( $T_c=100^\circ C$ )	2.8	
$I_{DM}$	Drain Current-Pulsed ①	18	A
$V_{GS}$	Gate-to-Source Voltage	$\pm 30$	V
$E_{AS}$	Single Pulsed Avalanche Energy ②	324	mJ
$I_{AR}$	Avalanche Current ①	4.5	A
$E_{AR}$	Repetitive Avalanche Energy ①	13	mJ
$dv/dt$	Peak Diode Recovery $dv/dt$ ③	2.0	V/ns
$P_D$	Total Power Dissipation ( $T_c=25^\circ C$ )	3.1	W
	Linear Derating Factor	130	
$T_J, T_{STG}$	Operating Junction and Storage Temperature Range	1.04	°C
		- 55 to +150	
$T_L$	Maximum Lead Temp. for Soldering Purposes, 1/8" from case for 5-seconds	300	

Thermal Resistance

Symbol	Characteristic	Typ.	Max.	Units
$R_{\theta JC}$	Junction-to-Case	--	0.96	°C/W
$R_{\theta JA}$	Junction-to-Ambient *	--	40	
$R_{\theta JA}$	Junction-to-Ambient	--	62.5	

\* When mounted on the minimum pad size recommended (PCB Mount).



# SSW/I4N80AS

## N-CHANNEL POWER MOSFET

### Electrical Characteristics ( $T_C=25^\circ\text{C}$ unless otherwise specified)

Symbol	Characteristic	Min.	Typ.	Max.	Units	Test Condition
$BV_{DSS}$	Drain-Source Breakdown Voltage	800	--	--	V	$V_{GS}=0V, I_D=250\mu\text{A}$
$\Delta BV/\Delta T_J$	Breakdown Voltage Temp. Coeff.	--	0.96	--	$V/^\circ\text{C}$	$I_D=250\mu\text{A}$ See Fig 7
$V_{GS(th)}$	Gate Threshold Voltage	2.0	--	3.5	V	$V_{DS}=5V, I_D=250\mu\text{A}$
$I_{GSS}$	Gate-Source Leakage, Forward	--	--	100	nA	$V_{GS}=30V$
	Gate-Source Leakage, Reverse	--	--	-100	nA	$V_{GS}=-30V$
$I_{DSS}$	Drain-to-Source Leakage Current	--	--	25	$\mu\text{A}$	$V_{DS}=800V$
		--	--	250		$V_{DS}=640V, T_C=125^\circ\text{C}$
$R_{DS(on)}$	Static Drain-Source On-State Resistance	--	--	3.0	$\Omega$	$V_{GS}=10V, I_D=0.85A$ ④*
$g_{fs}$	Forward Transconductance	--	3.47	--	$\text{S}$	$V_{DS}=50V, I_D=0.85A$ ④
$C_{iss}$	Input Capacitance	--	880	1140	pF	$V_{GS}=0V, V_{DS}=25V, f=1\text{MHz}$ See Fig 5
$C_{oss}$	Output Capacitance	--	90	105		
$C_{rss}$	Reverse Transfer Capacitance	--	35	42		
$t_{d(on)}$	Turn-On Delay Time	--	19	50	ns	$V_{DD}=400V, I_D=2A,$ $R_G=16\Omega$ See Fig 13 ④ ⑤
$t_r$	Rise Time	--	32	75		
$t_{d(off)}$	Turn-Off Delay Time	--	67	145		
$t_f$	Fall Time	--	32	75		
$Q_g$	Total Gate Charge	--	40	52	nC	$V_{DS}=640V, V_{GS}=10V,$ $I_D=2A$ See Fig 6 & Fig 12 ④ ⑤
$Q_{gs}$	Gate-Source Charge	--	7.3	--		
$Q_{gd}$	Gate-Drain("Miller") Charge	--	18.1	--		

### Source-Drain Diode Ratings and Characteristics

Symbol	Characteristic	Min.	Typ.	Max.	Units	Test Condition
$I_S$	Continuous Source Current	--	--	4.5	A	Integral reverse pn-diode in the MOSFET
$I_{SM}$	Pulsed-Source Current ①	--	--	18		
$V_{SD}$	Diode Forward Voltage ④	--	--	1.4	V	$T_J=25^\circ\text{C}, I_S=4.5A, V_{GS}=0V$
$t_{rr}$	Reverse Recovery Time	--	430	--	ns	$T_J=25^\circ\text{C}, I_F=4.5A$
$Q_{rr}$	Reverse Recovery Charge	--	4.06	--	$\mu\text{C}$	$di_F/dt=100A/\mu\text{s}$ ④

#### Notes :

- Repetitive Rating : Pulse Width Limited by Maximum Junction Temperature
- $L=3\text{mH}, I_{AS}=4.5A, V_{DD}=50V, R_G=27\Omega,$  Starting  $T_J=25^\circ\text{C}$
- $I_{SD}\leq 4.5A, di/dt \leq 120A/\mu\text{s}, V_{DD} \leq BV_{DSS},$  Starting  $T_J=25^\circ\text{C}$
- Pulse Test : Pulse Width =  $250\mu\text{s},$  Duty Cycle  $\leq 2\%$
- Essentially Independent of Operating Temperature

N-CHANNEL  
POWER MOSFET

SSW/I4N80AS

Fig 1. Output Characteristics

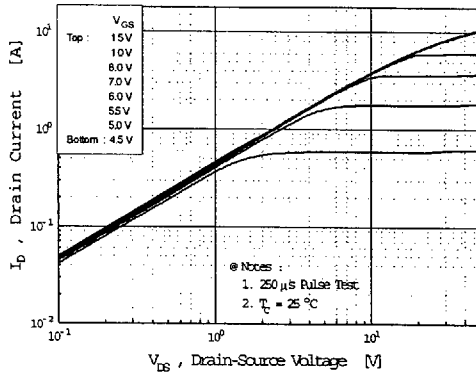

Fig 2. Transfer Characteristics

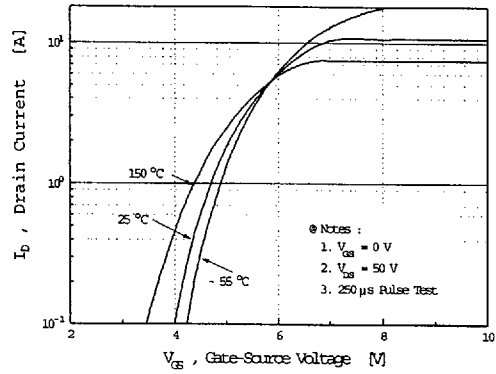

Fig 3. On-Resistance vs. Drain Current

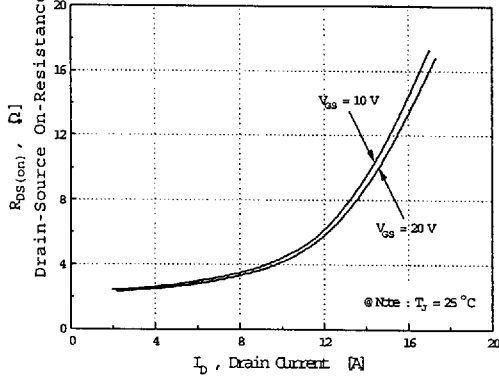

Fig 4. Source-Drain Diode Forward Voltage

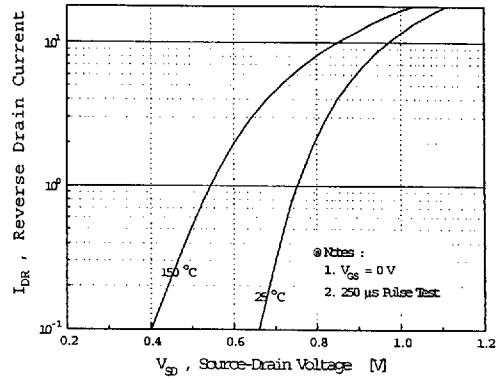

Fig 5. Capacitance vs. Drain-Source Voltage

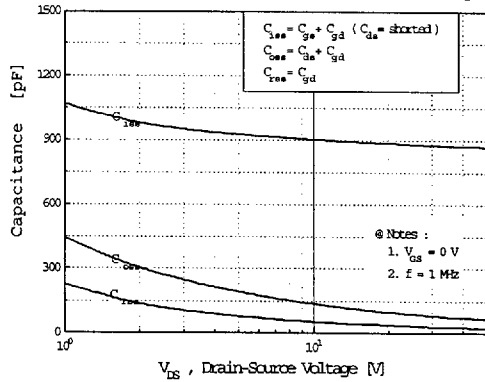
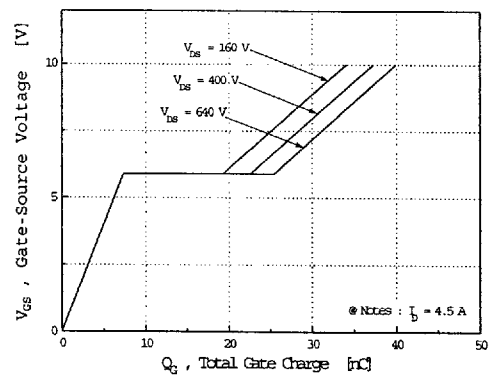

Fig 6. Gate Charge vs. Gate-Source Voltage



# SSW/I4N80AS

N-CHANNEL  
POWER MOSFET

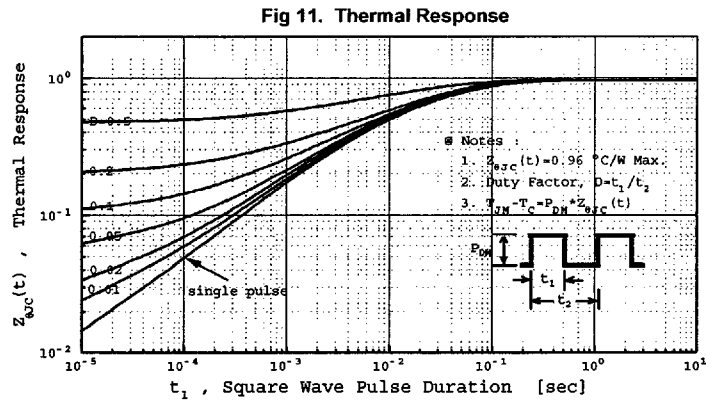
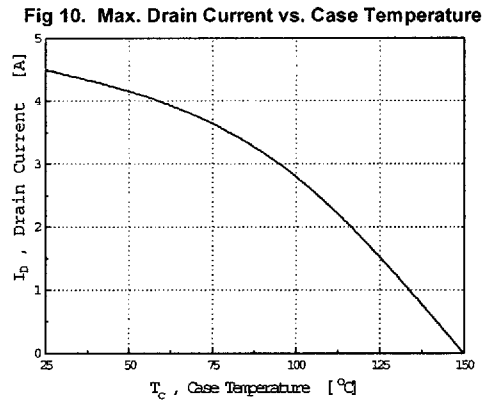
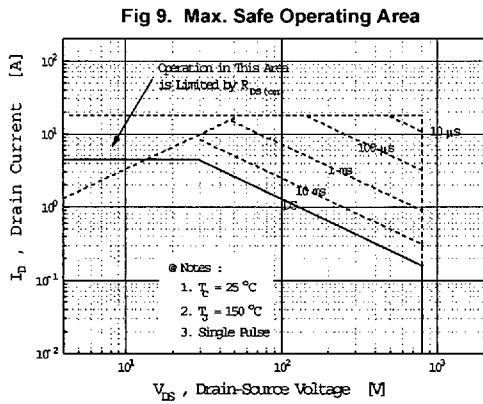
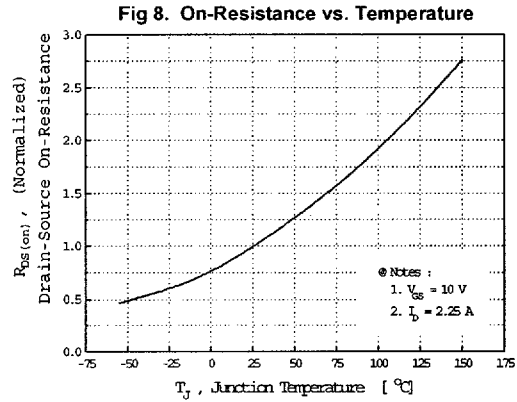
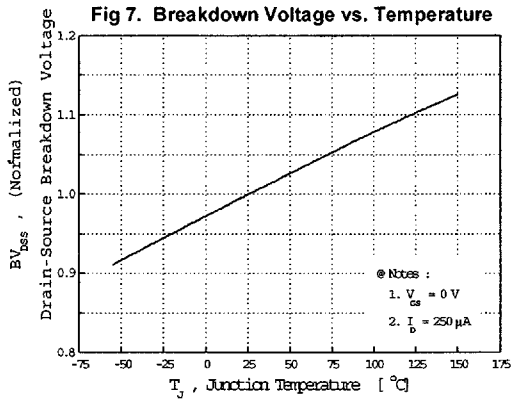

Fig 12. Gate Charge Test Circuit & Waveform

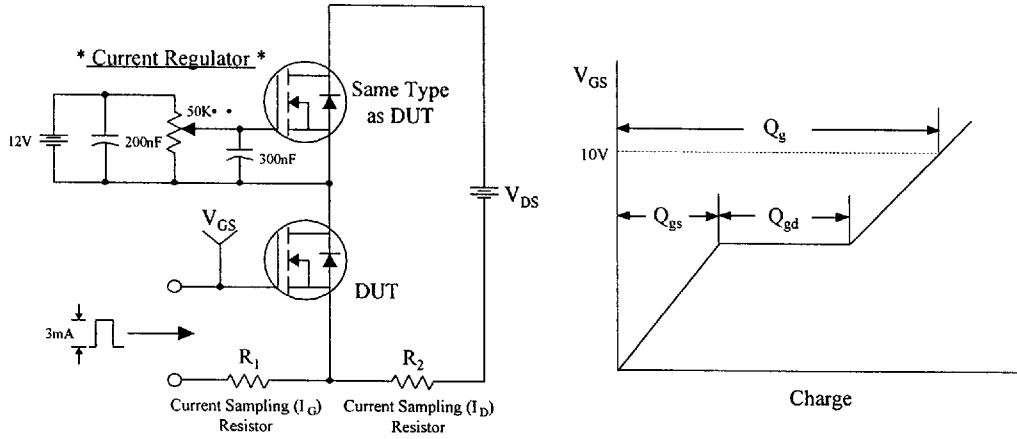

Fig 13. Resistive Switching Test Circuit & Waveforms

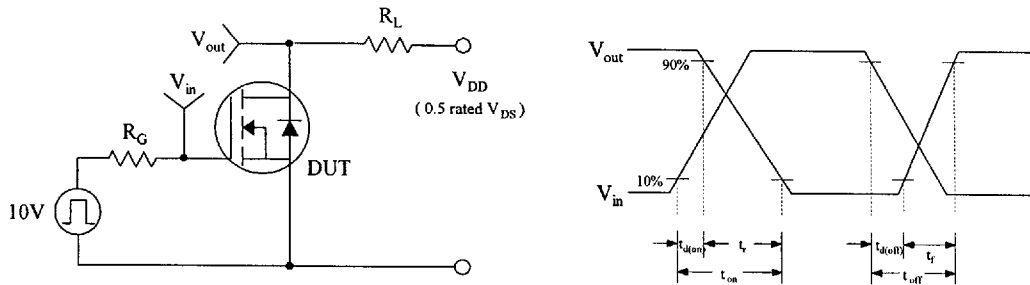

Fig 14. Unclamped Inductive Switching Test Circuit & Waveforms

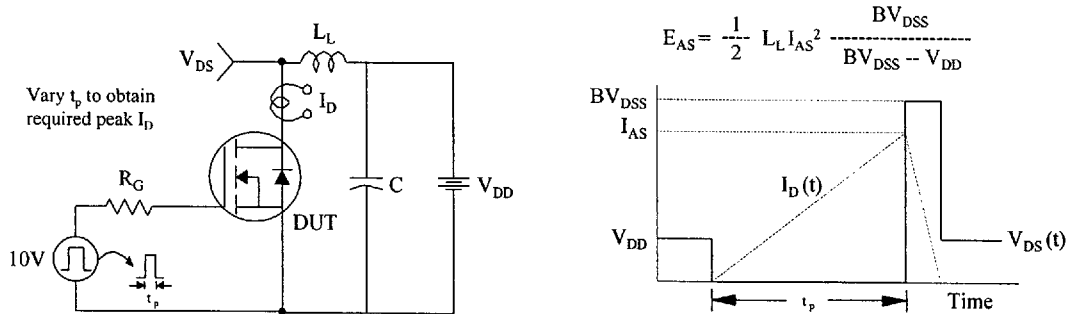

Fig 15. Peak Diode Recovery dv/dt Test Circuit & Waveforms

