

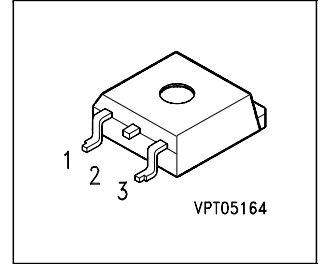

SPP11N60S5
SPB11N60S5

Cool MOS™ Power-Transistor

- New revolutionary high voltage technology
- Ultra low gate charge
- Periodic avalanche rated
- Extreme dv/dt rated
- Optimized capacitances
- Improved noise immunity
- Former development designation:
SPPx2N60S5/SPBx2N60S5

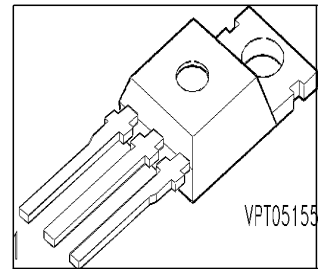
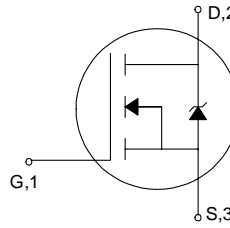

Type	V_{DS}	I_D	$R_{DS(on)}$	Package	Marking	Ordering Code
SPP11N60S5	600 V	11 A	0.38 Ω	P-TO220-3-1	11N60S5	Q67040-S4198
SPB11N60S5				P-TO263-3-2	11N60S5	Q67040-S4199

Maximum Ratings, at $T_j = 25\text{ }^\circ\text{C}$, unless otherwise specified

Parameter	Symbol	Value	Unit
Continuous drain current $T_C = 25\text{ }^\circ\text{C}$ $T_C = 100\text{ }^\circ\text{C}$	I_D	11 7	A
Pulsed drain current, $t_p = 1\text{ms}^1)$ $T_C = 25\text{ }^\circ\text{C}$	$I_{D\text{ puls}}$	22	
Avalanche energy, single pulse $I_D = 5.5\text{ A}$, $V_{DD} = 50\text{ V}$	E_{AS}	340	mJ
Avalanche energy (repetitive, limited by T_{jmax}) $I_D = 13.8\text{ A}$, $V_{DD} = 50\text{ V}$	E_{AR}	1	
Avalanche current (repetitive, limited by T_{jmax})	I_{AR}	13.8	A
Reverse diode dv/dt $I_S = 11\text{ A}$, $V_{DS} < V_{DSS}$, $di/dt = 100\text{ A}/\mu\text{s}$, $T_{jmax} = 150\text{ }^\circ\text{C}$	dv/dt	6	kV/ μs
Gate source voltage	V_{GS}	± 20	V
Power dissipation $T_C = 25\text{ }^\circ\text{C}$	P_{tot}	125	W
Operating and storage temperature	T_j, T_{stg}	-55... +150	$^\circ\text{C}$

Electrical Characteristics, at $T_j = 25\text{ °C}$, unless otherwise specified

Parameter	Symbol	Values			Unit
		min.	typ.	max.	

Thermal Characteristics

Thermal resistance, junction - case	R_{thJC}	-	-	1	K/W
Thermal resistance, junction - ambient (Leaded and through-hole packages)	R_{thJA}	-	-	62	
SMD version, device on PCB: @ min. footprint @ 6 cm ² cooling area ²⁾	R_{thJA}	-	-	62	
		-	35	-	

Static Characteristics, at $T_j = 25\text{ °C}$, unless otherwise specified

Drain-source breakdown voltage $V_{GS} = 0\text{ V}$, $I_D = 0.25\text{ mA}$	$V_{(BR)DSS}$	600	-	-	V
Gate threshold voltage, $V_{GS} = V_{DS}$ $I_D = 0.5\text{ mA}$, $T_j = 25\text{ °C}$	$V_{GS(th)}$	3.5	4.5	5.5	
Zero gate voltage drain current, $V_{DS} = V_{DSS}$ $V_{GS} = 0\text{ V}$, $T_j = 25\text{ °C}$ $V_{GS} = 0\text{ V}$, $T_j = 150\text{ °C}$	I_{DSS}	-	-	25 250	μA
Gate-source leakage current $V_{GS} = 20\text{ V}$, $V_{DS} = 0\text{ V}$	I_{GSS}	-	-	100	
Drain-source on-state resistance $V_{GS} = 10\text{ V}$, $I_D = 7\text{ A}$	$R_{DS(on)}$	-	0.34	0.38	Ω

¹current limited by T_{jmax}
² Device on 40mm*40mm*1.5mm epoxy PCB FR4 with 6 cm² (one layer, 70 μm thick) copper area for drain connection. PCB is vertical without blown air.

Electrical Characteristics, at $T_j = 25\text{ °C}$, unless otherwise specified

Parameter	Symbol	Conditions	Values			Unit
			min.	typ.	max.	
Dynamic Characteristics						
Transconductance	g_{fs}	$V_{DS} \geq 2 \cdot I_D \cdot R_{DS(on)max}$, $I_D = 7A$	-	6	-	S
Input capacitance	C_{iss}	$V_{GS} = 0V$, $V_{DS} = 25V$, $f = 1MHz$	-	1460	-	pF
Output capacitance	C_{oss}		-	610	-	
Reverse transfer capacitance	C_{rss}		-	21	-	
Turn-on delay time	$t_{d(on)}$	$V_{DD} = 350V$, $V_{GS} = 10V$, $I_D = 11A$, $R_G = 6.8\Omega$	-	130	-	ns
Rise time	t_r		-	35	-	
Turn-off delay time	$t_{d(off)}$		-	150	225	
Fall time	t_f		-	20	30	
Gate Charge Characteristics						
Gate to source charge	Q_{gs}	$V_{DD} = 350V$, $I_D = 11A$	-	10.5	-	nC
Gate to drain charge	Q_{gd}		-	24	-	
Total gate charge	Q_g	$V_{DD} = 350V$, $I_D = 11A$, $V_{GS} = 0$ to $10V$	-	41.5	54	
Reverse Diode						
Inverse diode continuous forward current	I_S	$T_C = 25\text{ °C}$	-	-	11	A
Inverse diode direct current, pulsed	I_{SM}		-	-	22	
Inverse diode forward voltage	V_{SD}	$V_{GS} = 0V$, $I_F = 11A$	-	1	1.2	V
Reverse recovery time	t_{rr}	$V_R = 350V$, $I_F = I_S$, $di_F/dt = 100A/\mu s$	-	650	1105	ns
Reverse recovery charge	Q_{rr}		-	7.9	-	μC

Power dissipation

$P_{tot} = f(T_C)$

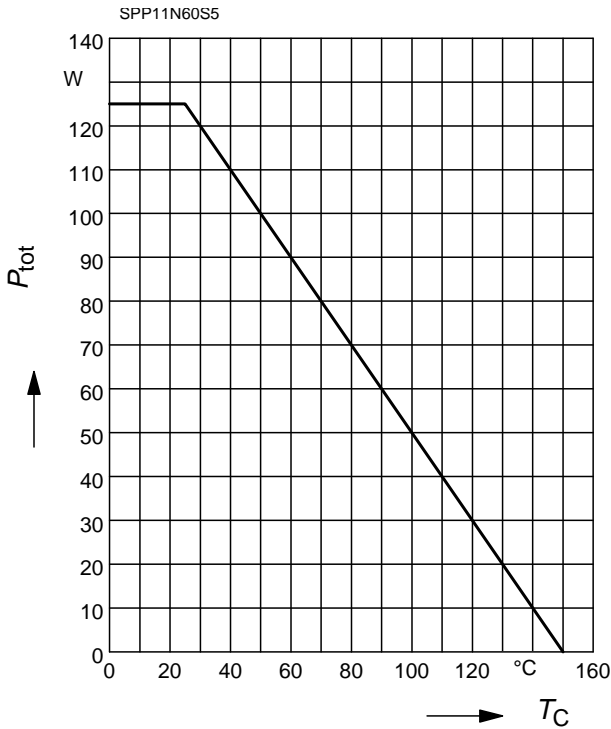

Drain current

$I_D = f(T_C)$

parameter: $V_{GS} \geq 10\text{ V}$

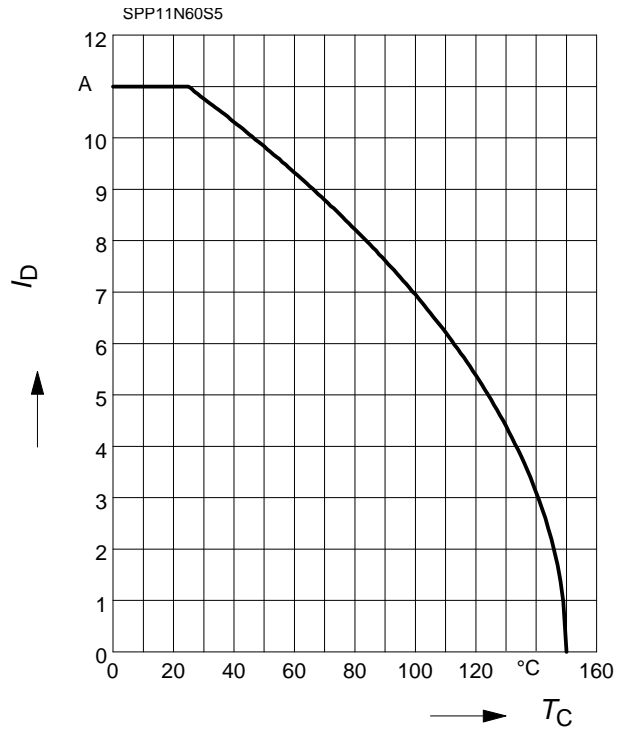

Safe operating area

$I_D = f(V_{DS})$

parameter: $D=0.01, T_C=25^\circ\text{C}$

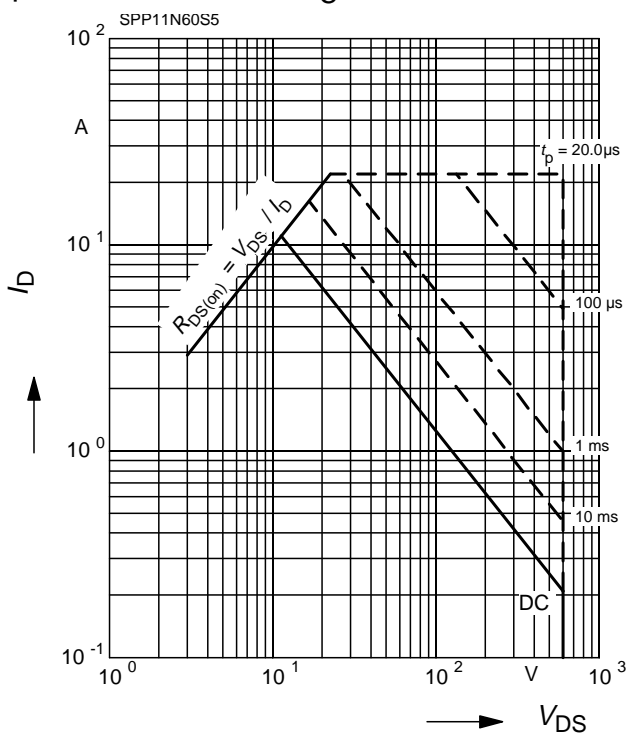

Transient thermal impedance

$Z_{thJC} = f(t_p)$

parameter: $D = t_p / T$

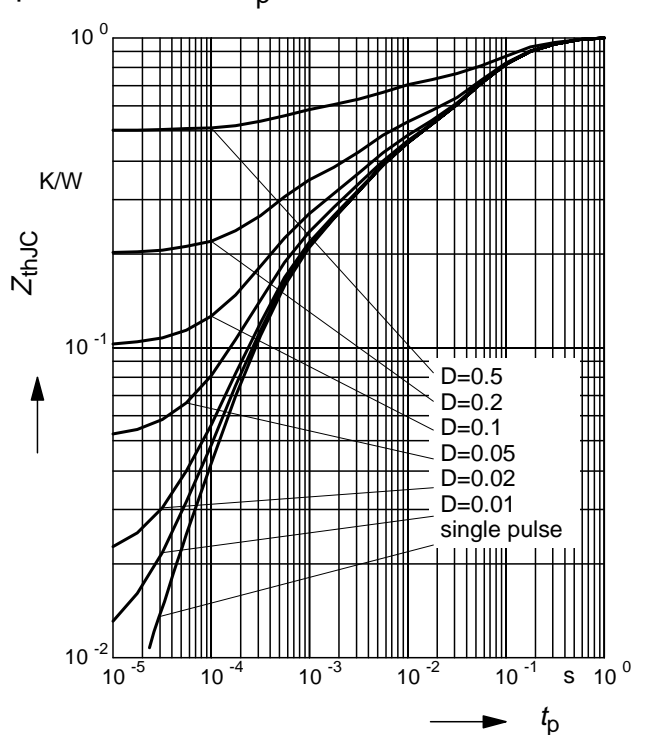

Typ. output characteristic

$I_D = f(V_{DS})$

Parameter: $V_{GS}, T_j = 25\text{ }^\circ\text{C}$

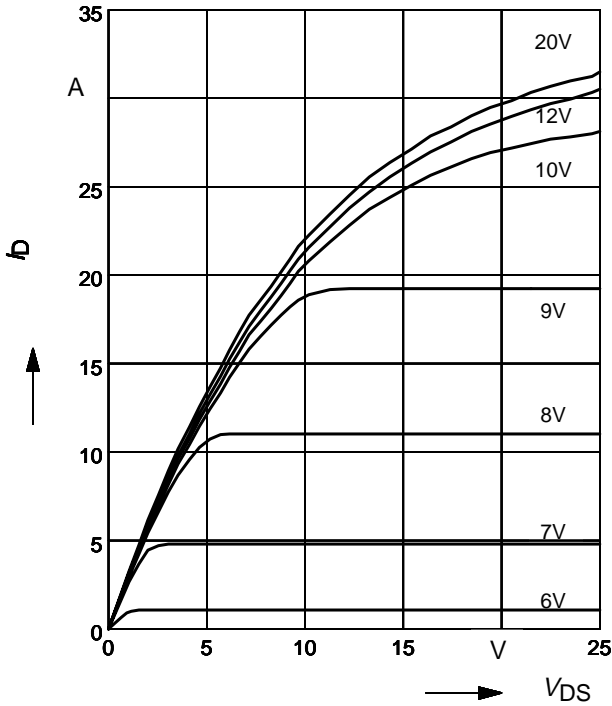

Drain-source on-resistance

$R_{DS(on)} = f(T_j)$

parameter: $I_D = 7\text{ A}, V_{GS} = 10\text{ V}$

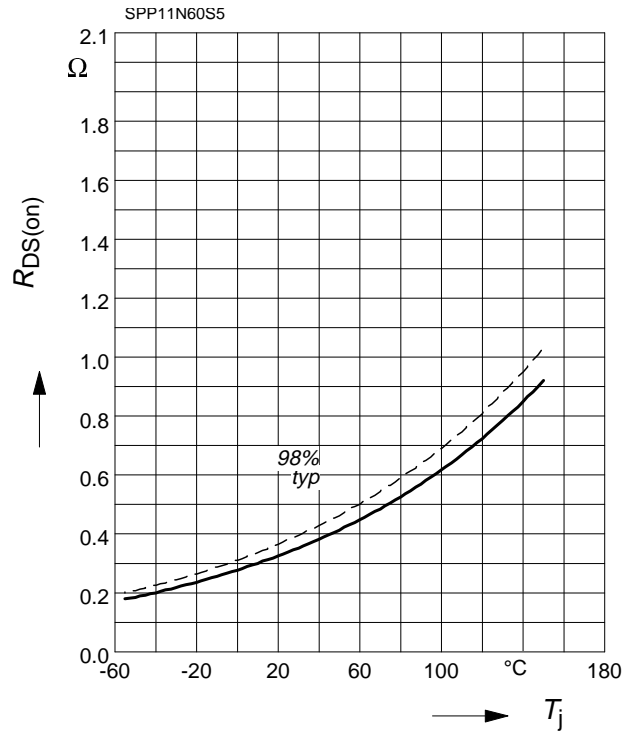

Typ. transfer characteristics

$I_D = f(V_{GS})$

$V_{DS} \geq 2 \times I_D \times R_{DS(on)max}$

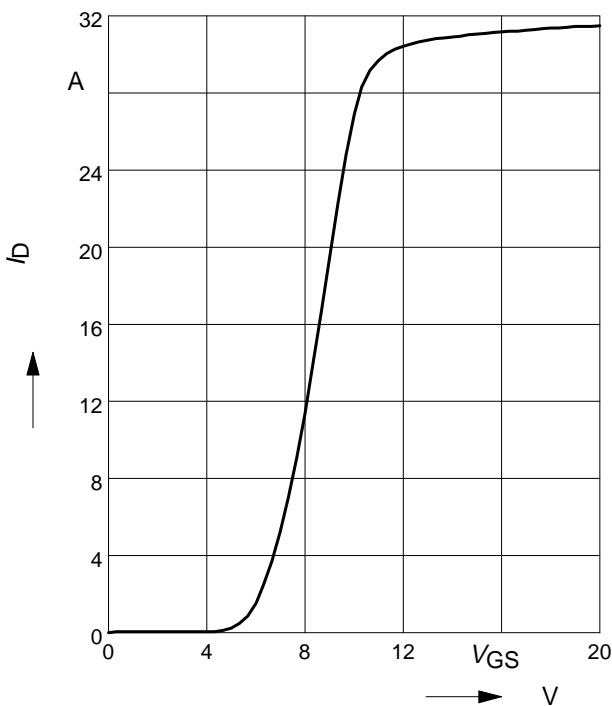

Typ. capacitances

$C = f(V_{DS})$

parameter: $V_{GS} = 0\text{ V}, f = 1\text{ MHz}$

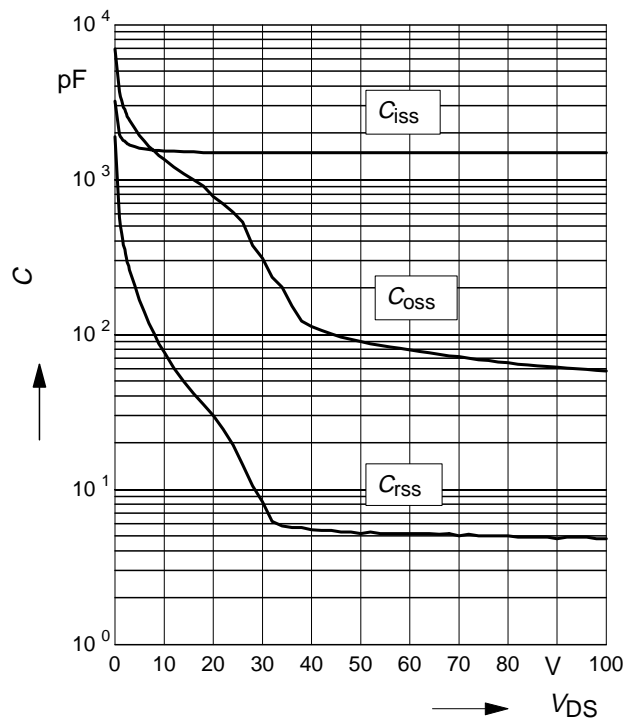

Avalanche energy

$$E_{AS} = f(T_j)$$

par.: $I_D=5.5A, V_{DD}=50V$

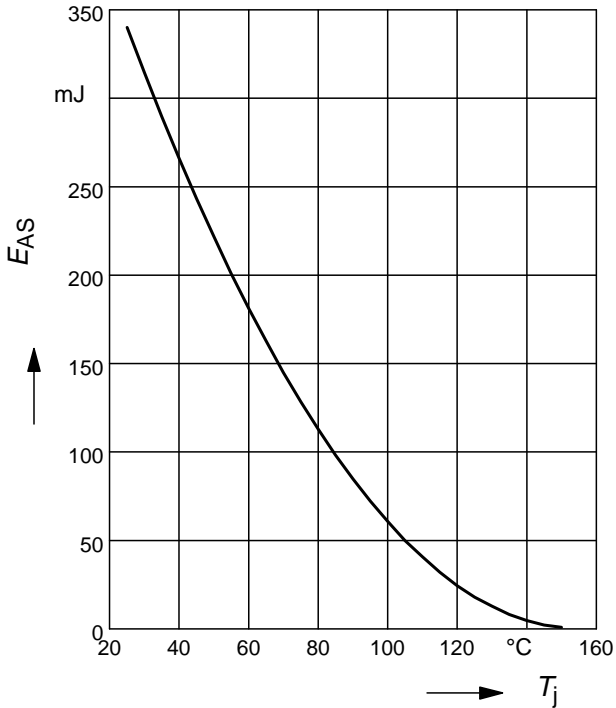

Avalanche SOA

$$I_{AR} = f(t_{AR})$$

par.: $T_{j(START)} = 25\text{ °C}, T_j \leq 150\text{ °C}$

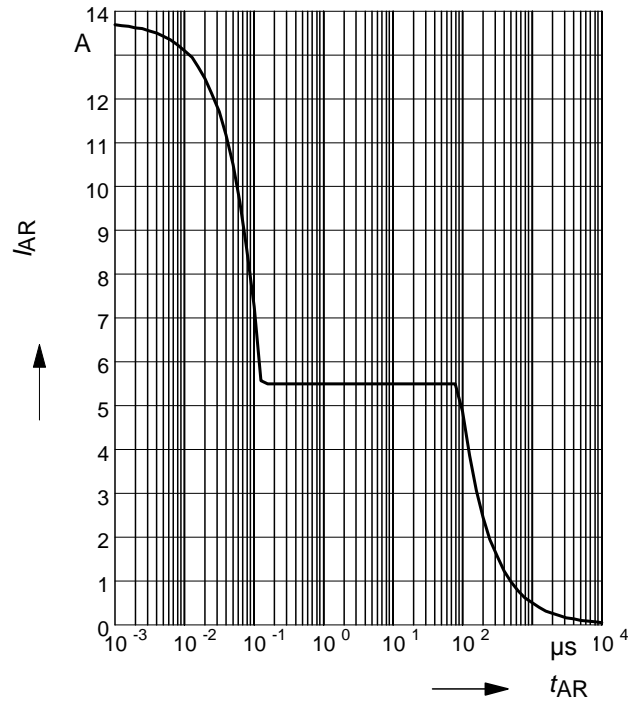

Drain-source breakdown voltage

$$V_{(BR)DSS} = f(T_j)$$

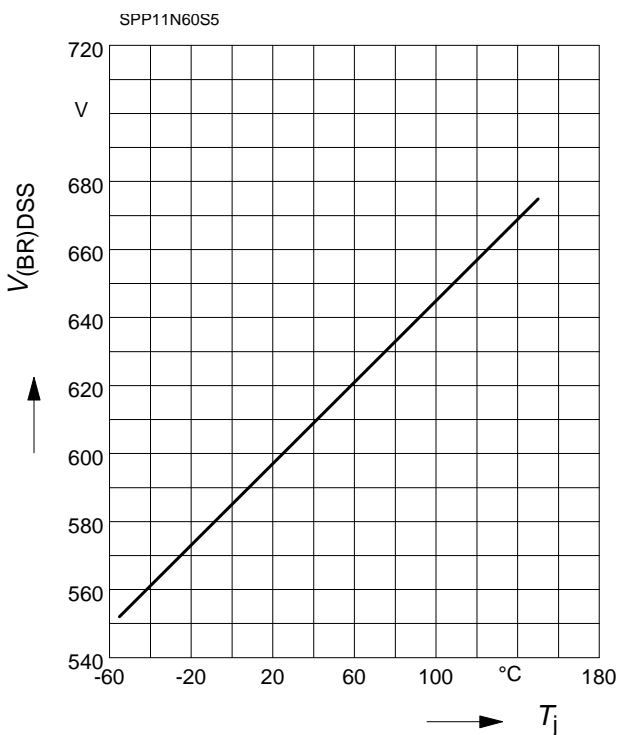

Gate threshold voltage

$$V_{GS(th)} = f(T_j)$$

parameter: $V_{GS} = V_{DS}, I_D = 0.5\text{ mA}$

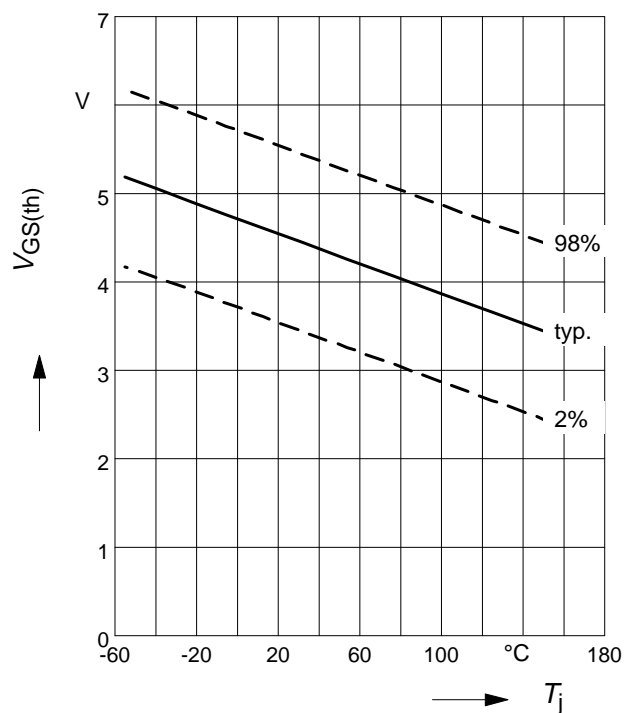

Forward characteristics of reverse diode

$$I_F = f(V_{SD})$$

parameter: T_j , $t_p = 80 \mu s$

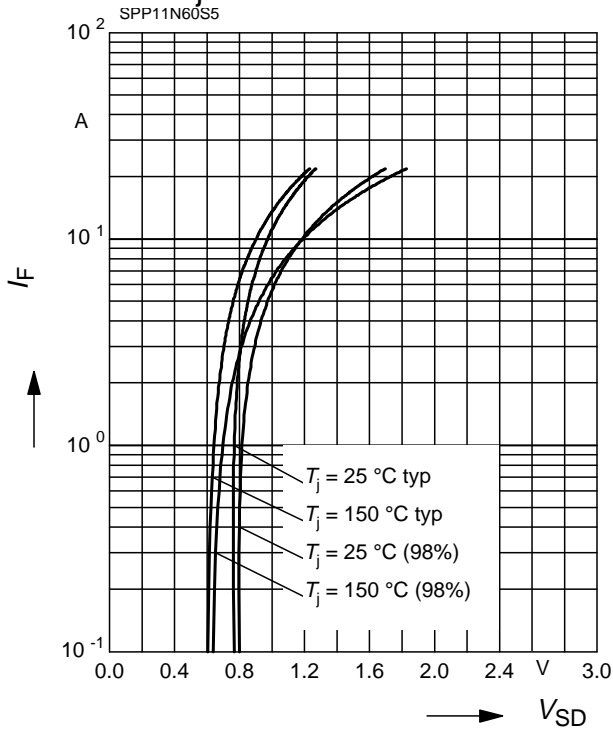

Typ. gate charge

$$V_{GS} = f(Q_{Gate})$$

parameter: $I_D = 11 \text{ A pulsed}$

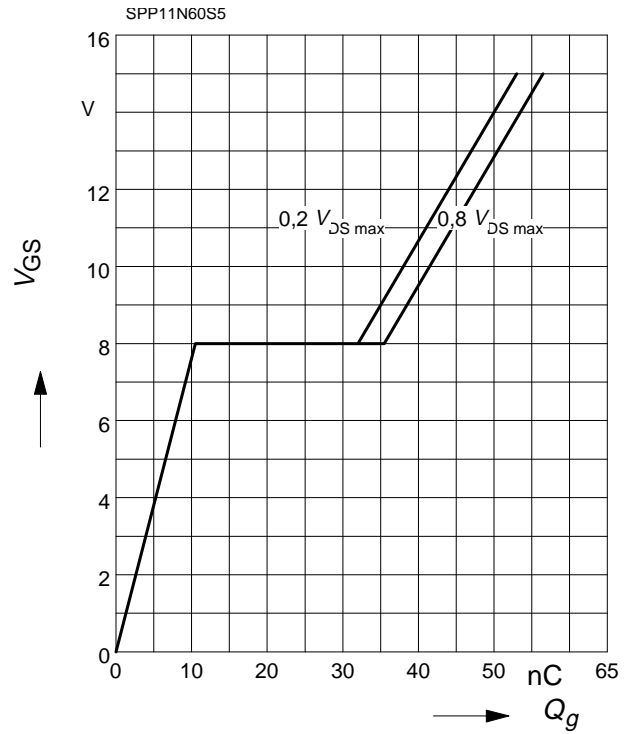

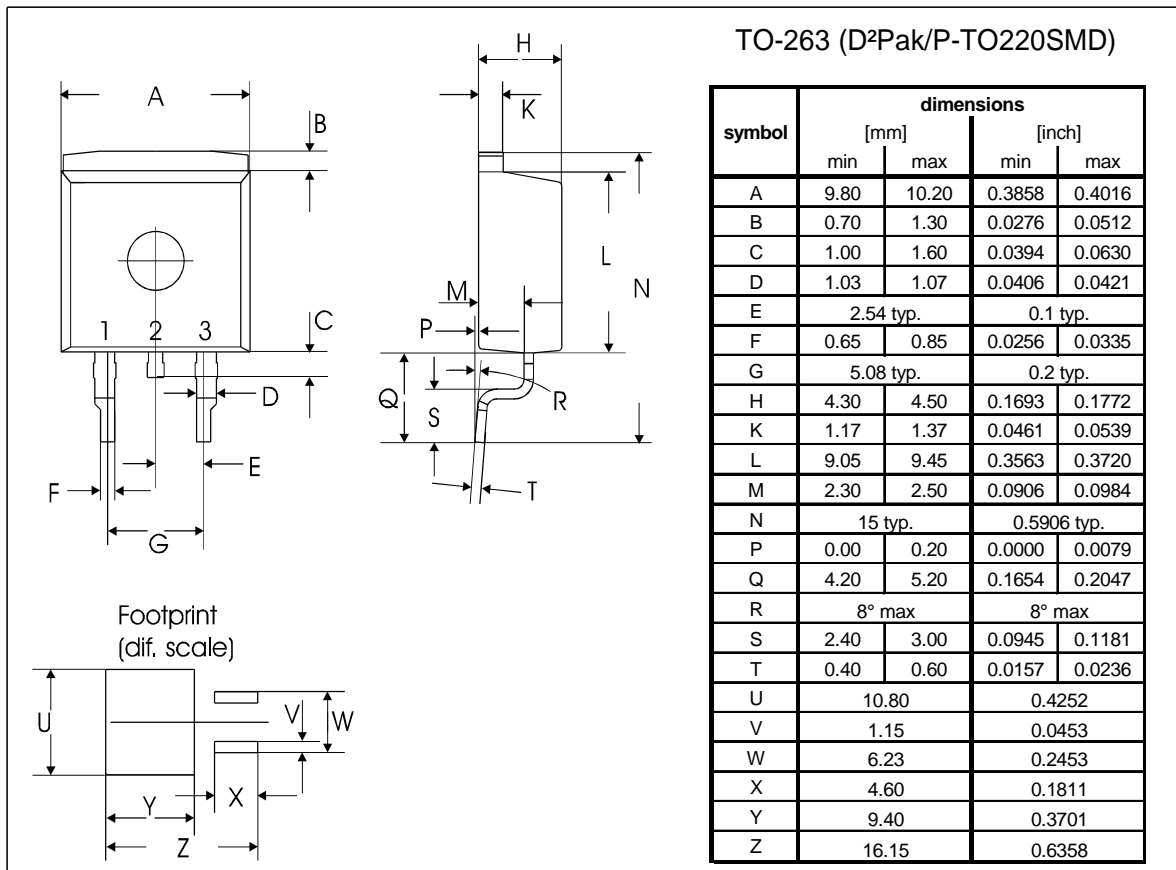
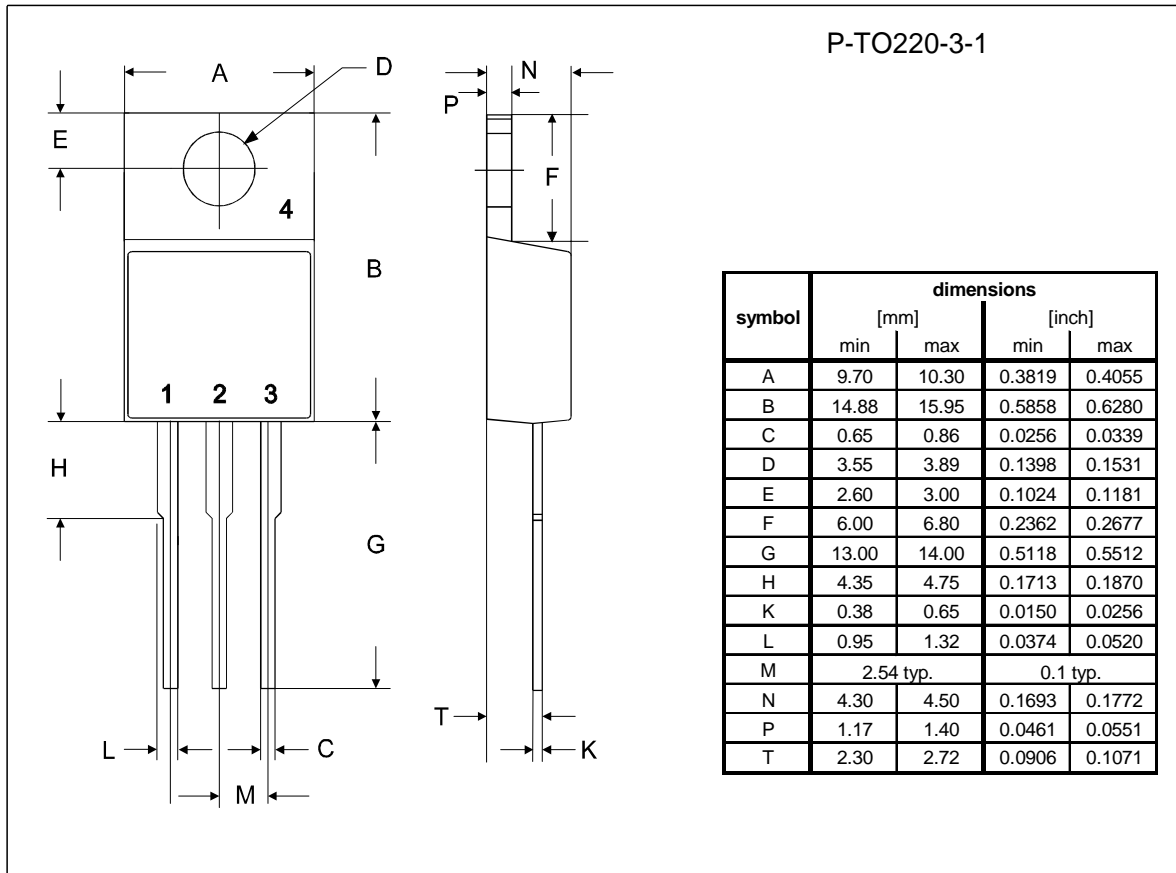

Published by
Infineon Technologies AG,
Bereichs Kommunikation
St.-Martin-Strasse 53,
D-81541 München
© Infineon Technologies AG 1999
All Rights Reserved.

Attention please!

The information herein is given to describe certain components and shall not be considered as warranted characteristics.

Terms of delivery and rights to technical change reserved.

We hereby disclaim any and all warranties, including but not limited to warranties of non-infringement, regarding circuits, descriptions and charts stated herein.

Infineon Technologies is an approved CECC manufacturer.

Information

For further information on technology, delivery terms and conditions and prices please contact your nearest Infineon Technologies Office in Germany or our Infineon Technologies Representatives worldwide (see address list).

Warnings

Due to technical requirements components may contain dangerous substances.

For information on the types in question please contact your nearest Infineon Technologies Office.

Infineon Technologies Components may only be used in life-support devices or systems with the express written approval of Infineon Technologies, if a failure of such components can reasonably be expected to cause the failure of that life-support device or system, or to affect the safety or effectiveness of that device or system. Life support devices or systems are intended to be implanted in the human body, or to support and/or maintain and sustain and/or protect human life. If they fail, it is reasonable to assume that the health of the user or other persons may be endangered.