



# SP6013A

## Synchronous Rectifier Driver

### DESCRIPTION

The fundamental of SP6013A synchronous rectifier (SR) driver IC is based on our U.S. patented methods that utilize the principle of “prediction” logic circuit. The IC deliberates previous cycle timing to control the SR in present cycle by “predictive” algorithm that makes adjustments to the turn-off time, in order to achieve maximum efficiency and avoid cross-conduction at the same time. It also maintains the MOSFET’s body diode conduction at minimum level. The SP6013A is capable to adapt in almost all existing flyback converters with few adjustments considered necessary.

### FEATURES

- Offers efficiency improvement over Schottky Diode (depends on drive configuration of the SR).
- Drives all logic level Power MOSFET.
- Prediction gate timing control.
- Minimum MOSFET body diode conduction.
- Operating frequency up to 650 KHz.
- Synchronize to transformer secondary voltage waveform.

### APPLICATIONS

- Servers & workstations
- Storage area network power supplies
- Telecommunication converters
- Embedded systems
- Industrial & commercial systems using high current processors

### PIN CONFIGURATION (SOP-8)

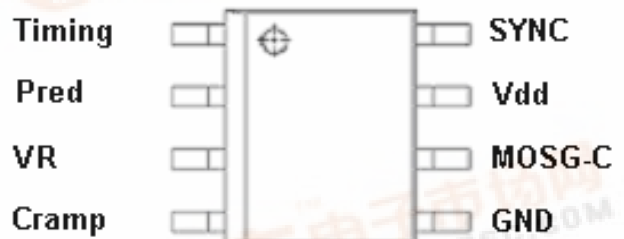

### PART MARKING



A : Lot Code  
B : Date Code



# SP6013A Synchronous Rectifier Driver

## TYPICAL APPLICATION CIRCUIT

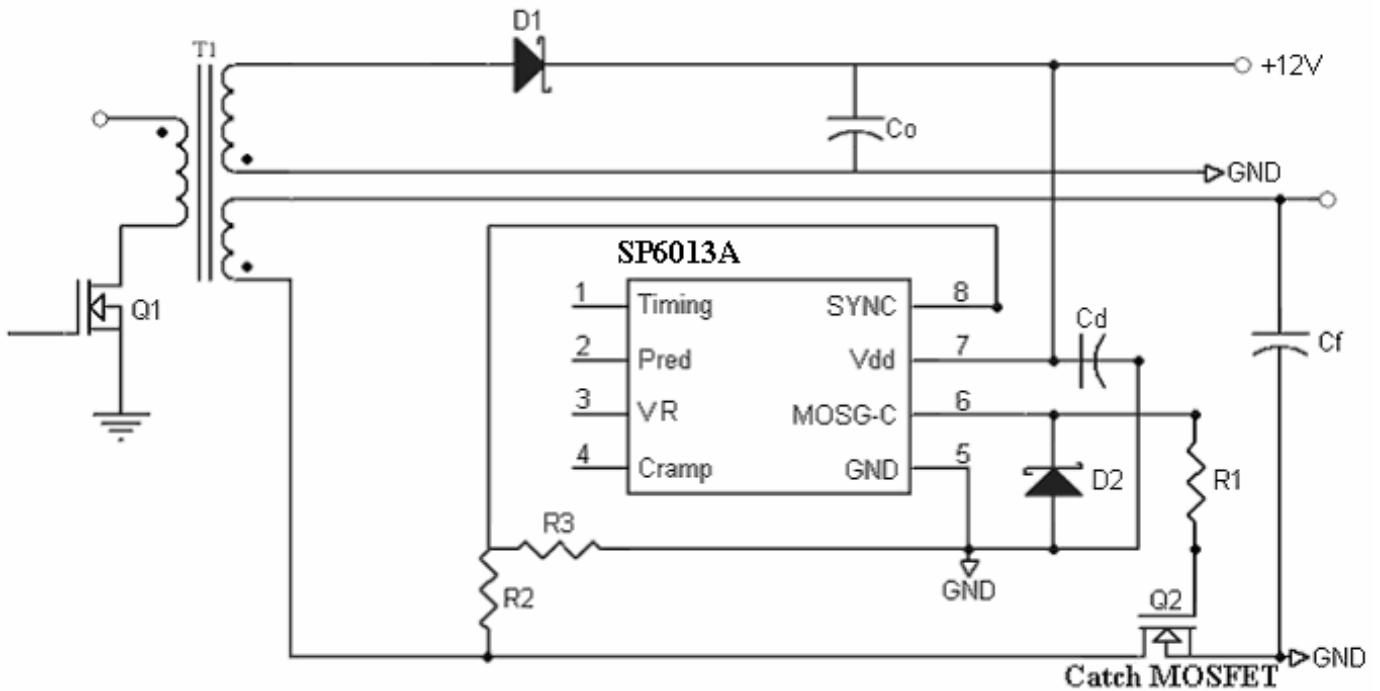

## PIN DESCRIPTION

| Pin | Symbol | Description   |
|-----|--------|---|
| 1   | Timing | Discontinuous current filter timing adjustment resistor connection. |
| 2   | Pred   | Capacitor to store previous cycle timing for Catch MOSFET           |
| 3   | VR     | Voltage Regulator   |
| 4   | Cramp  | Ramp capacitor adjustment to extend MOSFET's gate timing.           |
| 5   | GND    | Ground connection.  |
| 6   | MOSG-C | Catch MOSFET gate drive.  |
| 7   | Vdd    | DC supply voltage.  |
| 8   | SYNC   | Synchronized signal from transformer's output.                      |



# SP6013A

## Synchronous Rectifier Driver

### BLOCK DIAGRAM

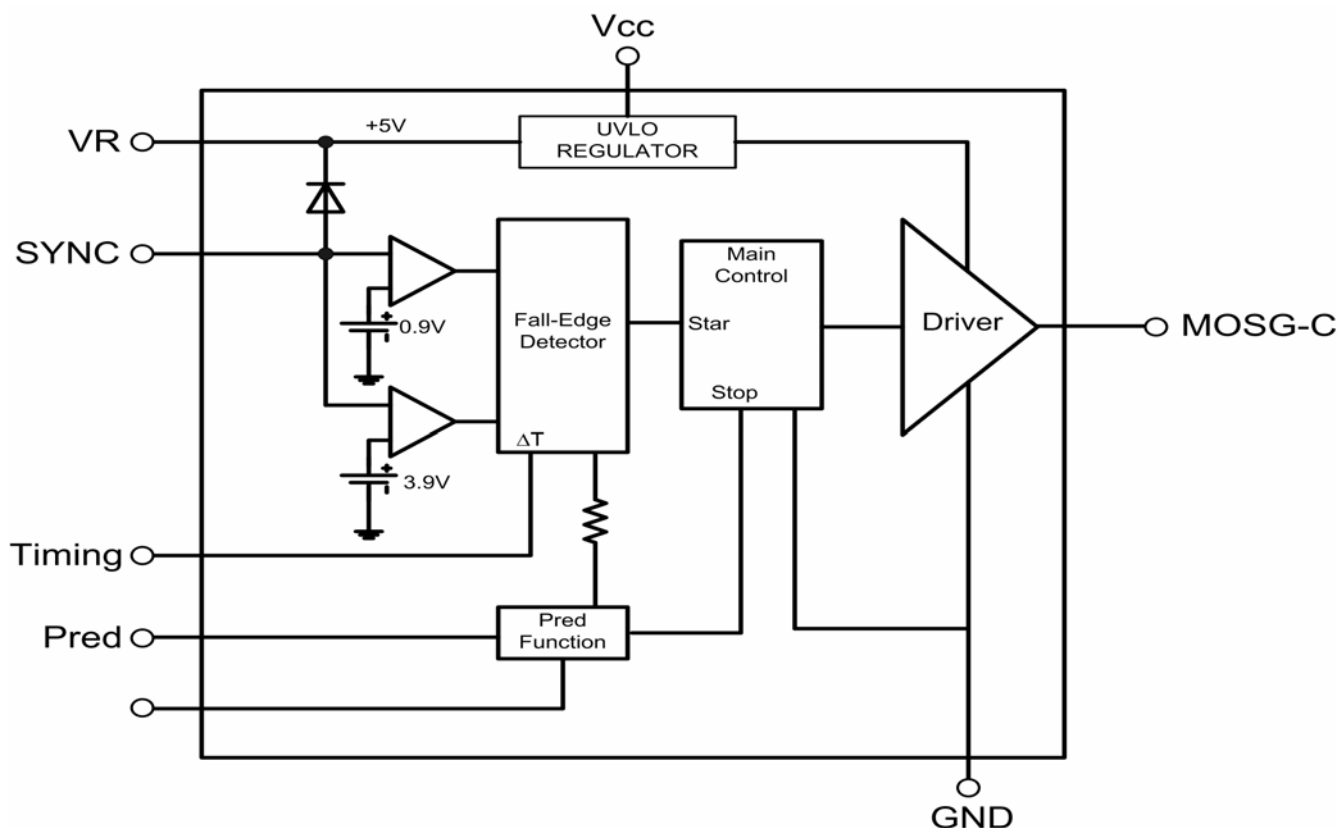

### ORDERING INFORMATION

| Part Number | Package | Part Marking |
|-------------|---------|--------------|
| SP6013AS8RG | SOP-8   | SP6013AI     |
| SP6013AS8TG | SOP-8   | SP6013AI     |

※ SP6013AS8RG : 7" Tape Reel ; Pb – Free

※ SP6013AS8TG : Tube ; Pb – Free

### ABSOLUTE MAXIMUM RATINGS (TA=25°C, unless otherwise specified.)

The following ratings designate persistent limits beyond which damage to the device may occur.

| Symbol            | Parameter                                    | Value      | Unit |
|-------------------|--|------------|------|
| V <sub>dd</sub>   | DC Supply Voltage                            | 17         | V    |
| SYNC              | SYNC Voltage                                 | 7          | V    |
| I <sub>OUT</sub>  | Peak Source Current (Pulsed)                 | 3          | A    |
|                   | Peak Sink Current (Pulsed)                   | 3          | A    |
| P <sub>D</sub>    | Power Dissipation @ T <sub>A</sub> =85°C (*) | 0.25       | W    |
| T <sub>J</sub>    | Operating Junction Temperature Range         | -40 to 125 | °C   |
| T <sub>STG</sub>  | Storage Temperature Range                    | -40 to 150 | °C   |
| T <sub>LEAD</sub> | Lead Soldering Temperature for 5 sec.        | 260        | °C   |



# SP6013A

## Synchronous Rectifier Driver

### THERMAL RESISTANCE

| Symbol          | Parameter                              | Value | Unit          |
|-----------------|--|-------|---------------|
| $R_{\theta JC}$ | Thermal Resistance Junction – Case (*) | 45    | $^{\circ}C/W$ |

(\*) The power dissipation and thermal resistance are evaluated under copper board mounted with free air conditions.

### ELECTRICAL CHARACTERISTICS

( $T_A=25^{\circ}C$ ,  $V_{dd}=12V$ , Freq. =300 KHz, Duty Cycle=50%, unless otherwise specified.)

| Symbol                             | Parameter              | Conditions              | Min. | Typ. | Max. | Unit |
|------------------------------------|------------------------|-------------------------|------|------|------|------|
| <b>SUPPLY INPUT</b>                |                        |                         |      |      |      |      |
| IDD                                | Supply current         | No load                 |      | 10   | 16   | mA   |
|                                    |                        | $V_{SYNC}=0V$ , No load |      | 7.5  | 10   | mA   |
| Vonh                               | Vdd turn on threshold  |                         |      | 9.5  | 10   | V    |
| Voffh                              | Vdd turn off threshold |                         | 8    | 8.5  |      | V    |
| <b>SYNC REFERENCE (SYNC)</b>       |                        |                         |      |      |      |      |
| Vshth                              | SYNC high threshold    |                         | 3.9  | 5.0  |      | V    |
| Vslth                              | SYNC low threshold     |                         |      | 0.9  | 1.2  | V    |
| <b>MOSFET GATE DRIVER (MOSG-C)</b> |                        |                         |      |      |      |      |
| Voh                                | Output high voltage    | $I_o = -200mA$          | 11.5 | 11.8 |      | V    |
| Vol                                | Output low voltage     | $I_o = 200mA$           |      | 0.1  | 0.2  | V    |
| Td                                 | Propagation delay      | No load                 | 15   | 35   |      | ns   |
| Tpred                              |                        | No load                 |      | 120  |      | ns   |
| Tr                                 | Rise time              | Load = 1nF (*)          |      | 10   | 25   | ns   |
| Tf                                 | Fall time              | Load = 1nF (*)          |      | 10   | 25   | ns   |

(\*)  $T_r$  &  $T_f$  are measured among 10% and 90% of starting and final voltage.

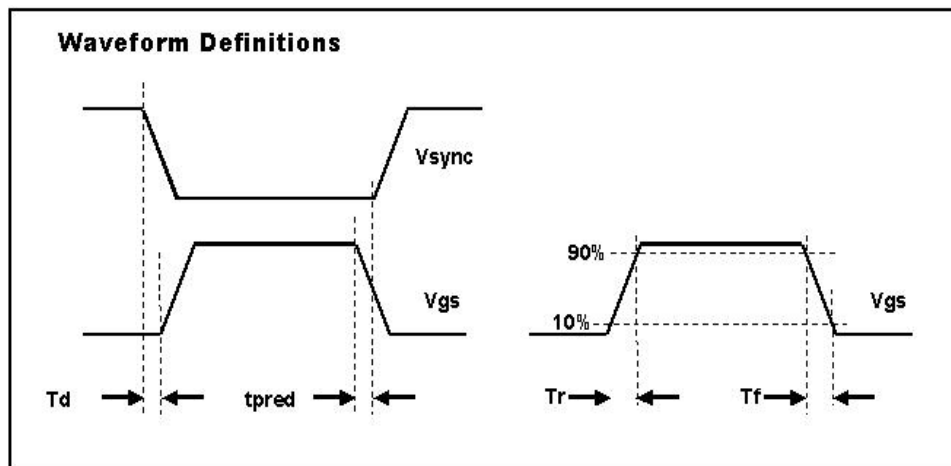



# SP6013A Synchronous Rectifier Driver

PERFORMANCE CHARACTERISTICS ( $T_A=25^\circ\text{C}$ , unless otherwise specified.)

Figure 1 : Supply Current vs Supply Voltage

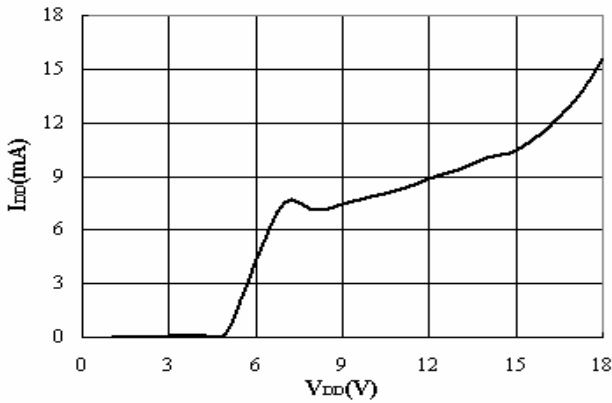

Figure 2 : Supply Current vs Freq. @ No Load

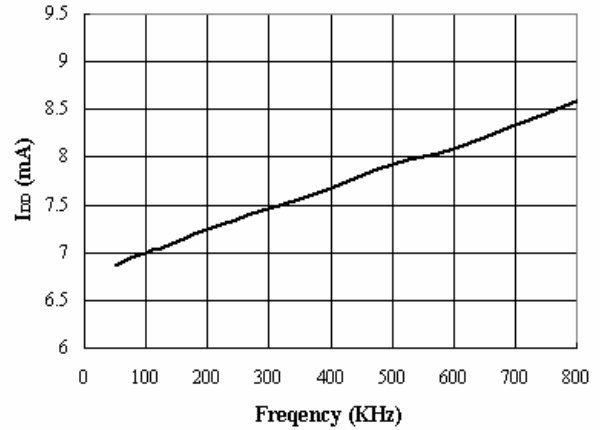

Figure 3 :  $T_{pred}$  vs  $C_{pred}$  @ Freq = 70 KHz ;  $V_{DD}=10V$

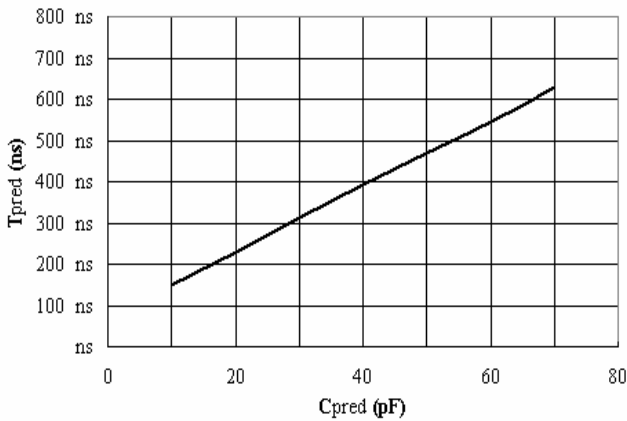

Figure 4 : Output Rise Time vs Load Capacitor

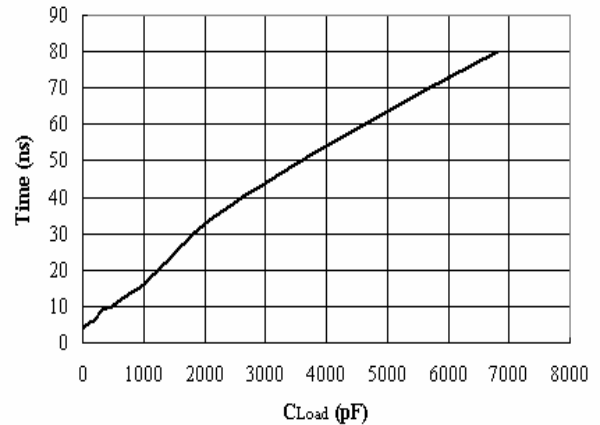

Figure 5 : Output Fall Time vs Load Capacitor

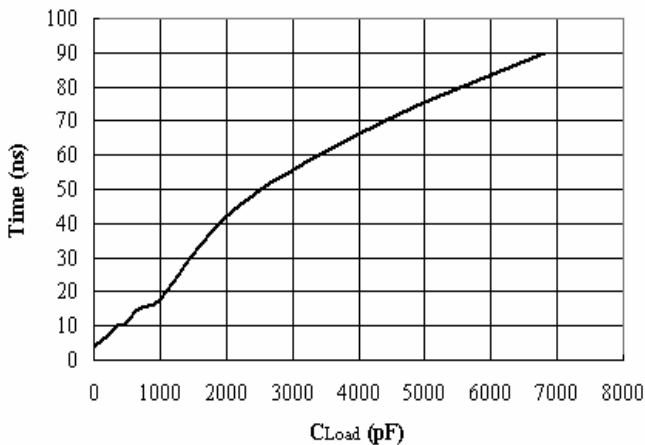
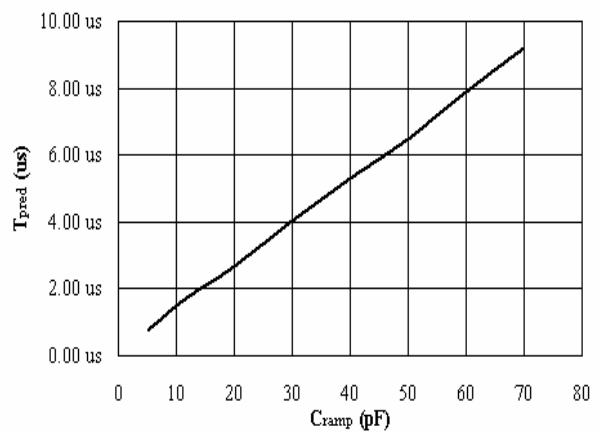

Figure 6 :  $T_{pred}$  vs  $C_{ramp}$  @ Freq = 20 KHz



\*Fig. 1 : No Load ; No SYNC

\*Fig. 4-5 : Frequency = 65 kHz.



# SP6013A

## Synchronous Rectifier Driver

### SOP-8 PACKAGE OUTLINE

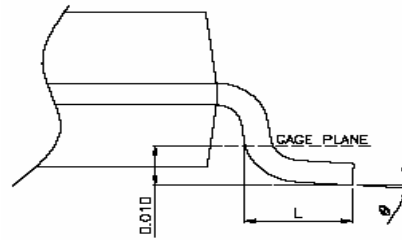
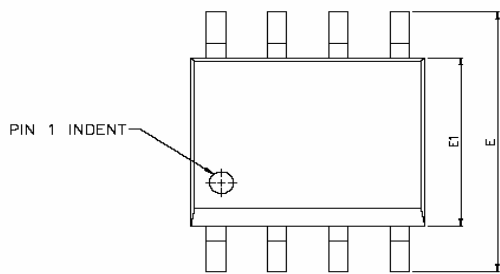

DETAIL A

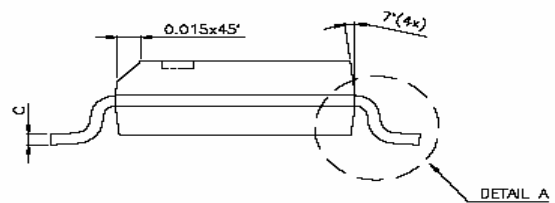
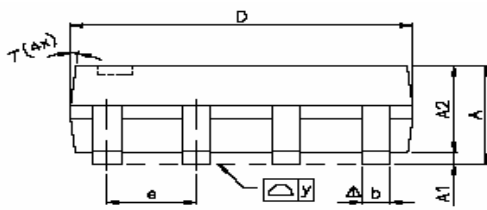

| SYMBOLS       | DIMENSIONS IN MILLIMETERS |      |       | DIMENSIONS IN INCHES |       |        |
|---------------|---------------------------|------|-------|----------------------|-------|--------|
|               | MIN                       | NOM  | MAX   | MIN                  | NOM   | MAX    |
| A             | 1.47                      | 1.60 | 1.73  | 0.058                | 0.063 | 0.068  |
| A1            | 0.10                      | —    | 0.25  | 0.004                | —     | 0.010  |
| A2            | —                         | 1.45 | —     | —                    | 0.057 | —      |
| b             | 0.33                      | 0.41 | 0.51  | 0.013                | 0.016 | 0.020  |
| C             | 0.19                      | 0.20 | 0.25  | 0.0075               | 0.008 | 0.0098 |
| D             | 4.80                      | 4.85 | 4.95  | 0.189                | 0.191 | 0.195  |
| E             | 5.80                      | 6.00 | 6.20  | 0.228                | 0.236 | 0.244  |
| E1            | 3.80                      | 3.90 | 4.00  | 0.150                | 0.154 | 0.157  |
| e             | —                         | 1.27 | —     | —                    | 0.050 | —      |
| L             | 0.38                      | 0.71 | 1.27  | 0.015                | 0.028 | 0.050  |
| $\Delta$ y    | —                         | —    | 0.076 | —                    | —     | 0.003  |
| $\varnothing$ | 0°                        | —    | 8°    | 0°                   | —     | 8°     |



# SP6013A

## Synchronous Rectifier Driver

---

Information provided is alleged to be exact and consistent. SYNC Power Corporation presumes no responsibility for the penalties of use of such information or for any violation of patents or other rights of third parties, which may result from its use. No license is granted by allegation or otherwise under any patent or patent rights of SYNC Power Corporation. Conditions mentioned in this publication are subject to change without notice. This publication surpasses and replaces all information previously supplied. SYNC Power Corporation products are not authorized for use as critical components in life support devices or systems without express written approval of SYNC Power Corporation.

©The SYNC Power logo is a registered trademark of SYNC Power Corporation  
©2004 SYNC Power Corporation – Printed in Taiwan – All Rights Reserved  
SYNC Power Corporation  
9F-5, No.3-2, Park Street  
NanKang District (NKSP), Taipei, Taiwan, 115, R.O.C  
Phone: 886-2-2655-8178  
Fax: 886-2-2655-8468  
<http://www.synepower.com>