

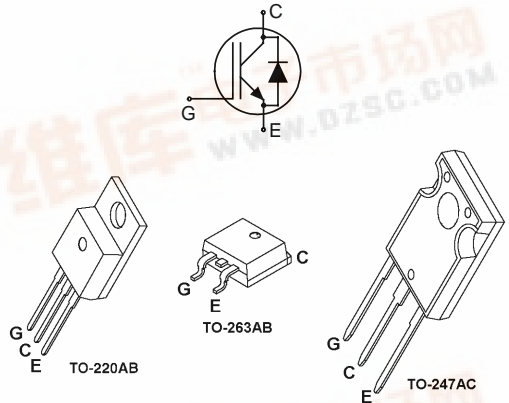

SKP10N60 SKB10N60, SKW10N60

Fast S-IGBT in NPT-technology with soft, fast recovery anti-parallel EmCon diode

- 75% lower E_{off} compared to previous generation combined with low conduction losses
- Short circuit withstand time – 10 μ s
- Designed for:
 - Motor controls
 - Inverter
- NPT-Technology for 600V applications offers:
 - very tight parameter distribution
 - high ruggedness, temperature stable behaviour
 - parallel switching capability
- Very soft, fast recovery anti-parallel EmCon diode



Type	V_{CE}	I_C	$V_{CE(sat)}$	T_j	Package	Ordering Code
SKP10N60	600V	10A	2.2V	150°C	TO-220AB	Q67040-S4217
SKB10N60					TO-263AB	Q67040-S4218
SKW10N60					TO-247AC	Q67040-S4241

Maximum Ratings

Parameter	Symbol	Value	Unit
Collector-emitter voltage	V_{CE}	600	V
DC collector current	I_C	21	A
$T_C = 25^\circ\text{C}$		10.9	
$T_C = 100^\circ\text{C}$			
Pulsed collector current, t_p limited by T_{jmax}	I_{Cpuls}	42	
Turn off safe operating area	-	42	
$V_{CE} \leq 600\text{V}, T_j \leq 150^\circ\text{C}$			
Diode forward current	I_F	21	
$T_C = 25^\circ\text{C}$		10	
$T_C = 100^\circ\text{C}$			
Diode pulsed current, t_p limited by T_{jmax}	I_{Fpuls}	42	
Gate-emitter voltage	V_{GE}	± 20	V
Short circuit withstand time ¹⁾	t_{SC}	10	μ s
$V_{GE} = 15\text{V}, V_{CC} \leq 600\text{V}, T_j \leq 150^\circ\text{C}$			
Power dissipation	P_{tot}	104	W
$T_C = 25^\circ\text{C}$			
Operating junction and storage temperature	T_j, T_{stg}	-55...+150	°C





SKP10N60

SKB10N60, SKW10N60

Thermal Resistance

Parameter	Symbol	Conditions	Max. Value	Unit
Characteristic				
IGBT thermal resistance, junction – case	R_{thJC}		1.2	K/W
Diode thermal resistance, junction – case	R_{thJCD}		2.4	
Thermal resistance, junction – ambient	R_{thJA}	TO-220AB TO-247AC	62 40	
SMD version, device on PCB ¹⁾	R_{thJA}	TO-263AB	40	

Electrical Characteristic, at $T_j = 25^\circ\text{C}$, unless otherwise specified

Parameter	Symbol	Conditions	Value			Unit
			min.	Typ.	max.	
Static Characteristic						
Collector-emitter breakdown voltage	$V_{(BR)CES}$	$V_{GE}=0V, I_C=500\mu A$	600	-	-	V
Collector-emitter saturation voltage	$V_{CE(sat)}$	$V_{GE} = 15V, I_C=10A$ $T_j=25^\circ\text{C}$ $T_j=150^\circ\text{C}$	1.7 -	2 2.2	2.4 2.7	
Diode forward voltage	V_F	$V_{GE}=0V, I_F=10A$ $T_j=25^\circ\text{C}$ $T_j=150^\circ\text{C}$	1.2 -	1.4 1.25	1.8 1.65	
Gate-emitter threshold voltage	$V_{GE(th)}$	$I_C=300\mu A, V_{CE}=V_{GE}$	3	4	5	
Zero gate voltage collector current	I_{CES}	$V_{CE}=600V, V_{GE}=0V$ $T_j=25^\circ\text{C}$ $T_j=150^\circ\text{C}$	- -	- -	40 1500	μA
Gate-emitter leakage current	I_{GES}	$V_{CE}=0V, V_{GE}=20V$	-	-	100	
Transconductance	g_{fs}	$V_{CE}=20V, I_C=10A$	-	6.7	-	S
Dynamic Characteristic						
Input capacitance	C_{iss}	$V_{CE}=25V,$ $V_{GE}=0V,$ $f=1\text{MHz}$	-	580	696	μF
Output capacitance	C_{oss}		-	70	84	
Reverse transfer capacitance	C_{riss}		-	50	60	
Gate charge	Q_{Gate}	$V_{CC}=480V, I_C=10A$ $V_{GE}=15V$	-	64	83	nC
Internal emitter inductance measured 5mm (0.197 in.) from case	L_E	TO-220AB TO-247AC	- -	7 13	- -	nH
Short circuit collector current ²⁾	$I_{C(SC)}$	$V_{GE}=15V, t_{SC}\leq 10\mu s$ $V_{CC}\leq 600V,$ $T_j\leq 150^\circ\text{C}$	-	100	-	A

¹⁾ Device on 50mm*50mm*1.5mm epoxy PCB FR4 with 6cm² (one layer, 70 μ m thick) copper area for collector connection. PCB is vertical without blown air.

²⁾ Allowed number of short circuits: <1000; time between short circuits: >1s.

Switching Characteristic, Inductive Load, at $T_j=25^\circ\text{C}$

Parameter	Symbol	Conditions	Value			Unit
			min.	typ.	max.	
IGBT Characteristic						
Turn-on delay time	$t_{d(on)}$	$T_j=25^\circ\text{C}$, $V_{CC}=400\text{V}$, $I_C=10\text{A}$, $V_{GE}=0/15\text{V}$, $R_G=25\Omega$, Energy losses include "tail" and diode reverse recovery.	-	29	35	ns
Rise time	t_r		-	21	25	
Turn-off delay time	$t_{d(off)}$		-	233	280	
Fall time	t_f		-	49	59	
Turn-on energy	E_{on}		-	0.20	0.230	mJ
Turn-off energy	E_{off}		-	0.17	0.221	
Total switching energy	E_{ts}		-	0.370	0.451	
Anti-Parallel Diode Characteristic						
Diode reverse recovery time	t_{rr}	$T_j=25^\circ\text{C}$, $V_R=200\text{V}$, $I_F=10\text{A}$, $di_F/dt=200\text{A}/\mu\text{s}$	-	220	-	ns
	t_S		-	20	-	
	t_F		-	200	-	
Diode reverse recovery charge	Q_{rr}		-	310	-	nC
Diode peak reverse recovery current	I_{rrm}		-	4.5	-	A
Diode peak rate of fall of reverse recovery current during t_b	di_{rr}/dt		-	180	-	A/ μs

Switching Characteristic, Inductive Load, at $T_j=150^\circ\text{C}$

Parameter	Symbol	Conditions	Value			Unit
			min.	typ.	max.	
IGBT Characteristic						
Turn-on delay time	$t_{d(on)}$	$T_j=150^\circ\text{C}$ $V_{CC}=400\text{V}$, $I_C=10\text{A}$, $V_{GE}=0/15\text{V}$, $R_G=25\Omega$ Energy losses include "tail" and diode reverse recovery.	-	29	35	ns
Rise time	t_r		-	21	25	
Turn-off delay time	$t_{d(off)}$		-	266	319	
Fall time	t_f		-	63	76	
Turn-on energy	E_{on}		-	0.297	0.342	mJ
Turn-off energy	E_{off}		-	0.28	0.364	
Total switching energy	E_{ts}		-	0.577	0.706	
Anti-Parallel Diode Characteristic						
Diode reverse recovery time	t_{rr}	$T_j=150^\circ\text{C}$ $V_R=200\text{V}$, $I_F=10\text{A}$, $di_F/dt=200\text{A}/\mu\text{s}$	-	350	-	ns
	t_S		-	36	-	
	t_F		-	314	-	
Diode reverse recovery charge	Q_{rr}		-	690	-	nC
Diode peak reverse recovery current	I_{rrm}		-	6.3	-	A
Diode peak rate of fall of reverse recovery current during t_b	di_{rr}/dt		-	200	-	A/ μs

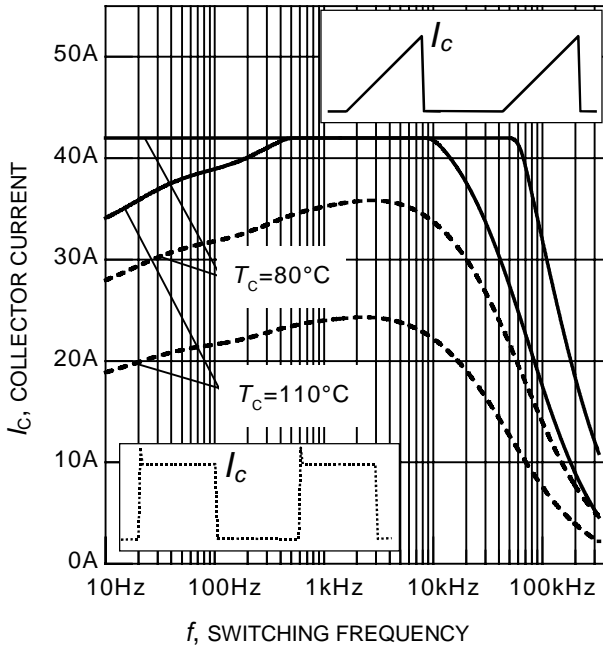

Figure 1. Collector current as a function of switching frequency
 ($T_j \leq 150^\circ\text{C}$, $D = 0.5$, $V_{CE} = 400\text{V}$,
 $V_{GE} = 0/+15\text{V}$, $R_G = 25\Omega$)

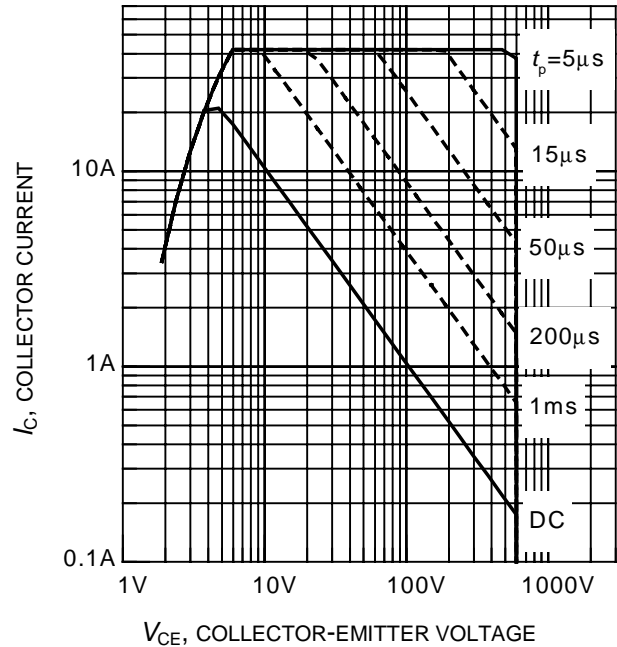

Figure 2. Safe operating area
 ($D = 0$, $T_C = 25^\circ\text{C}$, $T_j \leq 150^\circ\text{C}$)

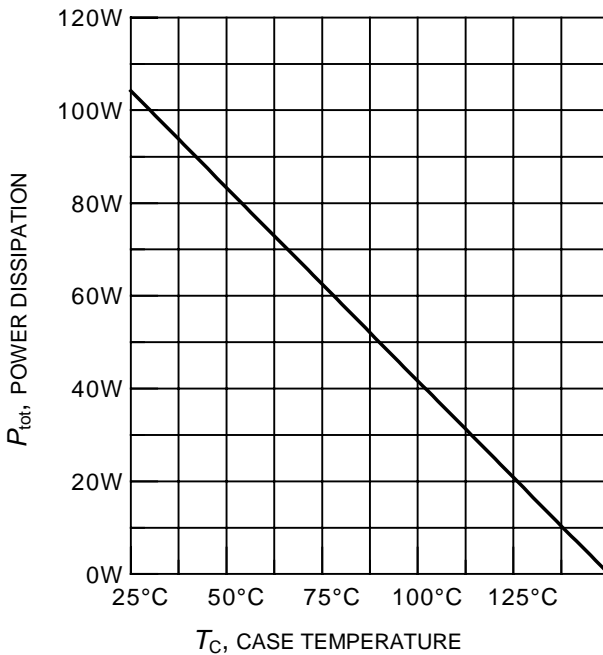

Figure 3. Power dissipation as a function of case temperature
 ($T_j \leq 150^\circ\text{C}$)

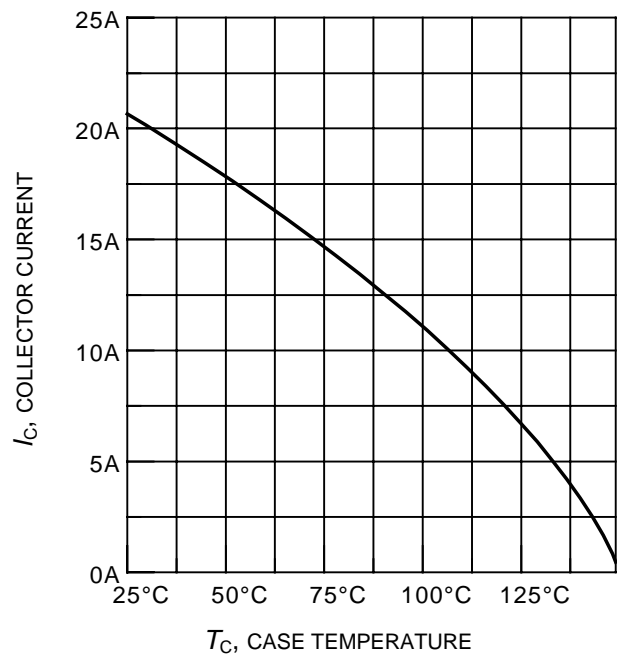

Figure 4. Collector current as a function of case temperature
 ($V_{GE} \leq 15\text{V}$, $T_j \leq 150^\circ\text{C}$)

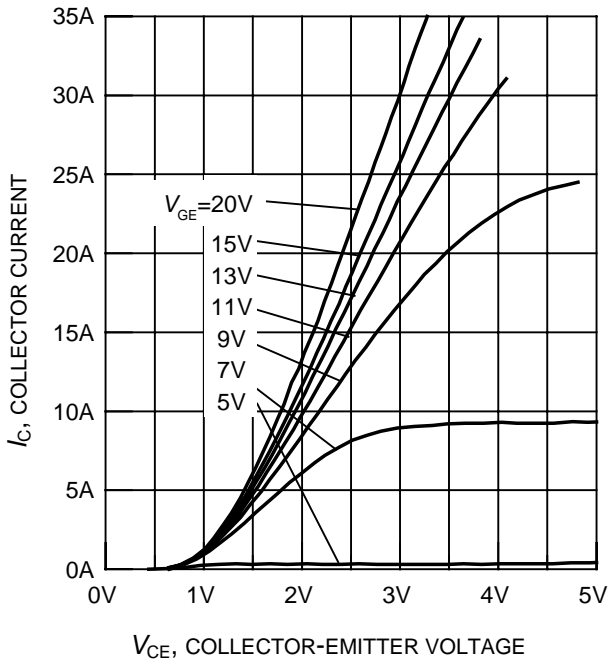

Figure 5. Typical output characteristics
($T_j = 25^\circ\text{C}$)

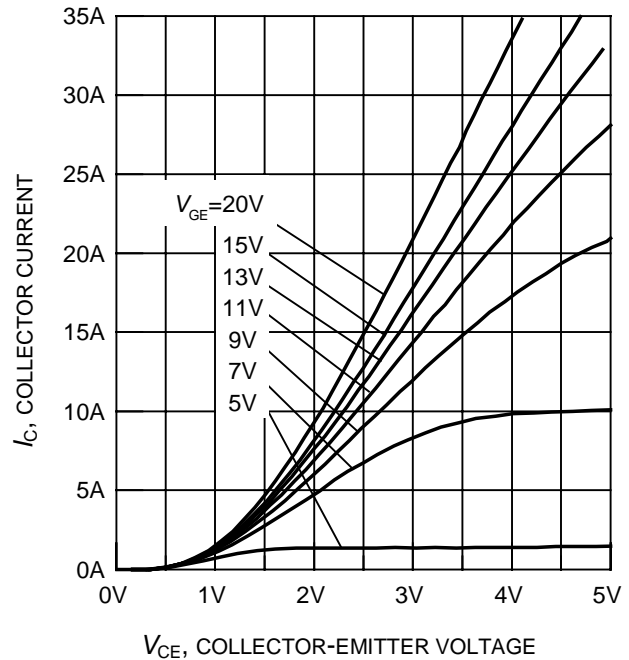

Figure 6. Typical output characteristics
($T_j = 150^\circ\text{C}$)

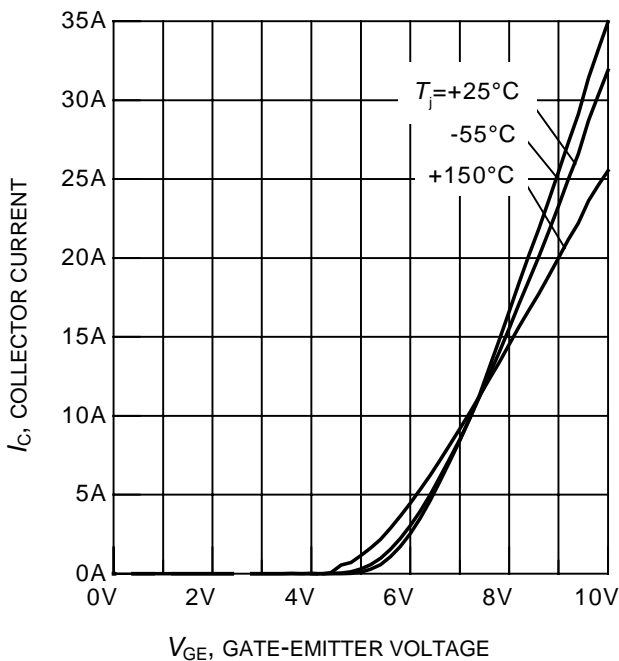

Figure 7. Typical transfer characteristics
($V_{CE} = 10\text{V}$)

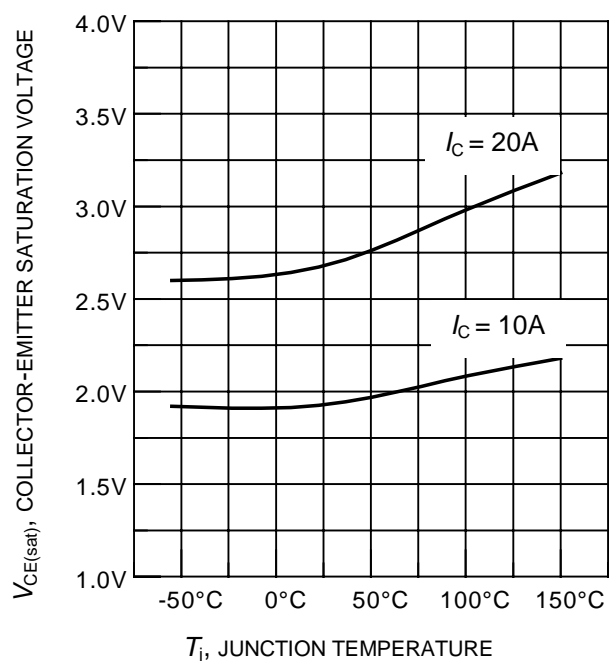

Figure 8. Typical collector-emitter saturation voltage as a function of junction temperature
($V_{GE} = 15\text{V}$)

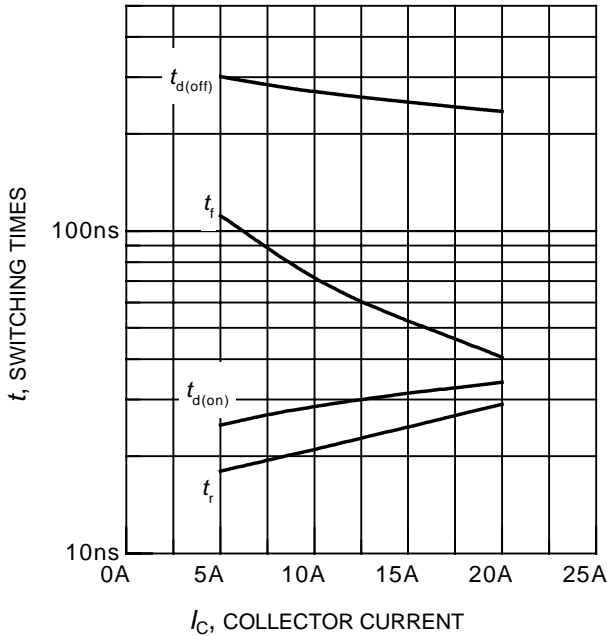

Figure 9. Typical switching times as a function of collector current
(inductive load, $T_j = 150^\circ\text{C}$, $V_{CE} = 400\text{V}$, $V_{GE} = 0/+15\text{V}$, $R_G = 25\Omega$)

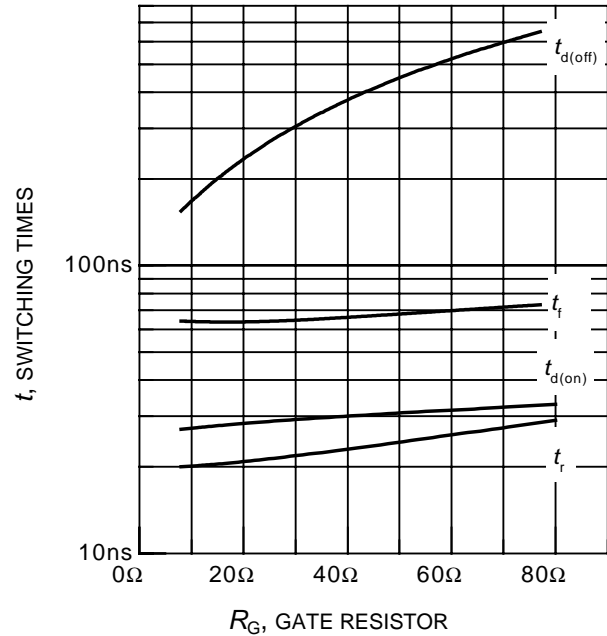

Figure 10. Typical switching times as a function of gate resistor
(inductive load, $T_j = 150^\circ\text{C}$, $V_{CE} = 400\text{V}$, $V_{GE} = 0/+15\text{V}$, $I_C = 10\text{A}$)

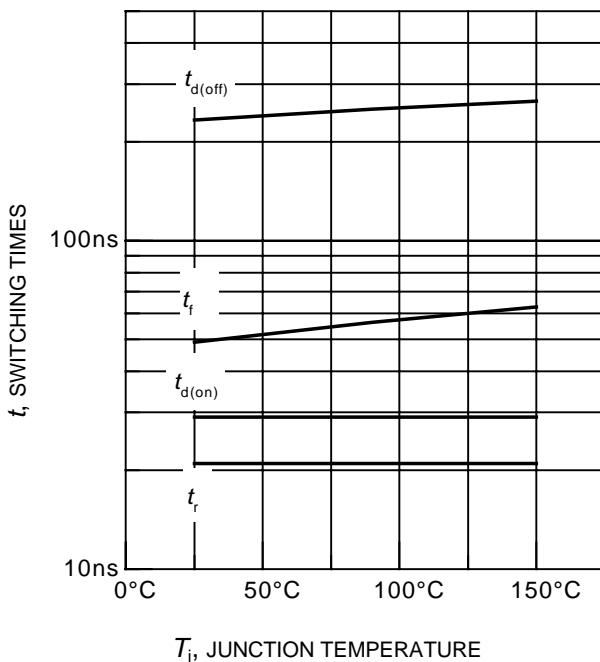

Figure 11. Typical switching times as a function of junction temperature
(inductive load, $V_{CE} = 400\text{V}$, $V_{GE} = 0/+15\text{V}$, $I_C = 10\text{A}$, $R_G = 25\Omega$)

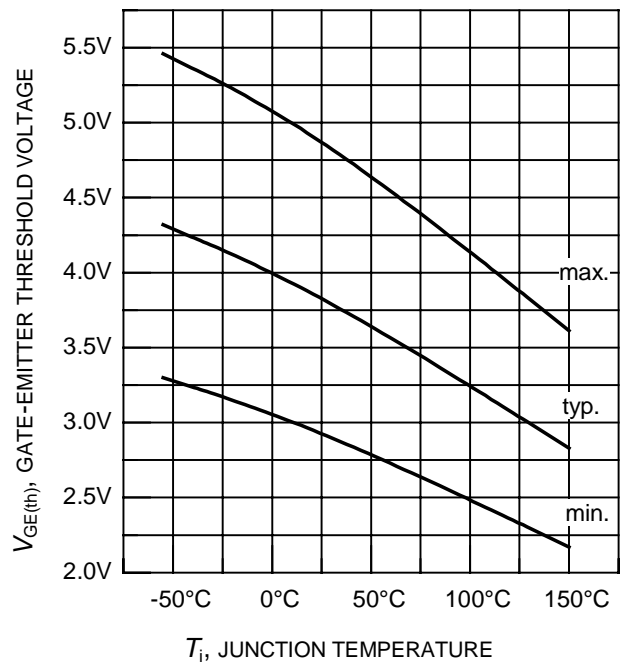

Figure 12. Gate-emitter threshold voltage as a function of junction temperature
($I_C = 0.3\text{mA}$)

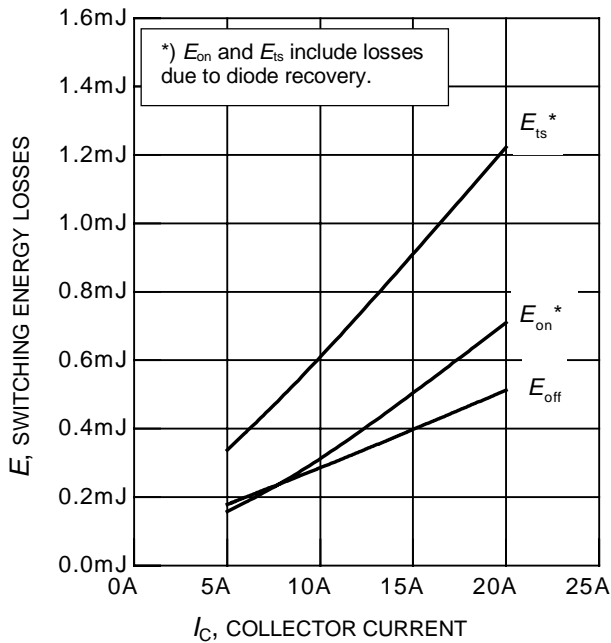

Figure 13. Typical switching energy losses as a function of collector current
(inductive load, $T_j = 150^\circ\text{C}$, $V_{CE} = 400\text{V}$, $V_{GE} = 0/+15\text{V}$, $R_G = 25\Omega$)

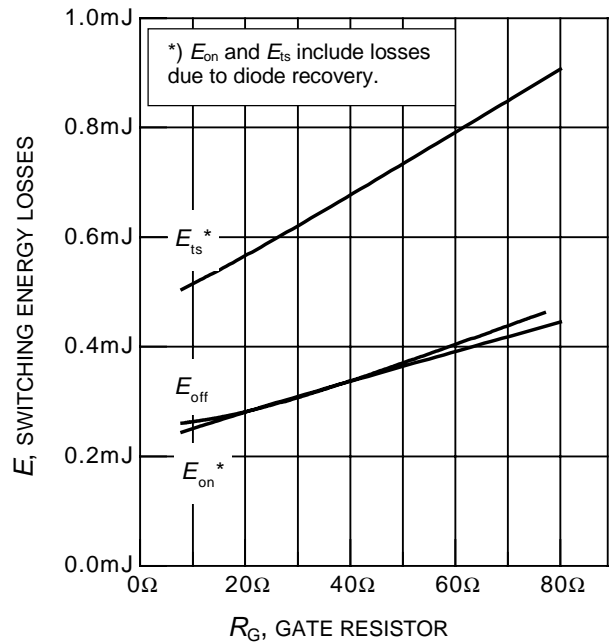

Figure 14. Typical switching energy losses as a function of gate resistor
(inductive load, $T_j = 150^\circ\text{C}$, $V_{CE} = 400\text{V}$, $V_{GE} = 0/+15\text{V}$, $I_C = 10\text{A}$)

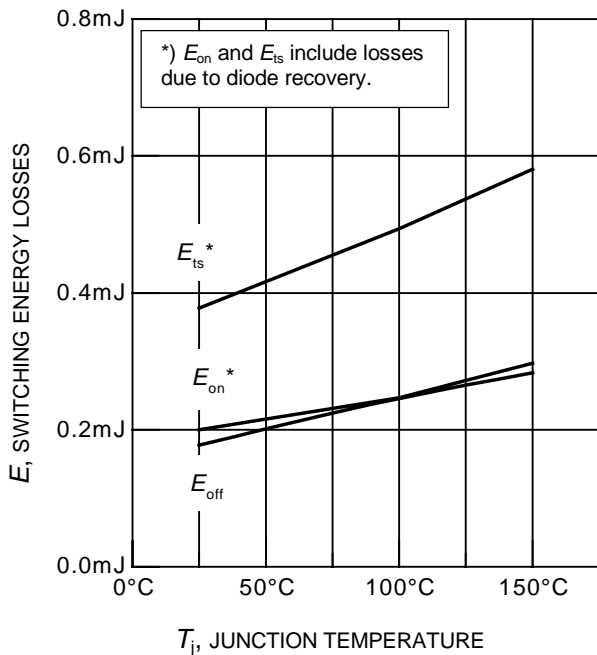

Figure 15. Typical switching energy losses as a function of junction temperature
(inductive load, $V_{CE} = 400\text{V}$, $V_{GE} = 0/+15\text{V}$, $I_C = 10\text{A}$, $R_G = 25\Omega$)

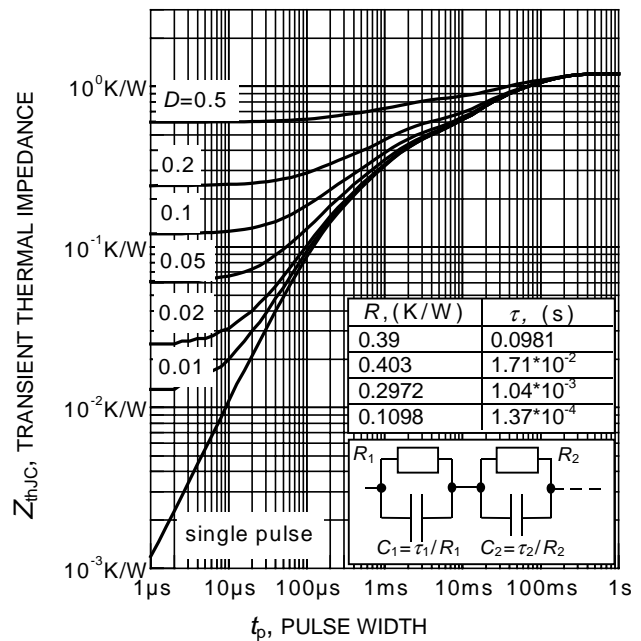

Figure 16. IGBT transient thermal impedance as a function of pulse width
($D = t_p / T$)

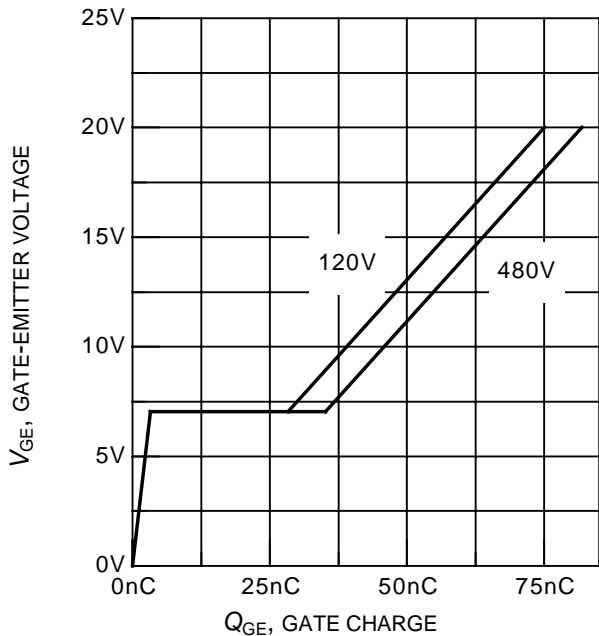

Figure 17. Typical gate charge
($I_C = 10A$)

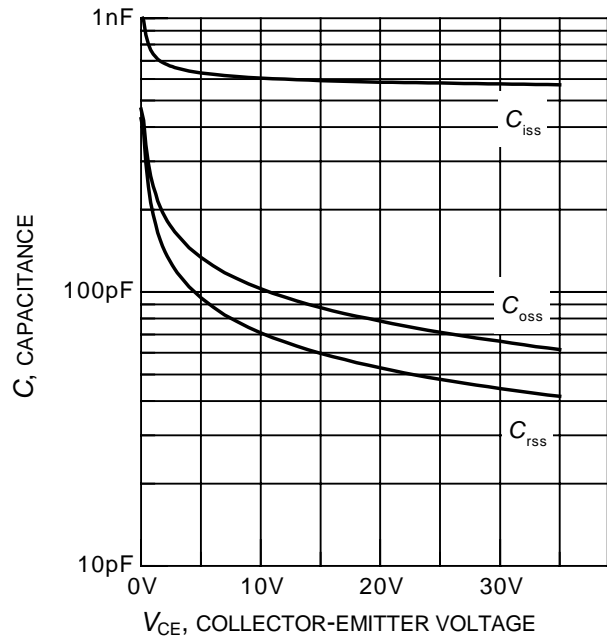

Figure 18. Typical capacitance as a function of collector-emitter voltage
($V_{GE} = 0V, f = 1MHz$)

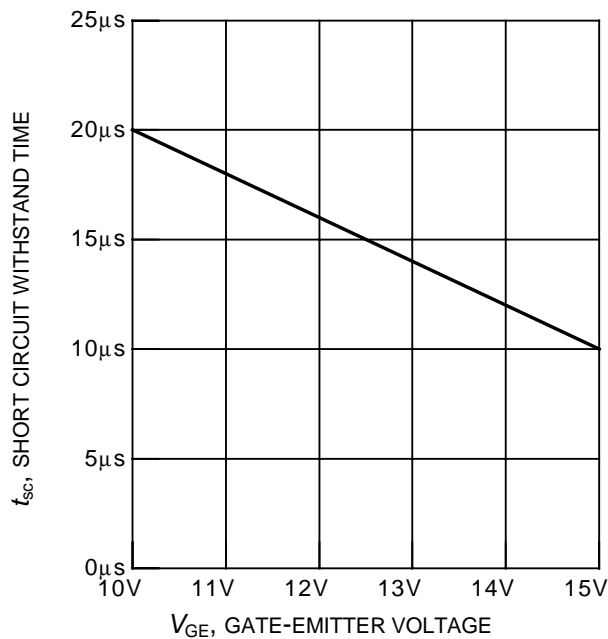

Figure 19. Short circuit withstand time as a function of gate-emitter voltage
($V_{CE} = 600V, \text{start at } T_j = 25^\circ C$)

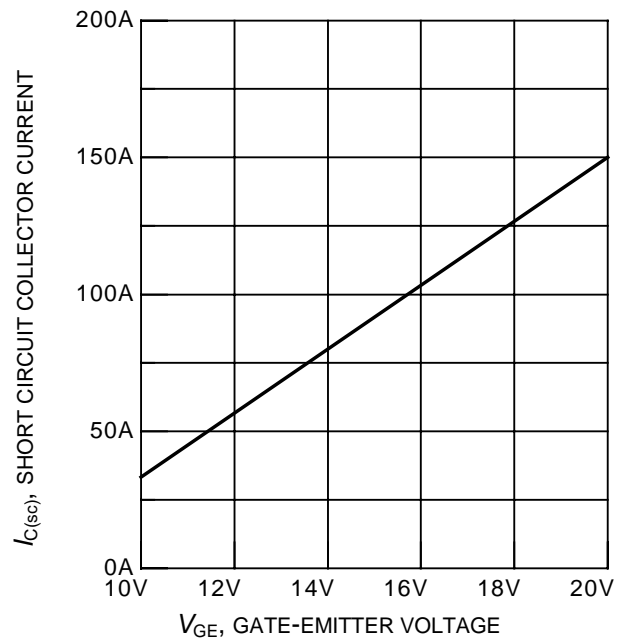
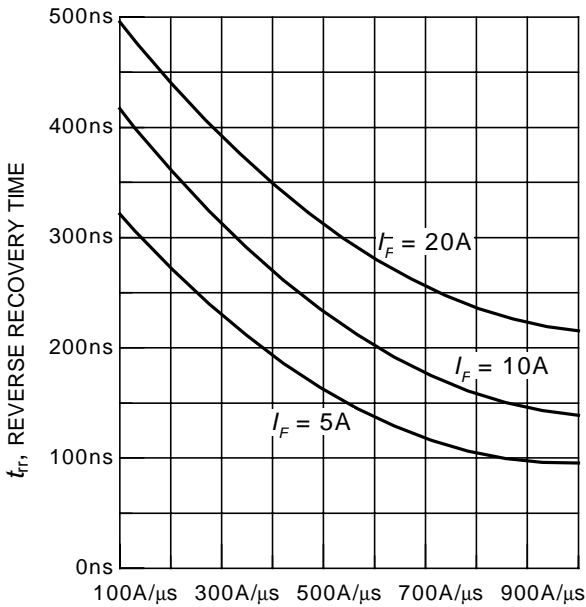
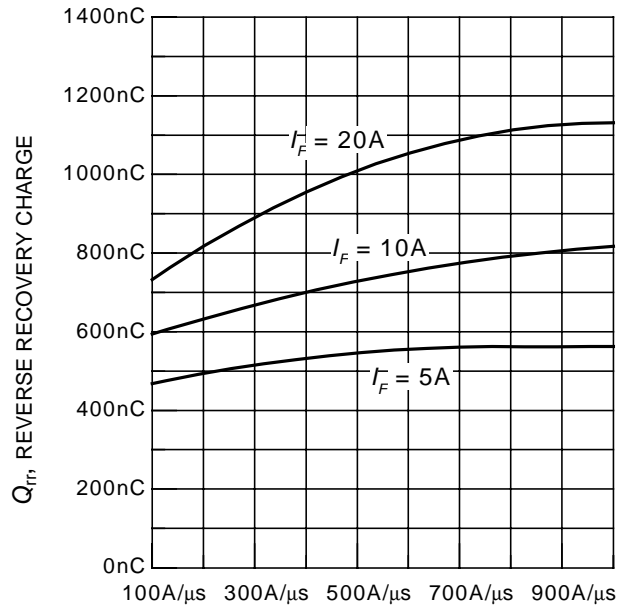

Figure 20. Typical short circuit collector current as a function of gate-emitter voltage
($V_{CE} \leq 600V, T_j = 150^\circ C$)



di_F/dt , DIODE CURRENT SLOPE
Figure 21. Typical reverse recovery time as a function of diode current slope
 ($V_R = 200V$, $T_j = 125^\circ C$)



di_F/dt , DIODE CURRENT SLOPE
Figure 22. Typical reverse recovery charge as a function of diode current slope
 ($V_R = 200V$, $T_j = 125^\circ C$)

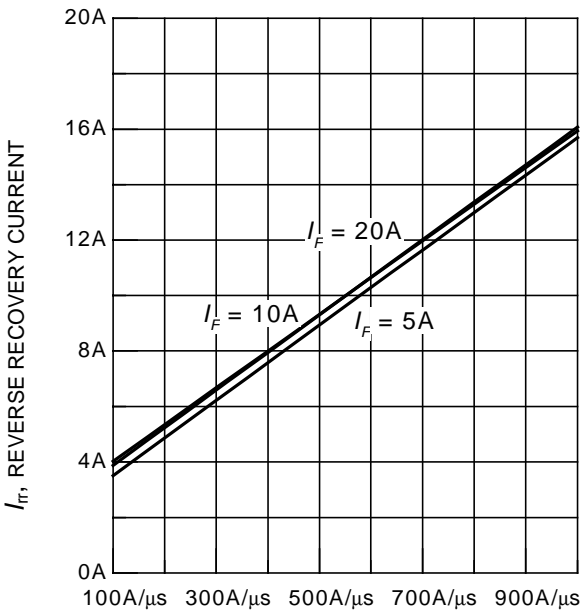

di_F/dt , DIODE CURRENT SLOPE
Figure 23. Typical reverse recovery current as a function of diode current slope
 ($V_R = 200V$, $T_j = 125^\circ C$)

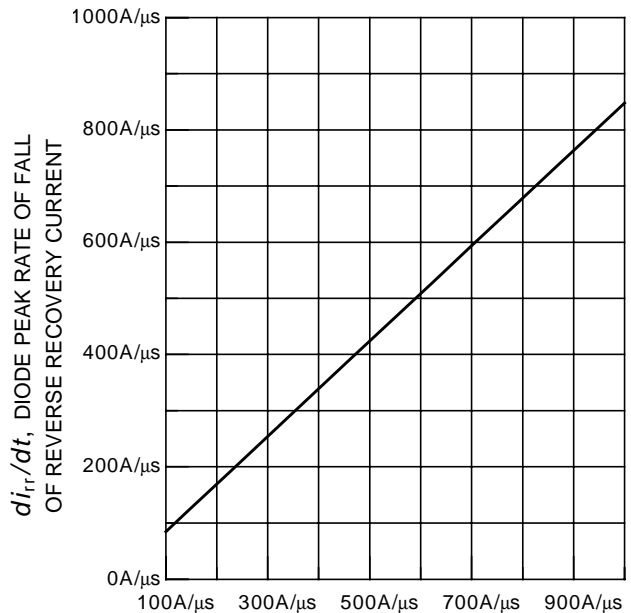

di_F/dt , DIODE CURRENT SLOPE
Figure 24. Typical diode peak rate of fall of reverse recovery current as a function of diode current slope
 ($V_R = 200V$, $T_j = 125^\circ C$)

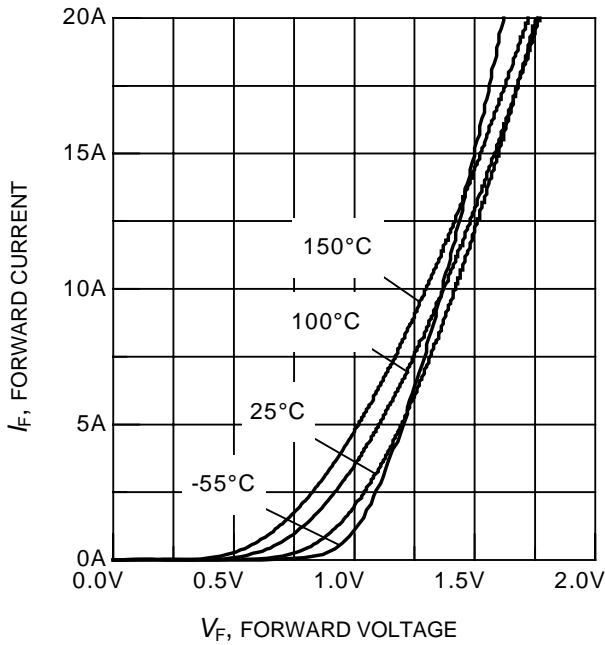

Figure 25. Typical diode forward current as a function of forward voltage

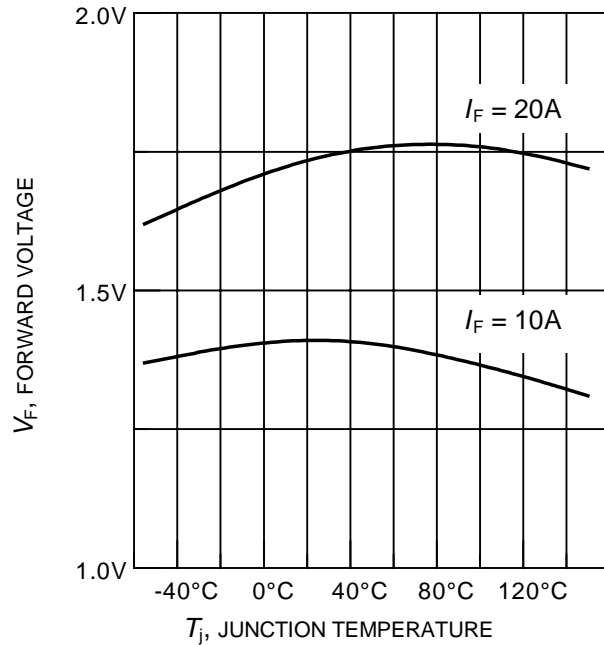

Figure 26. Typical diode forward voltage as a function of junction temperature

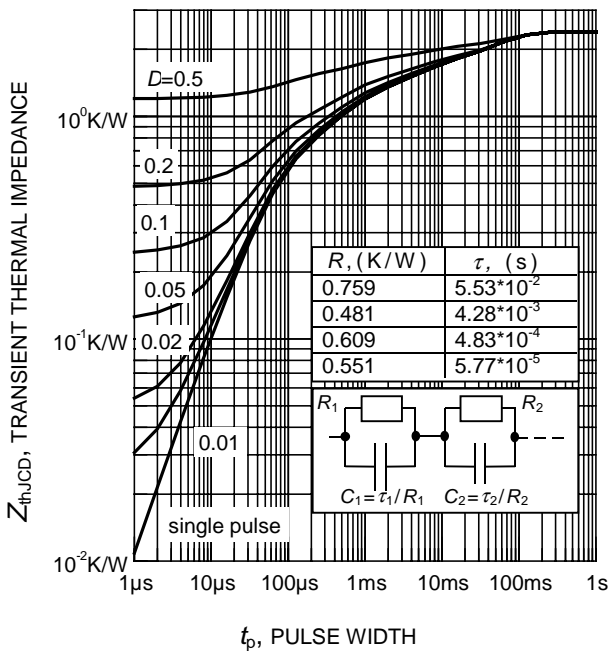
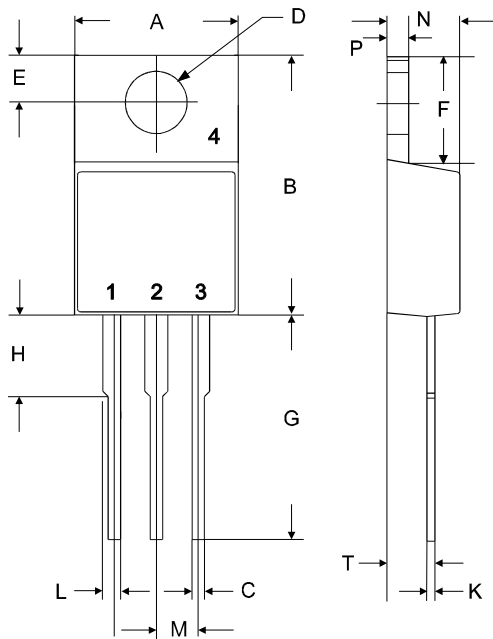

Figure 27. Diode transient thermal impedance as a function of pulse width ($D = t_p / T$)

TO-220AB



symbol	dimensions			
	[mm]		[inch]	
	min	max	min	max
A	9.70	10.30	0.3819	0.4055
B	14.88	15.95	0.5858	0.6280
C	0.65	0.86	0.0256	0.0339
D	3.55	3.89	0.1398	0.1531
E	2.60	3.00	0.1024	0.1181
F	6.00	6.80	0.2362	0.2677
G	13.00	14.00	0.5118	0.5512
H	4.35	4.75	0.1713	0.1870
K	0.38	0.65	0.0150	0.0256
L	0.95	1.32	0.0374	0.0520
M	2.54 typ.		0.1 typ.	
N	4.30	4.50	0.1693	0.1772
P	1.17	1.40	0.0461	0.0551
T	2.30	2.72	0.0906	0.1071

TO-263AB (D²Pak)

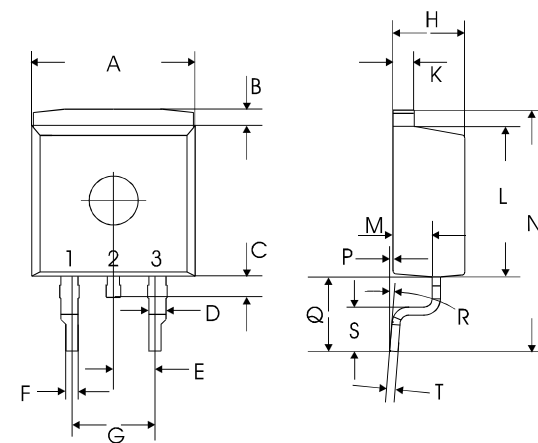

Footprint
(dif. scale)

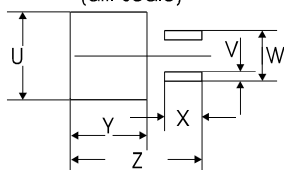

symbol	dimensions			
	[mm]		[inch]	
	min	max	min	max
A	9.80	10.20	0.3858	0.4016
B	0.70	1.30	0.0276	0.0512
C	1.00	1.60	0.0394	0.0630
D	1.03	1.07	0.0406	0.0421
E	2.54 typ.		0.1 typ.	
F	0.65	0.85	0.0256	0.0335
G	5.08 typ.		0.2 typ.	
H	4.30	4.50	0.1693	0.1772
K	1.17	1.37	0.0461	0.0539
L	9.05	9.45	0.3563	0.3720
M	2.30	2.50	0.0906	0.0984
N	15 typ.		0.5906 typ.	
P	0.00	0.20	0.0000	0.0079
Q	4.20	5.20	0.1654	0.2047
R	8° max		8° max	
S	2.40	3.00	0.0945	0.1181
T	0.40	0.60	0.0157	0.0236
U	10.80		0.4252	
V	1.15		0.0453	
W	6.23		0.2453	
X	4.60		0.1811	
Y	9.40		0.3701	
Z	16.15		0.6358	

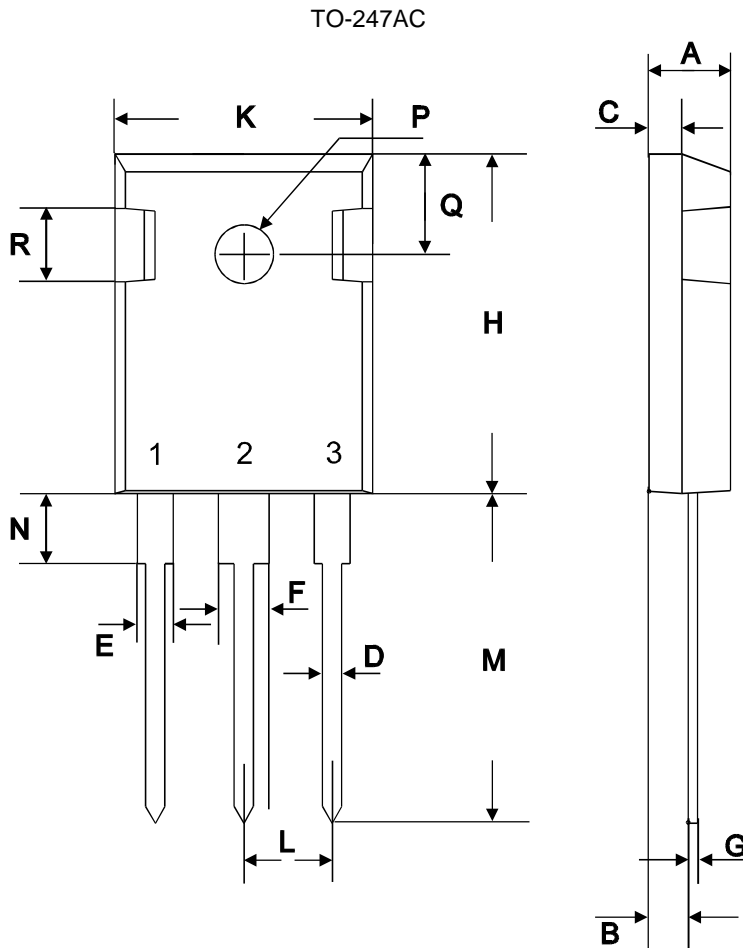

symbol	dimensions			
	[mm]		[inch]	
	min	max	min	max
A	4.78	5.28	0.1882	0.2079
B	2.29	2.51	0.0902	0.0988
C	1.78	2.29	0.0701	0.0902
D	1.09	1.32	0.0429	0.0520
E	1.73	2.06	0.0681	0.0811
F	2.67	3.18	0.1051	0.1252
G	0.76 max		0.0299 max	
H	20.80	21.16	0.8189	0.8331
K	15.65	16.15	0.6161	0.6358
L	5.21	5.72	0.2051	0.2252
M	19.81	20.68	0.7799	0.8142
N	3.560	4.930	0.1402	0.1941
∅P	3.61		0.1421	
Q	6.12	6.22	0.2409	0.2449

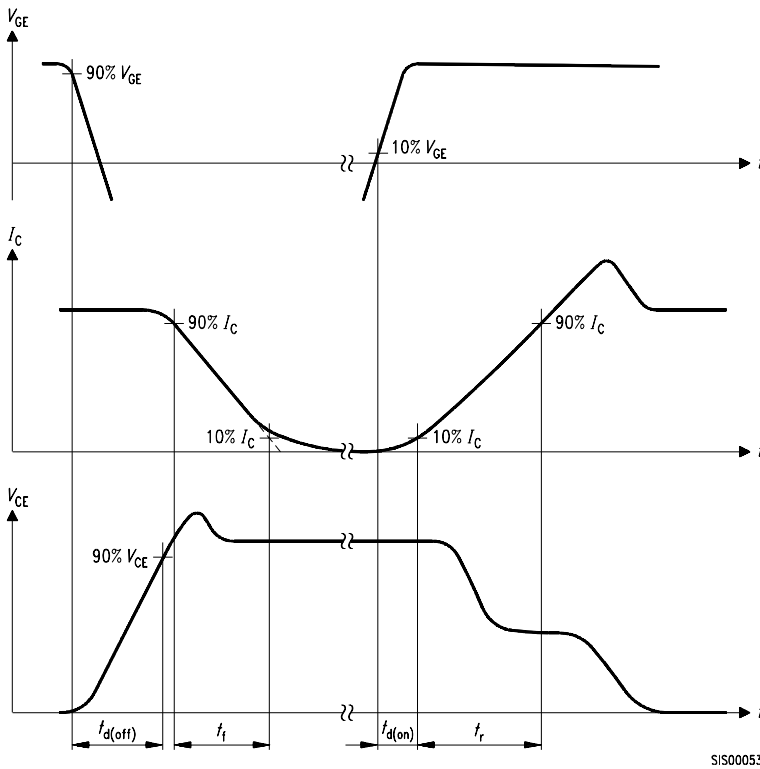

Figure A. Definition of switching times

SIS00053

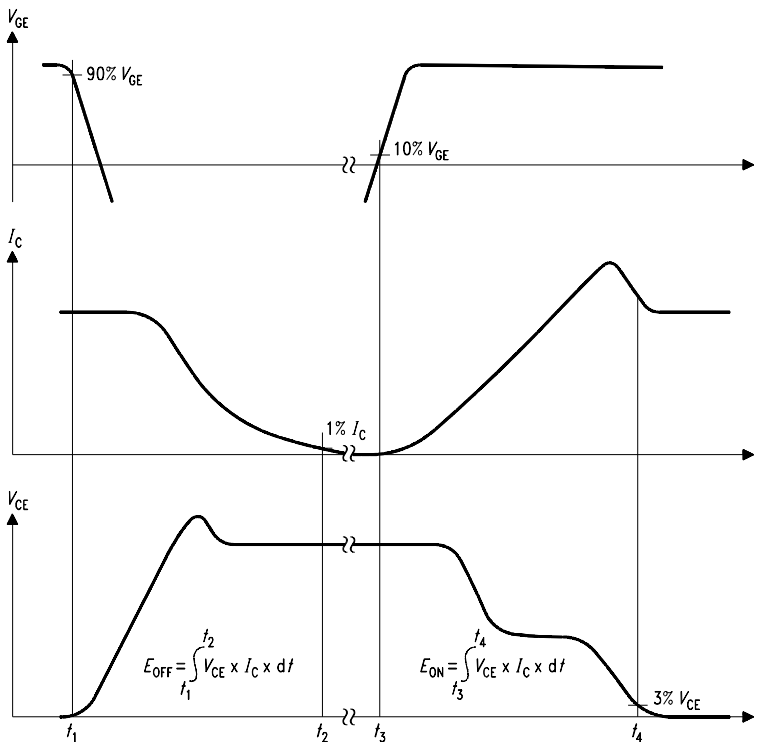

Figure B. Definition of switching losses

SIS00050

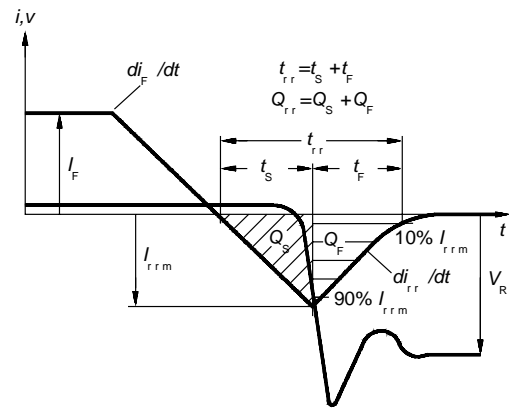

Figure C. Definition of diodes switching characteristics

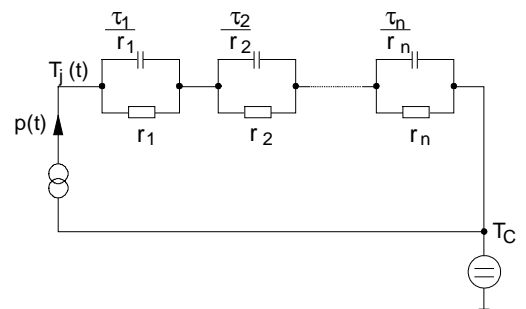

Figure D. Thermal equivalent circuit



SKP10N60

SKB10N60, SKW10N60

Published by
Infineon Technologies AG,
Bereich Kommunikation
St.-Martin-Strasse 53,
D-81541 München
© Infineon Technologies AG 2000
All Rights Reserved.

Attention please!

The information herein is given to describe certain components and shall not be considered as warranted characteristics.

Terms of delivery and rights to technical change reserved.

We hereby disclaim any and all warranties, including but not limited to warranties of non-infringement, regarding circuits, descriptions and charts stated herein.

Infineon Technologies is an approved CECC manufacturer.

Information

For further information on technology, delivery terms and conditions and prices please contact your nearest Infineon Technologies Office in Germany or our Infineon Technologies Representatives worldwide (see address list).

Warnings

Due to technical requirements components may contain dangerous substances. For information on the types in question please contact your nearest Infineon Technologies Office.

Infineon Technologies Components may only be used in life-support devices or systems with the express written approval of Infineon Technologies, if a failure of such components can reasonably be expected to cause the failure of that life-support device or system, or to affect the safety or effectiveness of that device or system. Life support devices or systems are intended to be implanted in the human body, or to support and/or maintain and sustain and/or protect human life. If they fail, it is reasonable to assume that the health of the user or other persons may be endangered.