

# SKT 160

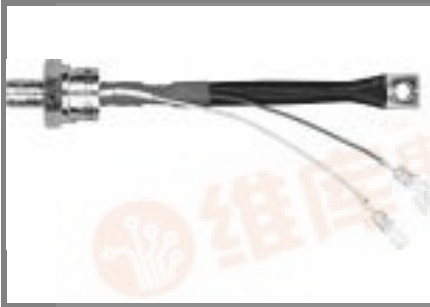

Stud Thyristor

## Line Thyristor

### SKT 160

#### Features

- Hermetic metal case with glass insulator
- Threaded stud ISO M16x1,5 or UNF 3/4-16
- International standard case

#### Typical Applications

- DC motor control (e. g. for machine tools)
- Controlled rectifiers (e. g. for battery charging)
- AC controllers (e. g. for temperature control)
- Recommended snubber network e. g. for  $V_{VRMS} \leq 400$  V:  
 $R = 33 \Omega / 13$  W,  $C = 0,47 \mu F$

1) Available with UNF thread 3/4-16 UNF2A; e. g. SKT 160/12E UNF

$V_{RSM}$ V	$V_{RRM}; V_{DRM}$ V	$I_{TRMS} = 280$ A (maximum value for continuous operation) $I_{TAV} = 160$ A (sin. 180; $T_c = 84$ °C)		
500	400	SKT 160/04D		
700	600	SKT 160/06D		
900	800	SKT 160/08D		
1300	1200	SKT 160/12E <sup>1)</sup>		
1500	1400	SKT 160/14E		
1700	1600	SKT 160/16E <sup>1)</sup>		

Symbol	Conditions	Values	Units
$I_{TAV}$	sin. 180; $T_c = 100$ (85) °C;	116 (158)	A
$I_D$	K1,1; $T_a = 45$ °C; B2 / B6	110 / 150	A
	K0,55; $T_a = 45$ °C; B2 / B6	170 / 240	A
$I_{RMS}$	K0,55; $T_a = 45$ °C; W1C	190	A
$I_{TSM}$	$T_{vj} = 25$ °C; 10 ms	4300	A
	$T_{vj} = 130$ °C; 10 ms	3750	A
$i^2t$	$T_{vj} = 25$ °C; 8,35 ... 10 ms	92500	A <sup>2</sup> s
	$T_{vj} = 130$ °C; 8,35 ... 10 ms	70000	A <sup>2</sup> s
$V_T$	$T_{vj} = 25$ °C; $I_T = 500$ A	max. 1,75	V
$V_{T(TO)}$	$T_{vj} = 130$ °C	max. 1	V
$r_T$	$T_{vj} = 130$ °C	max. 1,5	mΩ
$I_{DD}; I_{RD}$	$T_{vj} = 130$ °C; $V_{RD} = V_{RRM}; V_{DD} = V_{DRM}$	max. 50	mA
$t_{gd}$	$T_{vj} = 25$ °C; $I_G = 1$ A; $di_G/dt = 1$ A/μs	1	μs
$t_{gr}$	$V_D = 0,67 * V_{DRM}$	2	μs
$(di/dt)_{cr}$	$T_{vj} = 130$ °C	max. 100	A/μs
$(dv/dt)_{cr}$	$T_{vj} = 130$ °C; SKT ...D / SKT ...E	max. 500 / 1000	V/μs
$t_q$	$T_{vj} = 130$ °C,	120	μs
$I_H$	$T_{vj} = 25$ °C; typ. / max.	150 / 250	mA
$I_L$	$T_{vj} = 25$ °C; $R_G = 33 \Omega$ ; typ. / max.	300 / 600	mA
$V_{GT}$	$T_{vj} = 25$ °C; d.c.	min. 3	V
$I_{GT}$	$T_{vj} = 25$ °C; d.c.	min. 200	mA
$V_{GD}$	$T_{vj} = 130$ °C; d.c.	max. 0,25	V
$I_{GD}$	$T_{vj} = 130$ °C; d.c.	max. 10	mA
$R_{th(j-c)}$	cont.	0,16	K/W
$R_{th(j-c)}$	sin. 180	0,18	K/W
$R_{th(j-c)}$	rec. 120	0,2	K/W
$R_{th(c-s)}$		0,03	K/W
$T_{vj}$		- 40 ... + 130	°C
$T_{stg}$		- 55 ... + 150	°C
$V_{isol}$		-	V~
$M_s$	to heatsink	30	Nm
$a$		5 * 9,81	m/s <sup>2</sup>
$m$	approx.	250	g
Case		B 6	

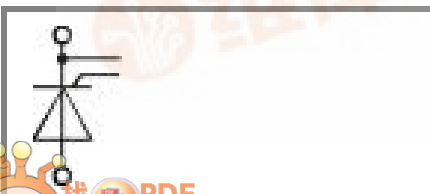

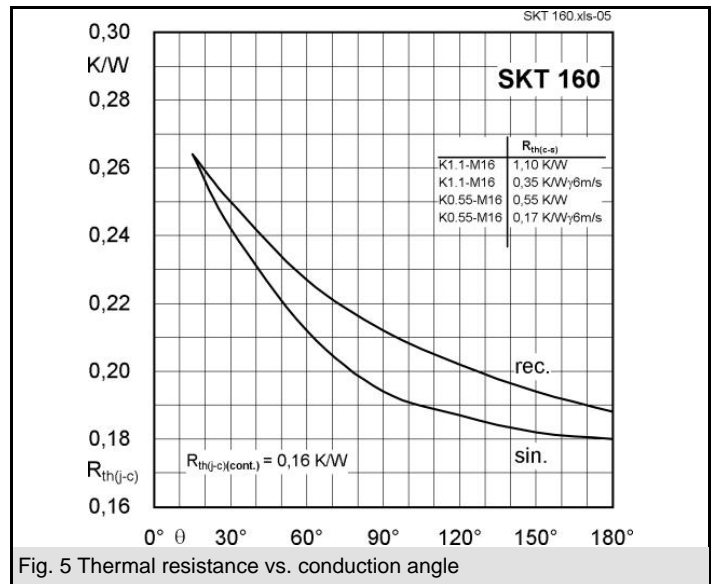
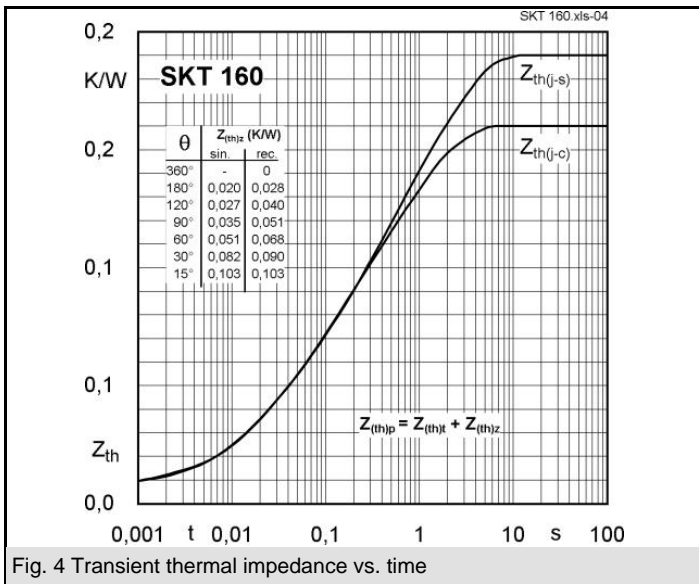
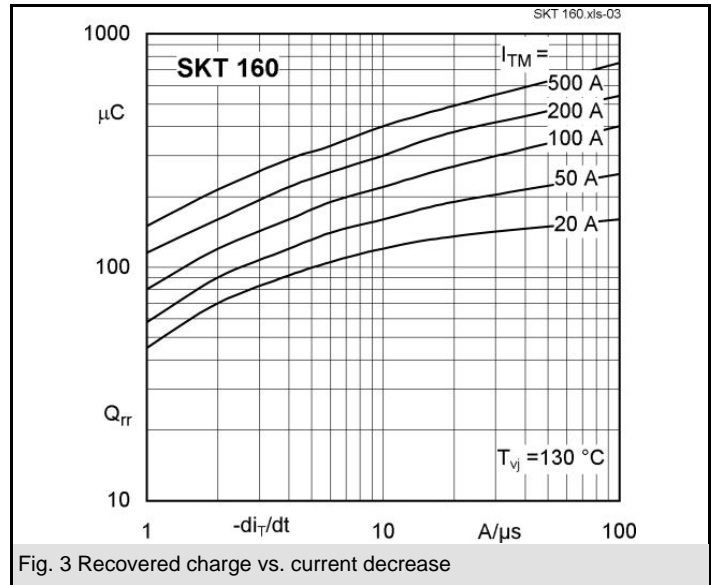
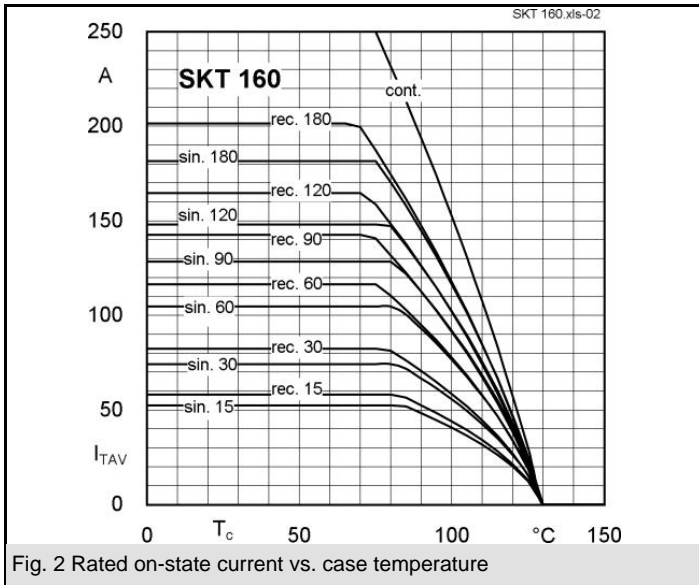
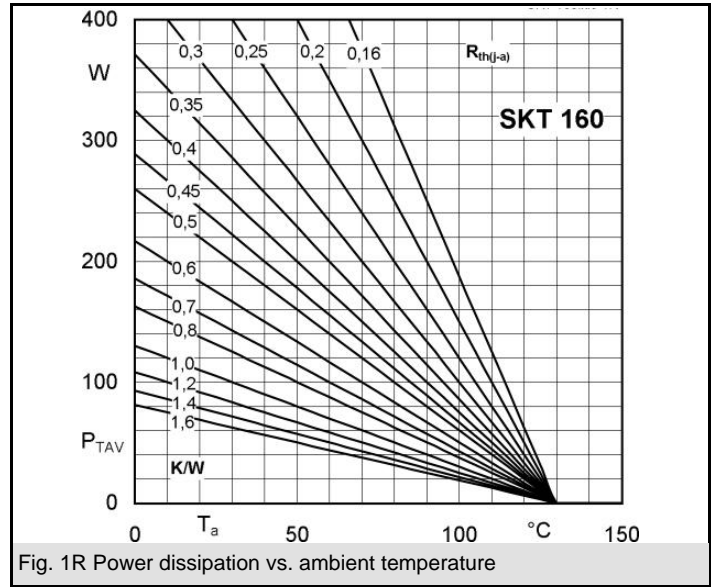
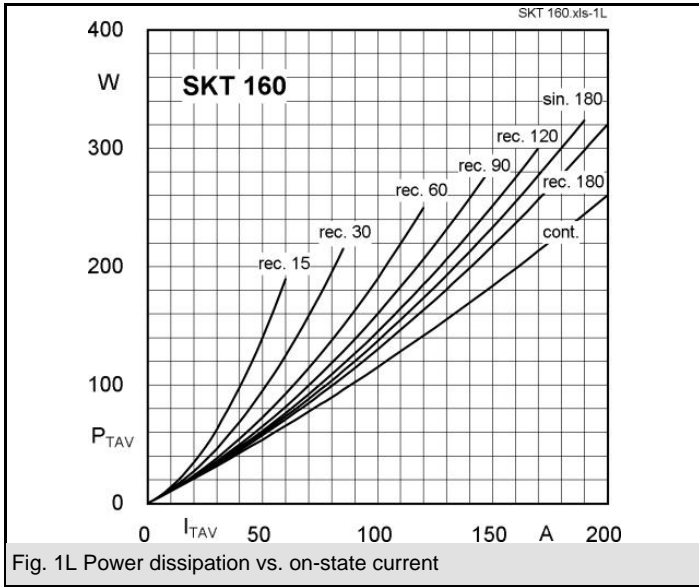

# SKT 160

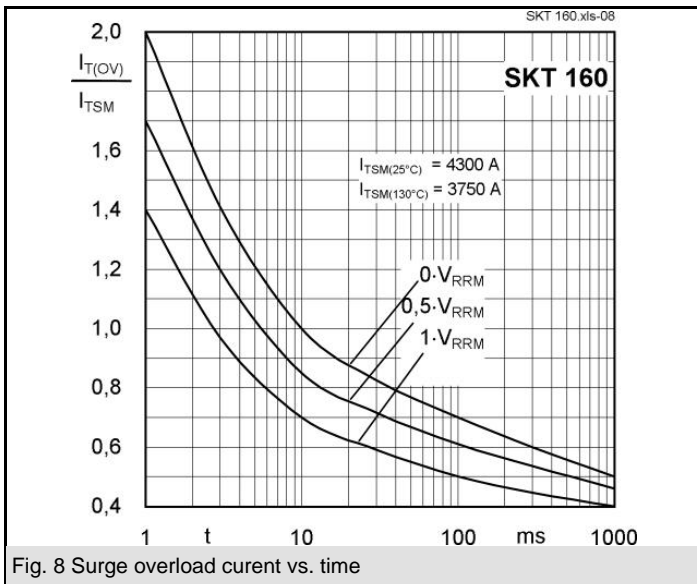
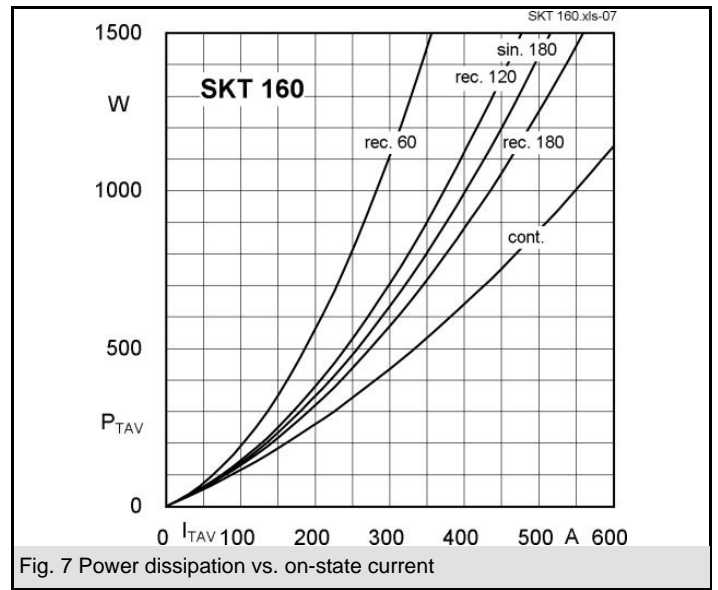
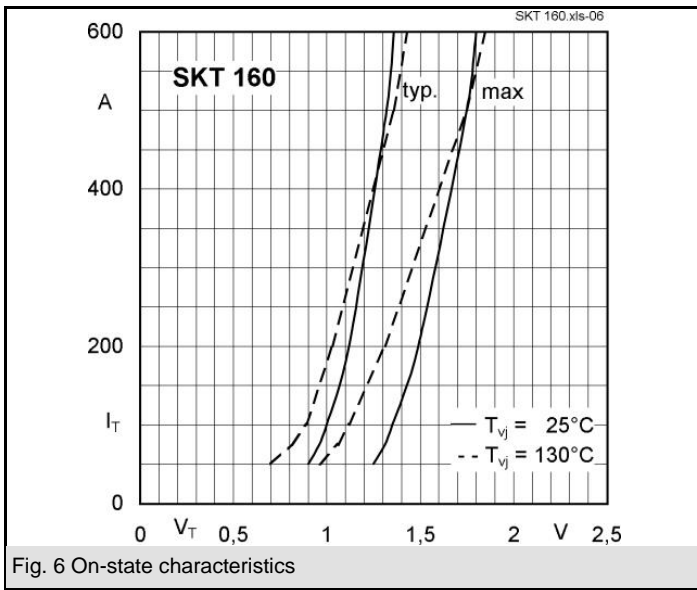

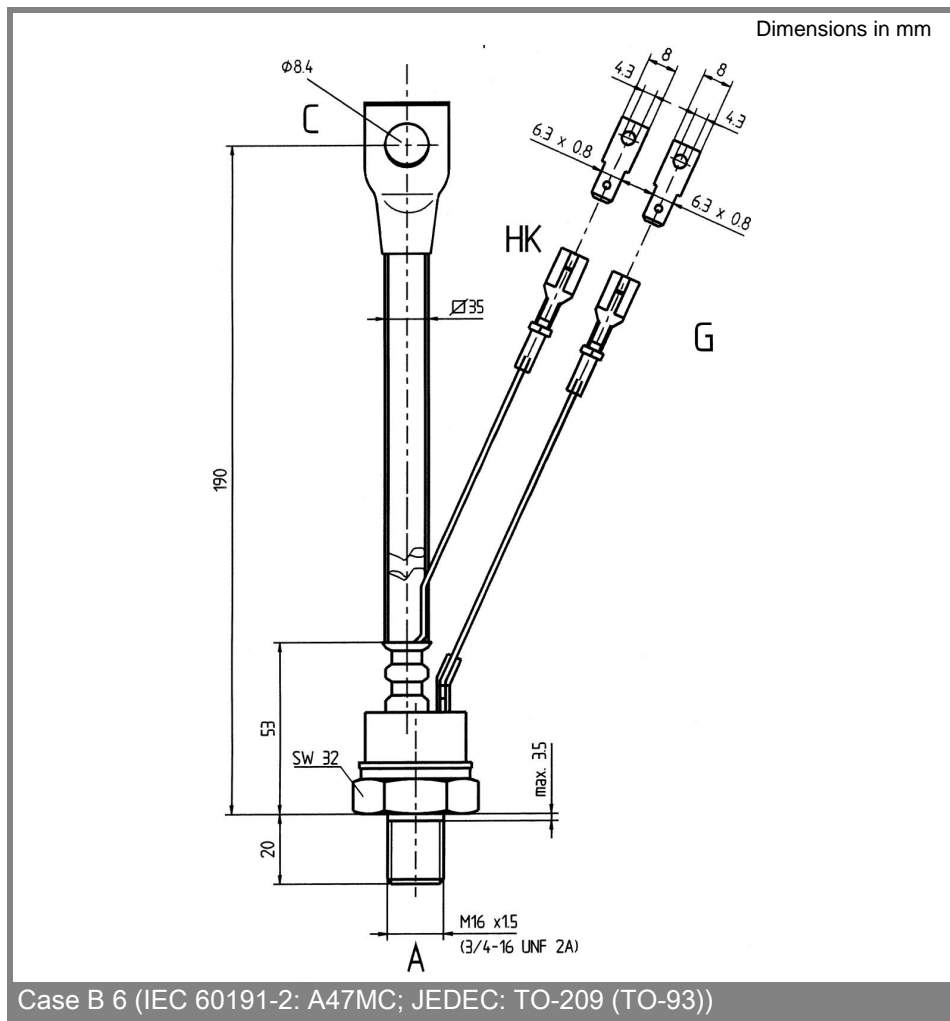
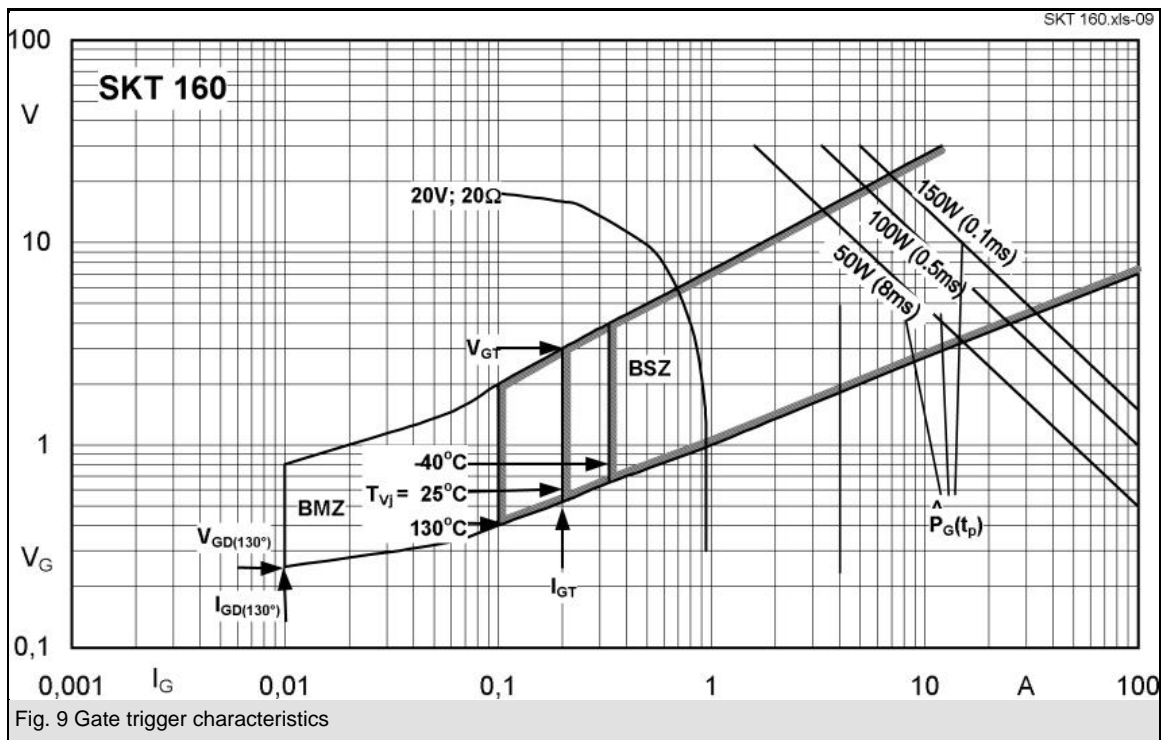

This technical information specifies semiconductor devices but promises no characteristics. No warranty or guarantee expressed or implied is made regarding delivery, performance or suitability.