

# SKET 740

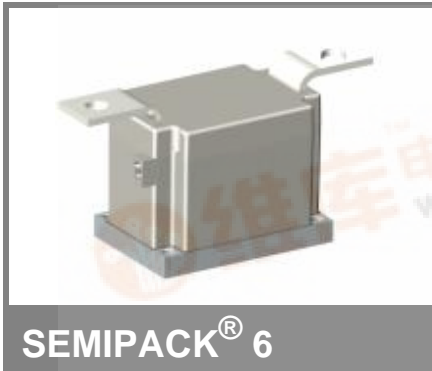

## Thyristor Modules

### SKET 740

#### Preliminary Data

#### Features

- Precious metal pressure contacts for high reliability
- Thyristor with amplifying gate
- UL recognized, file no. E 63 532

#### Typical Applications

- DC motor control (e. g. for machine tools)
- Temperature control (e. g. for ovens, chemical processes)
- Softstart application

1) calculated with characteristic values

2) characteristic values

3)  $T_{vjmax}$  up to 130°C is allowable for overload conditions, max. time periode for the overload condition is 20s

$V_{RSM}$ V	$V_{RRM}; V_{DRM}$ V	$I_{TRMS} = 1500$ A (maximum value for continuous operation) $I_{TAV} = 740$ A (sin. 180; $T_c = 82$ °C)	
1900	1800	SKET 740/18G H4	
2300	2200	SKET 740/22G H4	

Symbol	Conditions	Values	Units
$I_{TAV}$	sin. 180; $T_c = 85$ (100) °C;	700 (490)	A
$I_{TAV(typ.)}^{1)}$	sin. 180; $T_c = 85$ (100) °C;	745 (520)	A
$I_{TSM}$	$T_{vj} = 25$ °C; 10 ms	36000	A
$i^2t$	$T_{vj} = 125$ °C; 10 ms	31000	A
	$T_{vj} = 25$ °C; 8,3 ... 10 ms	6480000	A <sup>2</sup> s
	$T_{vj} = 125$ °C; 8,3 ... 10 ms	4805000	A <sup>2</sup> s
$V_T$	$T_{vj} = 25$ °C; $I_T = 3000$ A	max. 1,65	V
$V_{T(typ.)}^{2)}$	$T_{vj} = 25$ °C; $I_T = 3000$ A	1,55	V
$V_{T(TO)}$	$T_{vj} = 125$ °C	max. 0,88	V
$r_T$	$T_{vj} = 125$ °C	max. 0,28	mΩ
$V_{T(TO)(typ.)}^{2)}$	$T_{vj} = 125$ °C	0,82	V
$r_{T(typ.)}^{2)}$	$T_{vj} = 125$ °C	0,25	mΩ
$I_{DD}; I_{RD}$	$T_{vj} = 125$ °C; $V_{RD} = V_{RRM}; V_{DD} = V_{DRM}$	max. 150	mA
$t_{gd}$	$T_{vj} = 25$ °C; $I_G = 1$ A; $di_G/dt = 1$ A/μs	1	μs
$t_{gr}$	$V_D = 0,67 * V_{DRM}$	2	μs
$(di/dt)_{cr}$	$T_{vj} = 125$ °C	max. 200	A/μs
$(dv/dt)_{cr}$	$T_{vj} = 125$ °C	max. 2000	V/μs
$t_q$	$T_{vj} = 125$ °C	200	μs
$I_H$	$T_{vj} = 25$ °C; typ. / max.	1000 / 2000	mA
$I_L$	$T_{vj} = 25$ °C; $R_G = 33$ Ω; typ. / max.	1500 / 2500	mA
$V_{GT}$	$T_{vj} = 25$ °C; d.c.	min. 3	V
$I_{GT}$	$T_{vj} = 25$ °C; d.c.	min. 300	mA
$V_{GD}$	$T_{vj} = 125$ °C; d.c.	max. 0,25	V
$I_{GD}$	$T_{vj} = 125$ °C; d.c.	max. 10	mA
$R_{th(j-c)}$	cont.	0,0405	K/W
$R_{th(j-c)}$	sin. 180	0,042	K/W
$R_{th(j-c)}$	rec. 120	0,043	K/W
$R_{th(c-s)}$		0,01	K/W
$T_{vj}$		- 40 ... + 125 <sup>3)</sup>	°C
$T_{stg}$		- 40 ... + 125	°C
$V_{isol}$	a. c. 50 Hz; r.m.s.; 1s / 1 min.	4800 / 4000	V~
$V_{isol}$		745 / 520	V~
$M_s$	to heatsink	6 ± 15 %	Nm
$M_t$	to terminal	18 ± 15 %	Nm
$a$		5 * 9,81	m/s <sup>2</sup>
$m$	approx.	2150	g
Case		A80	



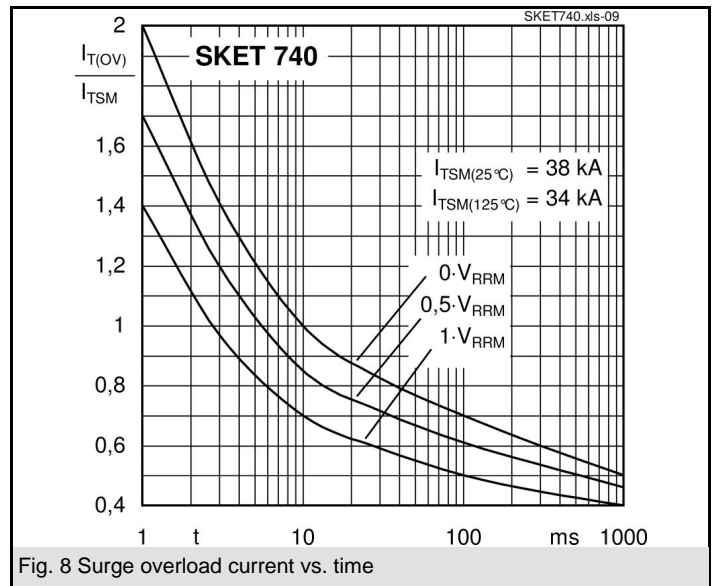
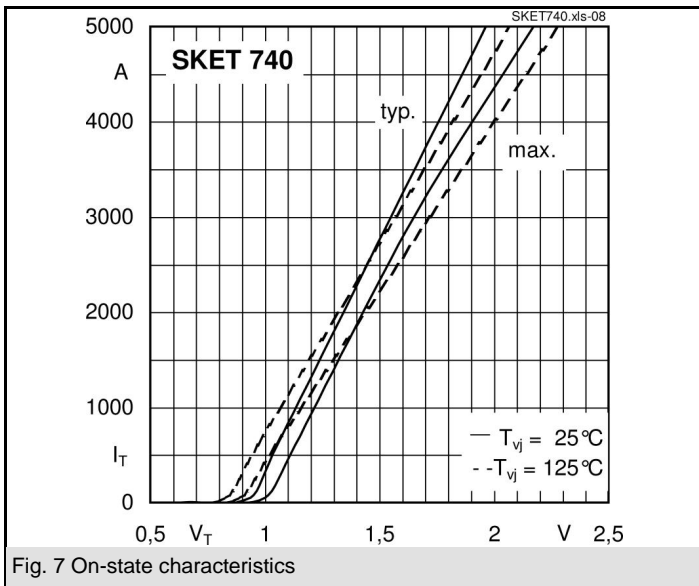
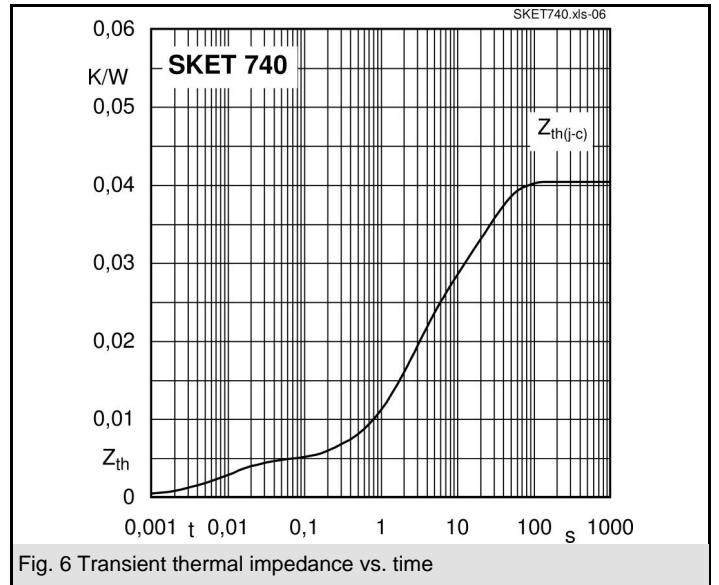
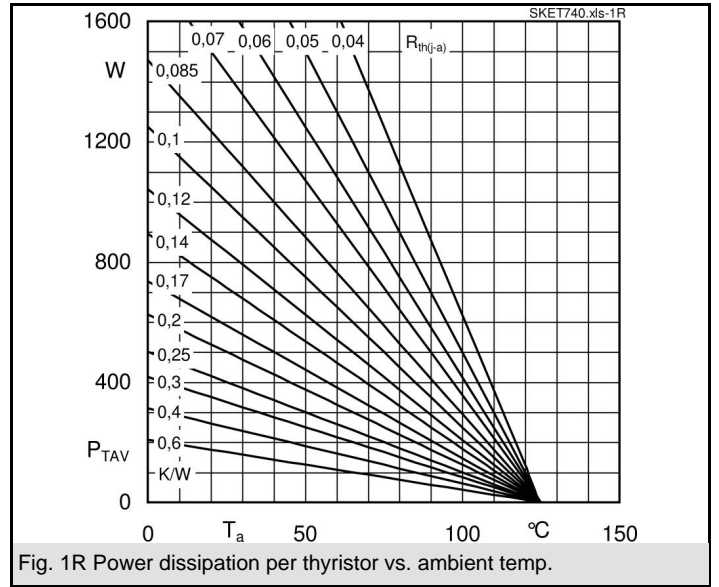
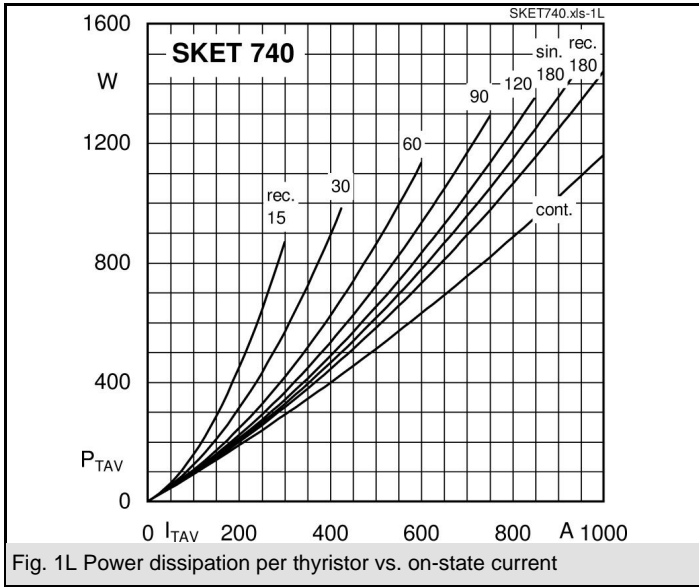

# SKET 740

# THYRISTOR BRIDGE SCR BRIDGE

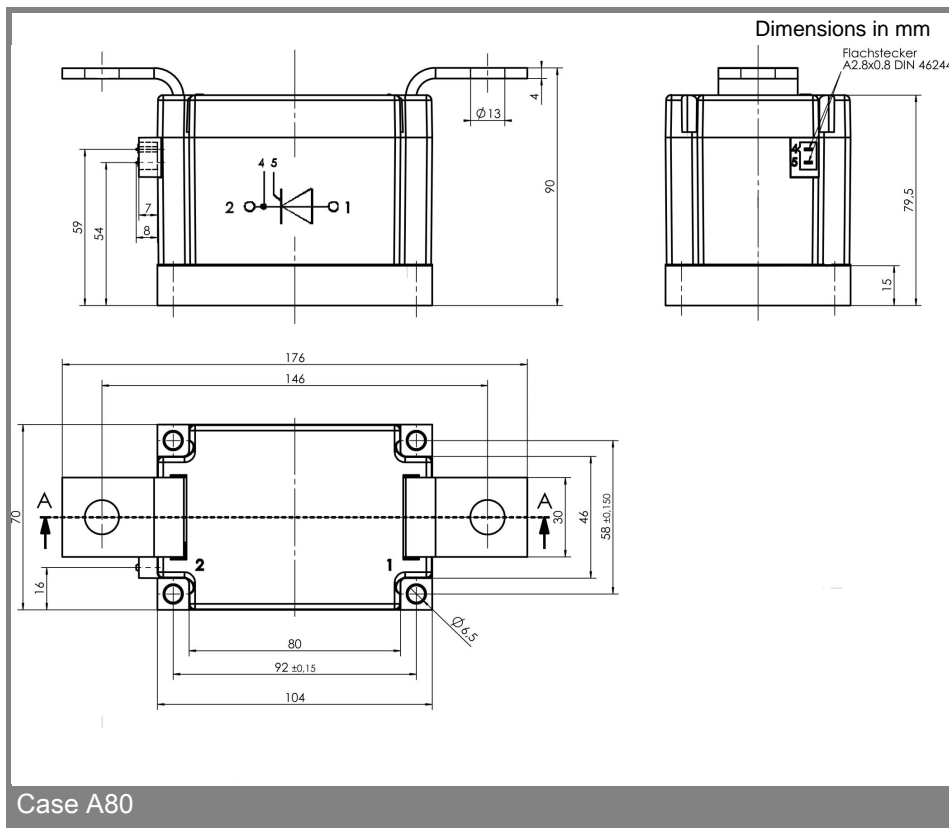

This technical information specifies semiconductor devices but promises no characteristics. No warranty or guarantee expressed or implied is made regarding delivery, performance or suitability.