

FEATURES

- PC half-bridge (or 494) power supply supervisor + PWM
- Highly Integrated and Few external components required
- Over voltage protection 3.3V/5V/12V (two 12V)
- Under voltage protection 3.3V/5V/12V (two 12V)
- Under voltage protection for -12V and/or -5V
- Over current protection 3.3V/5V/12V (two 12V)
- Over power protection
- Short circuit protection
- Power-down warning circuitry
- Power good circuitry
- Delay time for PSON and PG signals
- Remote ON/OFF function
- On-Chip oscillator and Error amplifier
- Latching PWM for cycle-by-cycle switching
- Soft-start
- Maximum 48% duty cycle

APPLICATIONS

Switching mode power supplies for computers such as ATX, NLX, and SFX (micro-ATX).

DESCRIPTION

The SG6108 controller is designed for desktop PC switching mode power supplies. It provides everything necessary to monitor and control the output of the power supply. Remote ON/OFF control, power good circuitry, over-voltage protection, over-power protection, and over-current protection are all included. The SG6108 directly senses all the output rails for over voltage conditions without requiring external dividers. An innovative AC-signal sampling circuit provides an adequate power-down warning signal for PG. A built-in timer generates accurate timing for the control circuit.

Cycle-by-cycle PWM switching protects the power transformer from saturation and ensures a rapid response for short-circuit protection. This greatly reduces the stress on the power transistors. The SG6108 utilizes a minimum number of external components while including all the functions needed for push-pull and/or half-bridge topologies. This decreases production costs and PCB space while increasing the power supply's MTBF.

TYPICAL APPLICATION

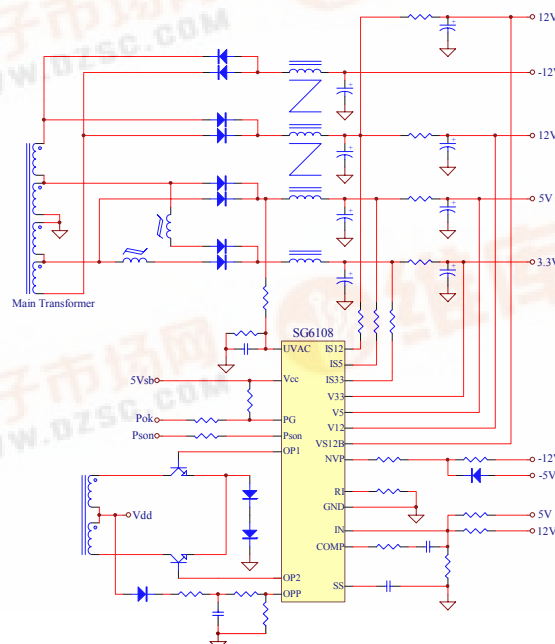

MARKING DIAGRAMS

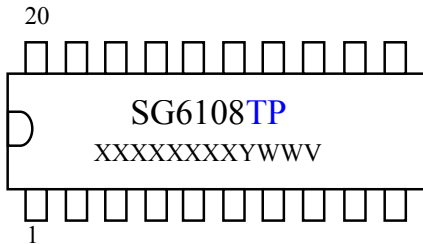

T : D = DIP
 P : Z = Lead Free
 Null=regular package
 XXXXXXXX: Wafer Lot
 Y: Year; WW: Week
 V: Assembly Location

PIN CONFIGURATION

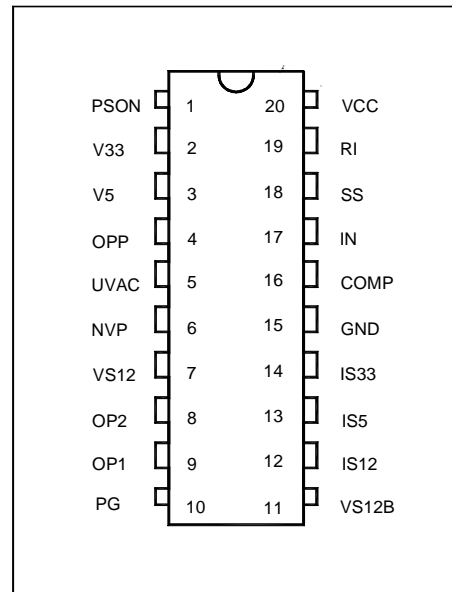

ORDERING INFORMATION

Part Number	Pb-Free	Package
SG6108DZ		20-Pin DIP

PIN DESCRIPTIONS

Name	Pin	Type	Function
PSON	1	Logic Input	Remote On/Off logic input for the CPU or the controller. Turns the PWM output on/off following a 45 msec / 16 msec delay. PSON = 0 means that the main SMPS is operational. PSON = 1 means that the main SMPS is off and the latch is reset.
V33	2	Analog Input	3.3V over-voltage/under-voltage control sense input.
V5	3	Analog Input	5V over-voltage/under-voltage control sense input.
OPP	4	Analog Input	Over-power sense input. This pin is connected to the driver transformer or the output of the current transformer. When not in use, this pin should be grounded.
UVAC	5	Analog Input	AC fail-detection. This detects main AC voltage under-voltage and/or failure.
NVP	6	Analog Input	The protection input for negative outputs, such as -12V and/or -5V. Trip voltage = 2.1V.
VS12	7	Analog Input	12V over-voltage/under-voltage control sense input.
OP2/OP1	8/9	Analog Output	The totem-pole output drivers of a push-pull PWM. The outputs are enabled (low) only when the NAND gate inputs are high. The maximum duty cycle on an output (OP1 or OP2) is 48%.
PG	10	Logic Output	Power Good logic output, 0 or 1 (open-collector). PG = 1 means that the power is good for operation. The PG delay is 300 msec.
VS12B	11	Analog Input	Second 12V over-voltage/under-voltage control sense input.
IS12	12	Analog Input	12V over current protection sense input. The sink current = 8 x IRI
IS5	13	Analog Input	5V over current protection sense input. The sink current = 8 x IRI
IS33	14	Analog Input	3.3V over current protection sense input. The sink current = 8 x IRI
GND	15	Supply	Ground.
COMP	16	Analog Output	The error amplifier output and the input of the PWM comparator.
IN	17	Analog Input	The negative input of the error amplifier. The positive input of the error amplifier is a 2.5V reference voltage.
SS	18	Analog Input	Soft-start. This can be set through the external capacitor. The current source output at this pin is 8uA and the voltage is clamped at 2.5V.
RI	19	Program. Analog Input	This is connected to the external resistor to provide a reference setting. It determines the PWM frequency, and also the OCP current setting. Setting RI = 75kΩ will result in a PWM frequency of 65kHz. Do not attach a capacitor to this pin. For OCP current settings please refer to the Over Current Protection section on page 13.
VCC	20	Supply	Supply voltage. 4.5V ~ 5.5V. It is connected to the 5V-standby.

BLOCK DIAGRAM

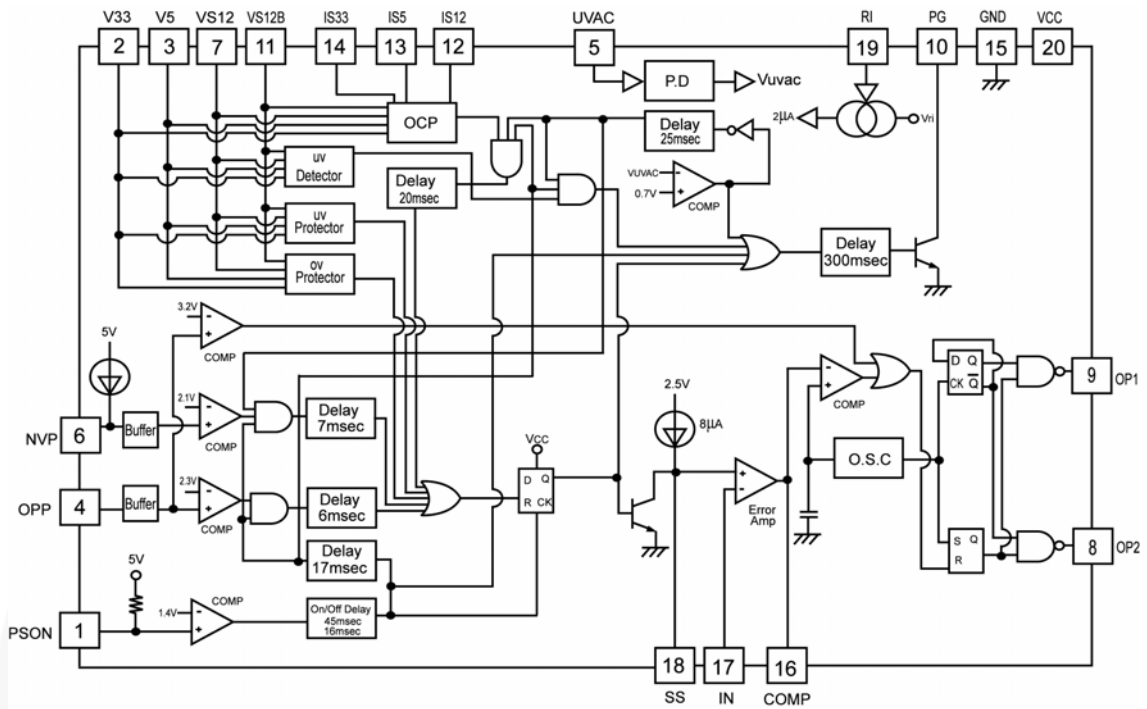

TIMING DIAGRAM

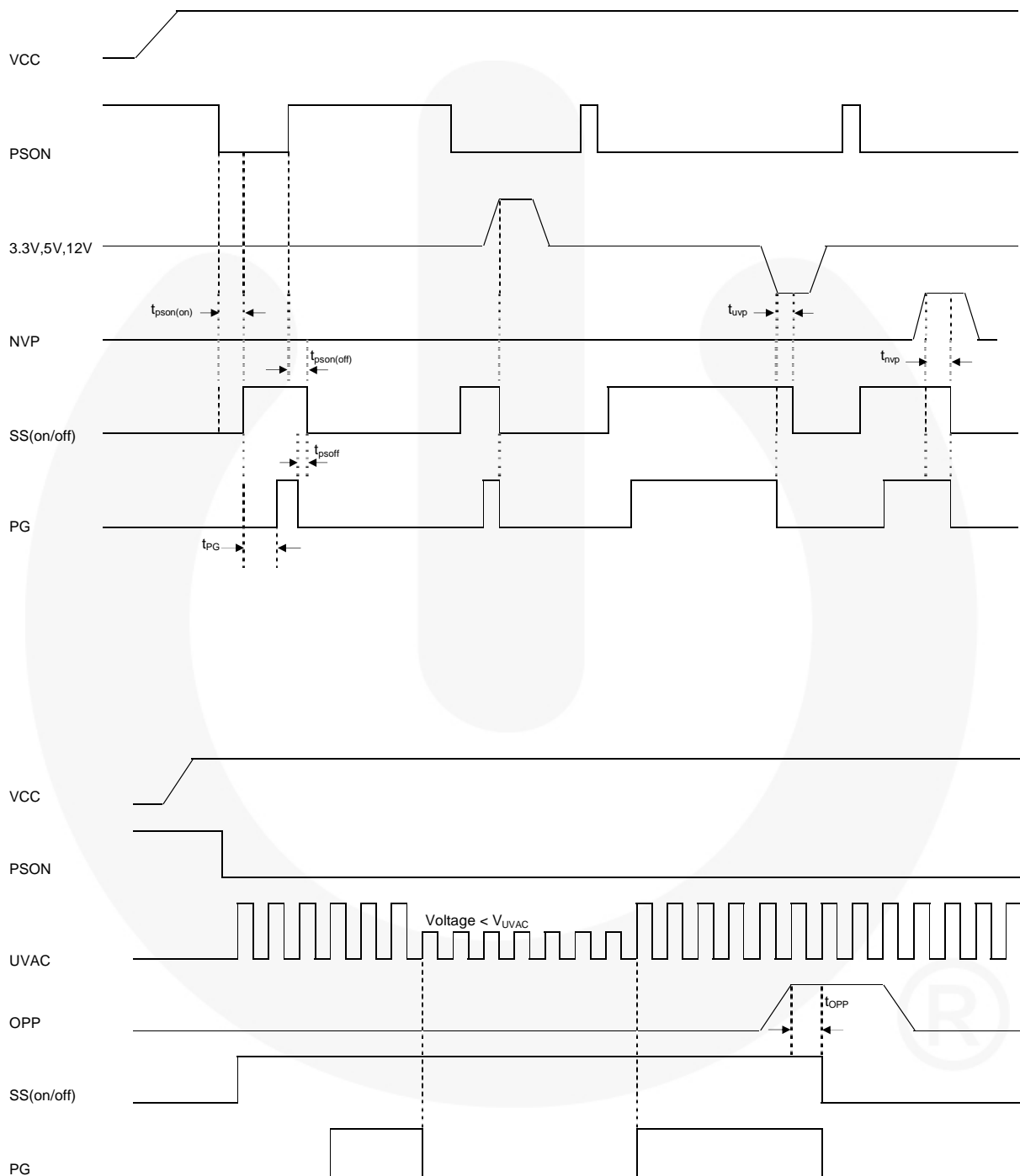

ABSOLUTE MAXIMUM RATINGS

Symbol	Parameter	Value	Unit
V _{CC, MAX}	DC Supply Voltage at Pin 20	6	V
I _{OUT}	Input Current at PG,FB Pins	30	mA
V _{PIN, MAX}	OP1, OP2, VS12, VS12B, IS12	-0.3 to 16	V
	OPP, UVAC, RI, SS, PG, IN, COMP, FB, NVP, IS5, V33, V5, PSON	-0.3 to 7	V
P _{D,25°C}	Power Dissipation (T _A =25°C)	1.5	W
P _{D,90°C}	Power Dissipation (T _A =90°C)	0.5	W
T _{STG}	Storage Temperature Range	-55 to +150	°C
R _{θJA}	Thermal Resistance, Junction-To-Case	28.58	°C/W
T _{J,MAX}	Operating Junction Temperature	150	°C
T _{A,MAX}	Operating Ambient Temperature	-20 to +85	°C
T _L	Lead Temperature (Wave soldering or IR, 10seconds)	260	°C
	ESD Capability, HBM model	3.0	KV
	ESD Capability, Machine model	200	V

* All voltage values, except the differential voltage, are given with respect to the network ground terminal.

* Stresses beyond those listed under “absolute maximum ratings” may cause permanent damage to the device.

RECOMMENDED OPERATING CONDITIONS

Symbol	Parameter	Value	Unit
V _{CC}	DC Supply Voltage	4.5 to 5.5	V
T _A	Operating Ambient Temperature	-20 to +85	°C

* For proper operation

Electrical Characteristics (V_{CC}=5V, T_A = 25°C,RI=75Kohm,unless noted)

VCC Section

Symbol	Parameter	Test Condition	Min.	Typ.	Max.	Unit
I _{CC1}	Total Supply Current	PSON=Low, OP1/OP2 1000pF			10	mA
I _{CC2}	Total Supply Current	PSON=High, OP1/OP2 1000pF		5	10	mA

Protection Section

Symbol	Parameter	Test Condition	Min.	Typ.	Max.	Unit
V _{OV1}	Over-Voltage Protection 3.3V		3.9	4.1	4.3	V
V _{OV2}	Over-Voltage Protection 5V		5.8	6.1	6.5	V
V _{OV3}	Over-Voltage Protection VS12, VS12B		13.75	14.05	14.35	V
V _{UV1}	Under-Voltage Protection 3.3V		2.0	2.6	2.8	V
V _{UV2}	Under-Voltage Protection 5V		3.0	3.6	3.9	V
V _{UV3}	Under-Voltage Protection VS12, VS12B		6.0	7.2	8.0	V
V _{UVS1}	Under-Voltage Sense 3.3V for PG Low		2.5	2.8	3.0	V
V _{UVS2}	Under-Voltage Sense 5V for PG Low		4.0	4.3	4.5	V
V _{UVS3}	Under-Voltage Sense VS12, VS12B for PG Low		9.4	10.1	10.4	V
V _{OPP} * ¹	Over-Power Protection (With T _{OPP} delay time)	V _{UVAC} = 1.5V	2.23	2.3	2.37	V
V _{OPPH}	Over-Power Protection (Without delay time)		3.0	3.2	3.4	V
V _X	Disable Under Voltage / Over Power Protection threshold		0.2	0.3	0.4	V
V _{NVP}	Negative Voltage Protection: Voltage Level		2.0	2.1	2.2	V
I _{NVP}	Negative Voltage Protection: Source Current		57	64	72	uA
T _{UVEDA}	Under Voltage Enable Delay Time	VS12/B = 0.8V	10	17	22	mS
T _{UVEDB}	Under Voltage Enable Delay Time	VS12/B = 5V	22	30	40	mS
T _{OV}	Timing for Over-Voltage Protection		0.37	0.7	1.35	mS
T _{UV}	Timing for Under-Voltage Protection		1.2	2.7	4.2	mS
T _{UVS}	Timing for Under-Voltage Sense (PG Low)		0.9	1.6	2.2	mS
T _{OPP}	Timing for Over-Power-Protection		4	6	8	mS
T _{NVP}	Timing for Negative Voltage Protection		3.3	7	10.2	mS
T _{OC}	Timing for Over-Current Protection		15	20	25	mS
T _{OC(EN)}	Timing for Over-Current Protection Function Enable	SS go Hi, VS12/B=0.8V	10	17	22	mS
		SS go Hi, VS12/B =5V	22	30	40	
V _{OFFSET}	OC Comparator Input Offset Voltage		-5		5	mV
I _{REF}	Ratio of IS33, IS5, IS12 to RI Current Setting		7.6	8	8.4	
I _{LK33}	V33 Leakage Current	V33 = 3.3V			50	uA
I _{LK5}	V5 Leakage Current	V5 = 5V			50	uA
I _{LK12AB}	VS12, VS12B Leakage Current	VS12 =12V VS12B = 12V			50	uA

Note ¹: V_{OPP} = (2/3) x V_{OPP} + (1/3) x V_{UVAC} ;

Power Good Section

Symbol	Parameter	Test Condition	Min.	Typ.	Max.	Unit
T _{PG}	Timing for PG Delay		200	300	400	mS
T _{UVAC}	Timing for PG Fail	UVAC to PG	75	150	300	uS
V _{UVAC}	UVAC Voltage Sense for PG		0.68	0.7	0.72	V
V _{UVAC(DIS)}	Disable UVP,NVP,OCV Voltage		0.68	0.7	0.72	V
T _{UVAC(DIS)}	Timing for Disable UVP,NVP,OCV	UVAC < V _{UVAC(DIS)}	75	150	300	uS
T _{UVAC(EN)}	Timing for Enable UVP,NVP,OCV	UVAC > V _{UVAC(DIS)}	15	25	35	mS
T _R ^{*2}	PG Output Rising Time	CL =100pF Pull 2.2K to 5V		1	3	uS
T _F ^{*2}	PG Falling Time	CL =100pF Pull 2.2K to 5V		300	500	nS
V _{OL2}	Power Good Output Saturation Level	I _{PG} = 5mA			0.5	V
I _{IO2}	Power Good Leakage Current	V _{PG} = 5V			1	uA

Note ²: Not tested in production test;

Power Supply Supervisor + PWM
SG6108
Remote On/Off

Symbol	Parameter	Test Condition	Min.	Typ.	Max.	Unit
V _{PSON}	PSON Input Threshold Level		1	1.4	2.0	V
I _{PSON}	Remote Input Driving Current				0.5	mA
T _{PSON(ON)}	PSON to On/Off Time On		25	45	65	mS
T _{PSON(OFF)}	Off		8	16	24	
T _{PSOFF}	PG Low to Power Off Time		1.5	2	6.3	mS

Error Amplifier

Symbol	Parameter	Test Condition	Min.	Typ.	Max.	Unit
V _{2.5}	Reference Voltage		2.45	2.5	2.55	V
I _{IB} ^{*2}	Input Bias Current				0.1	uA
V _{DEV.T2.5} ^{*2}	Deviation of V _{2.5} Over Temperature			10	30	mV
I _{COSI}	I _{COMP} Source Current	IN Short COMP VCOMP=2.4V	0.4			mA
I _{COSO}	I _{COMP} Sink Current	IN Short COMP VCOMP=2.6V	1.2			mA
A _{VOL} ^{*2}	Open-Loop Voltage Gain		50	60		dB
BW ^{*2}	Unity Gain Bandwidth		0.3	1		MHz
PSRR ^{*2}	Power Supply Rejection Ratio		50			dB

Oscillator Section

Symbol	Parameter	Test Condition	Min.	Typ.	Max.	Unit
F _{OSC}	PWM Frequency		60	65	70	KHz
DC _{MAX}	Max Duty Cycle		41	44.5	48	%
R _I	RI Resistor Range		70		105	KΩ
V _{REFRI}	RI Reference Voltage		0.98	1	1.02	V
T _{DEAD}	PWM Dead Time		1.3	1.7	2.1	uS

Soft-Start Section

Symbol	Parameter	Test Condition	Min.	Typ.	Max.	Unit
I _{SS}	Charge Current		6.7	8	9.3	uA
I _{SSINK}	Sink Current		1			mA

PWM Output Section (OP1, OP2)

Symbol	Parameter	Test Condition	Min.	Typ.	Max.	Unit
V _{OL}	Output Voltage Low	I _o = 20mA			1	V
V _{OH}	Output Voltage High	VDD = 5V	4			V
R _O	Output Impedance of V _{OH}		0.8		2.6	kΩ

TYPICAL CHARACTERISTICS

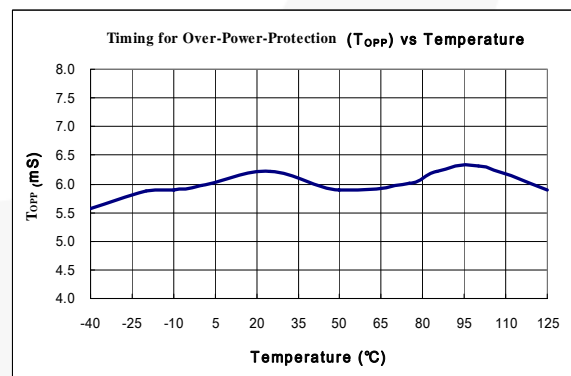
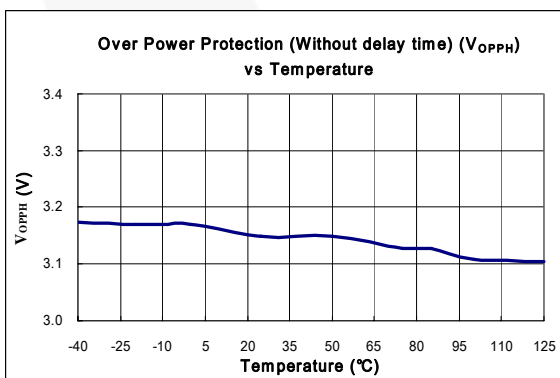
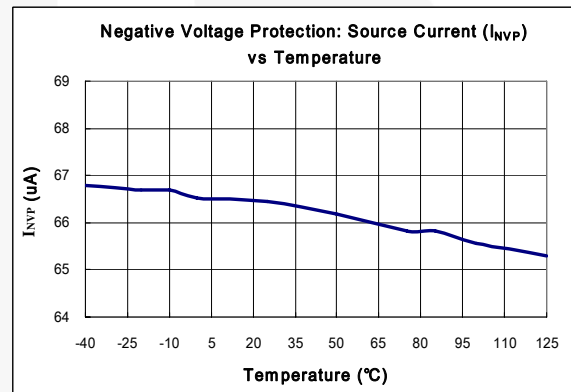
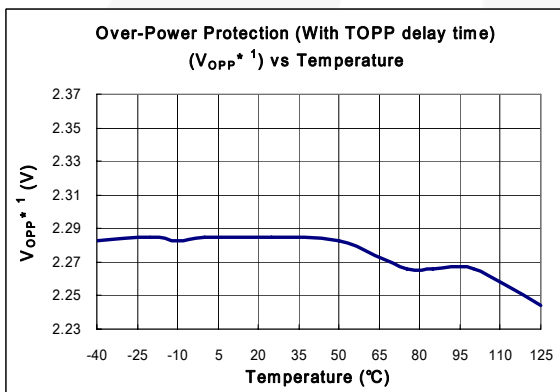
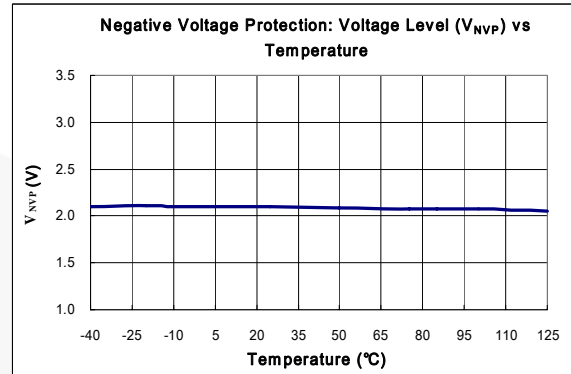
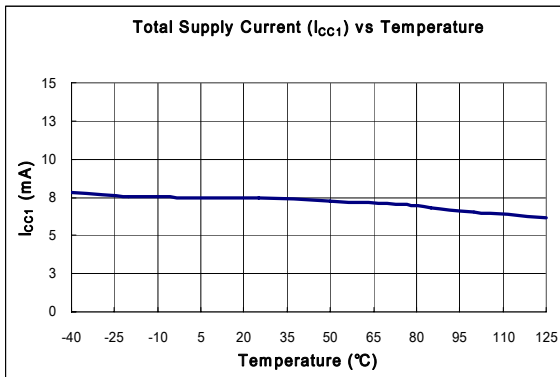

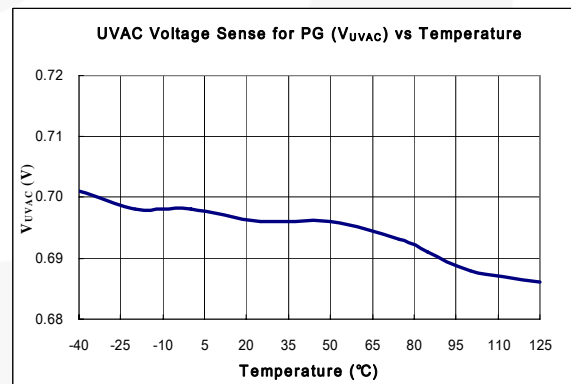
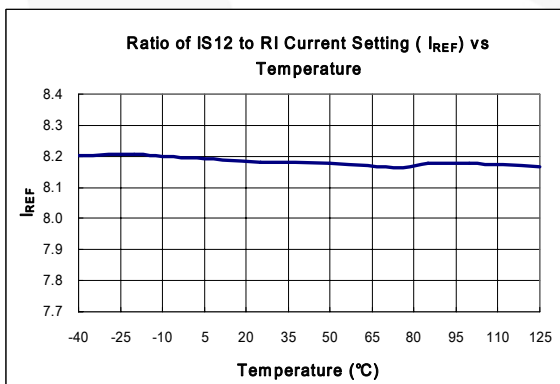
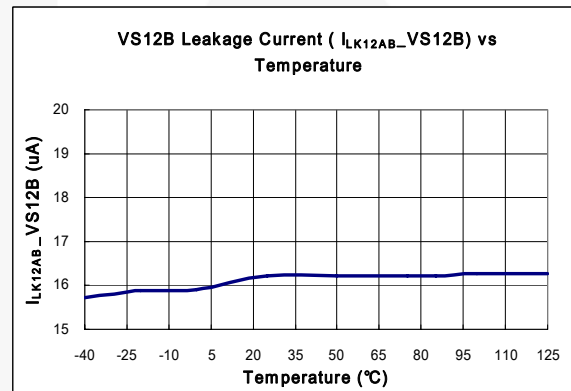
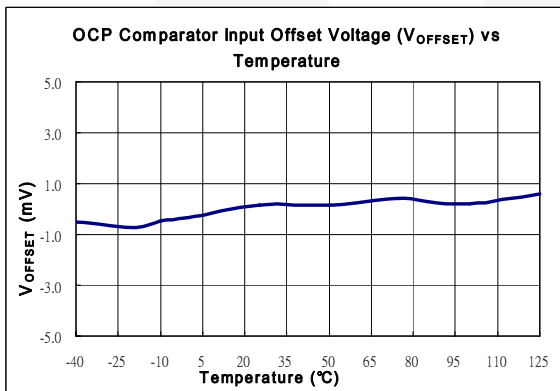
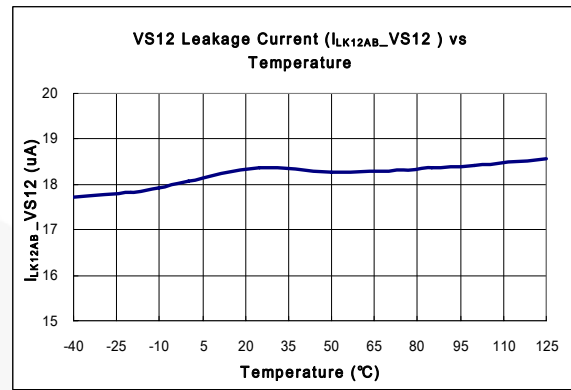
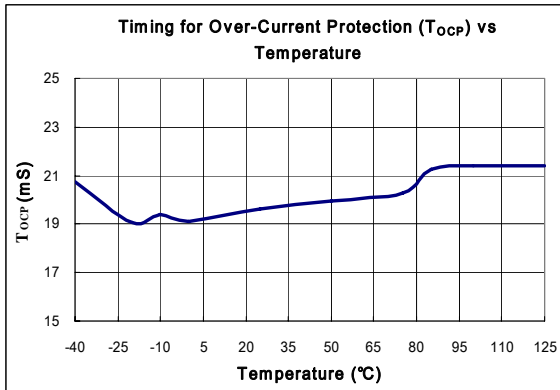

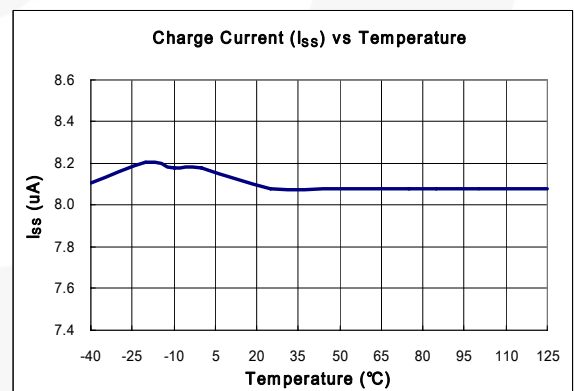
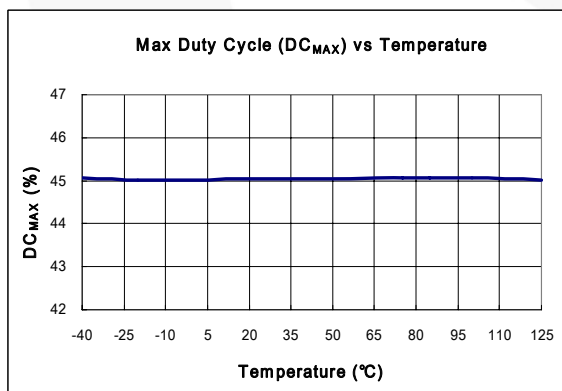
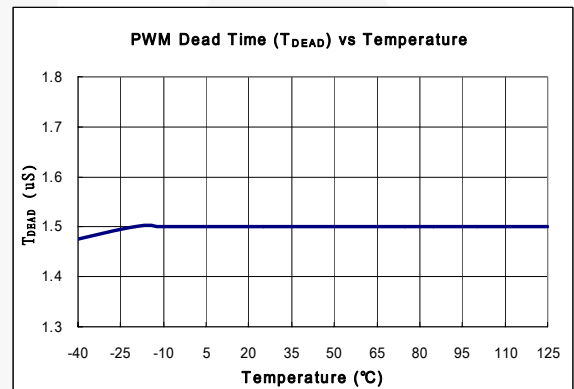
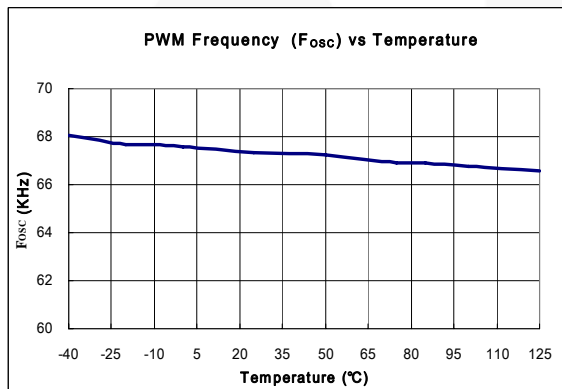
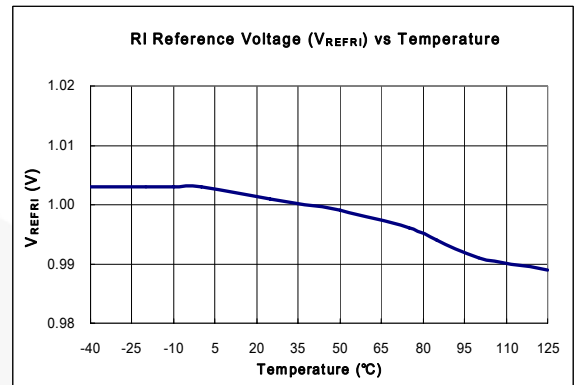
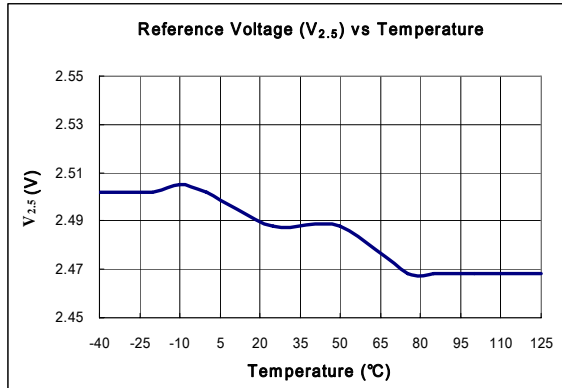

Operation description

Protection against over-voltage, short-circuit and fault conditions is mandatory for PC power supplies. Many commonly used protection circuits require large numbers of discrete components and comparators which occupy significant PCB space and add to assembly costs. This single chip controller IC provides complete protection, shunt regulation, and PWM control with comparatively few components. The SG6108 is an ideal controller IC for PC switching mode power supplies. The features and benefits of this device are listed on the first page.

Feature Notes

- Over voltage protection can be implemented without any additional components. Over-voltage sense levels are 3.3V/5V/12V or 4.1V/6.1V/14.05V.
- The SG6108's over current protection monitors the 3.3V, 5V, and the two 12V levels. The voltage difference across the external current shunt is used to provide accurate OCP.
- Over current and/or short circuit protection can also be implemented by using over-power protection. To do this, the OPP pin must be connected to the current transformer (driver transformer).
- The power good signal is asserted to indicate that the 3.3V/5V/12V signals are above the under voltage threshold level. The PG pin goes high when the above condition is reached. A 2kΩ pull up resistor may be optionally connected to the 5V lead.
- VCC can be supplied from the 5V-standby. Whenever the VCC voltage exceeds 7V the entire SG6108 will be shutdown and reset (except for the shunt regulator). No extra power supply is needed.
- Complete PWM control circuitry includes an error amplifier for push-pull or half-bridge operation.

Supervisory Circuit Operation

The PC generates the remote ON/OFF logic (PSON) signal. When this is "Low" the power supply is "On". When it is "High", the power supply is switched off. The remote ON/OFF signal is supplied to the PSON input.

Application Guides

The application guide shows the key features of the SG6108 and illustrates how to use it in an ATX switching mode power supply (SMPS). The SG6108 is suitable for half-bridge, push-pull topologies. The PWM section of the SG6108 comprises a built-in 65kHz oscillator and high immunity circuits, which protect the system from noise interference and provide higher noise margins against improper PCB layout. The SG6108 has OVP, UVP, and OCP for the 3.3V and 5V signals, as well as both 12V signals. NVP is used for negative voltage protection (-12V/-5V). UVAC (AC failure detection) is used to measure the AC line voltage.

AC Failure Detection

UVAC is connected to the secondary power transformer through a resistor divider. UVAC is used for detecting the AC line voltage. Whenever the UVAC voltage drops below 0.7V for a period of time such as 150usec, the PG (power good) signal will be pulled low to indicate an AC line power-down condition.

The voltage amplitude of the PWM switching signal in the secondary power transformer is proportional to the AC line voltage. The power-down warning threshold can be controlled by adjusting the resistor-divider ratio. A small

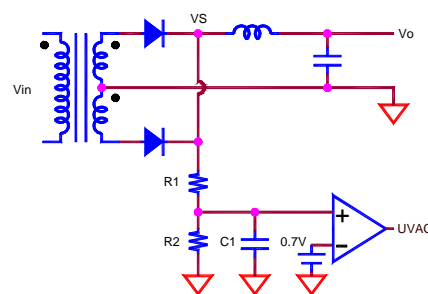

capacitor must be connected between UVAC and ground to filter the switching noise.

Over Power Protection (OPP)

OPP (over power protection) is used to detect over power and short-circuit conditions. Whenever the V_{OPP} voltage (p.7, Note-1) exceeds 2.3V for longer than 6msec the SG6108 will pull PG low and lock off the power outputs.

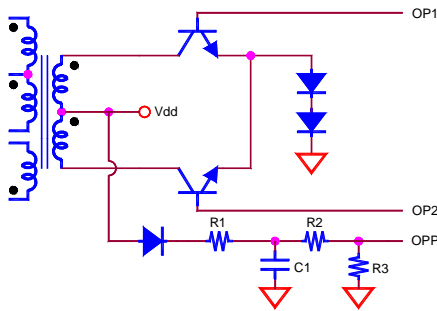

Negative Voltage Protection

NVP provides UVP (under voltage protection) for negative voltage outputs. An under-voltage condition indicates an overload at a negative voltage output. For example, the -12V output may drop to -10V during overload situations. The resistance of a resistor connected from NVP to the negative voltage output determines the protection threshold voltage. NVP outputs a 64uA constant current to the negative voltage output via this resistor. Whenever the NVP voltage exceeds 2.1V for longer than 7 msec the SG6108 will lock the power outputs off.

$$VNVP = 64 \mu A \times (R1 + R2) - V-12V$$

The power outputs will be locked off when $VNVP \geq 2.1V$.

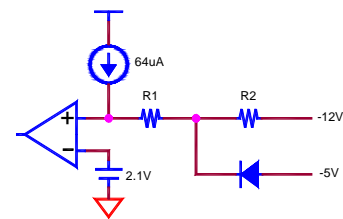

Over Current Protection (OCP)

The SG6108 provides over current protection for the 3.3V, 5V and the two 12V rails. Whenever an OCP condition occurs at any of the voltage rails, PG will be low and PWM will be turned off. The internal OCP comparators have a very small offset voltage ($\pm 5mV$).

The sink currents of IS33, IS5, and IS12 are 8 times the current at the RI pin. The current at the RI pin is V_{RI}/R_I . Here is an example demonstrating how to set the over current protection threshold:

$$I_{RI} = V_{RI}/R_I = 1.0V/75k = 13.3\mu A$$

If $R1 = 1700\Omega$ and $R12 = 0.01\Omega$, then

$$OC P = 13.3\mu A \times 8 \times 1700 / 0.01 = 18 A$$

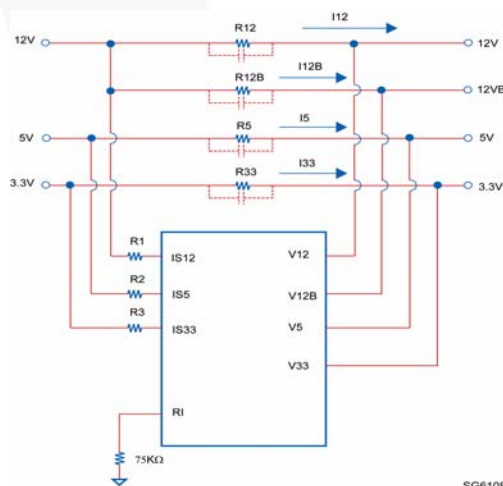

REFERENCE CIRCUIT

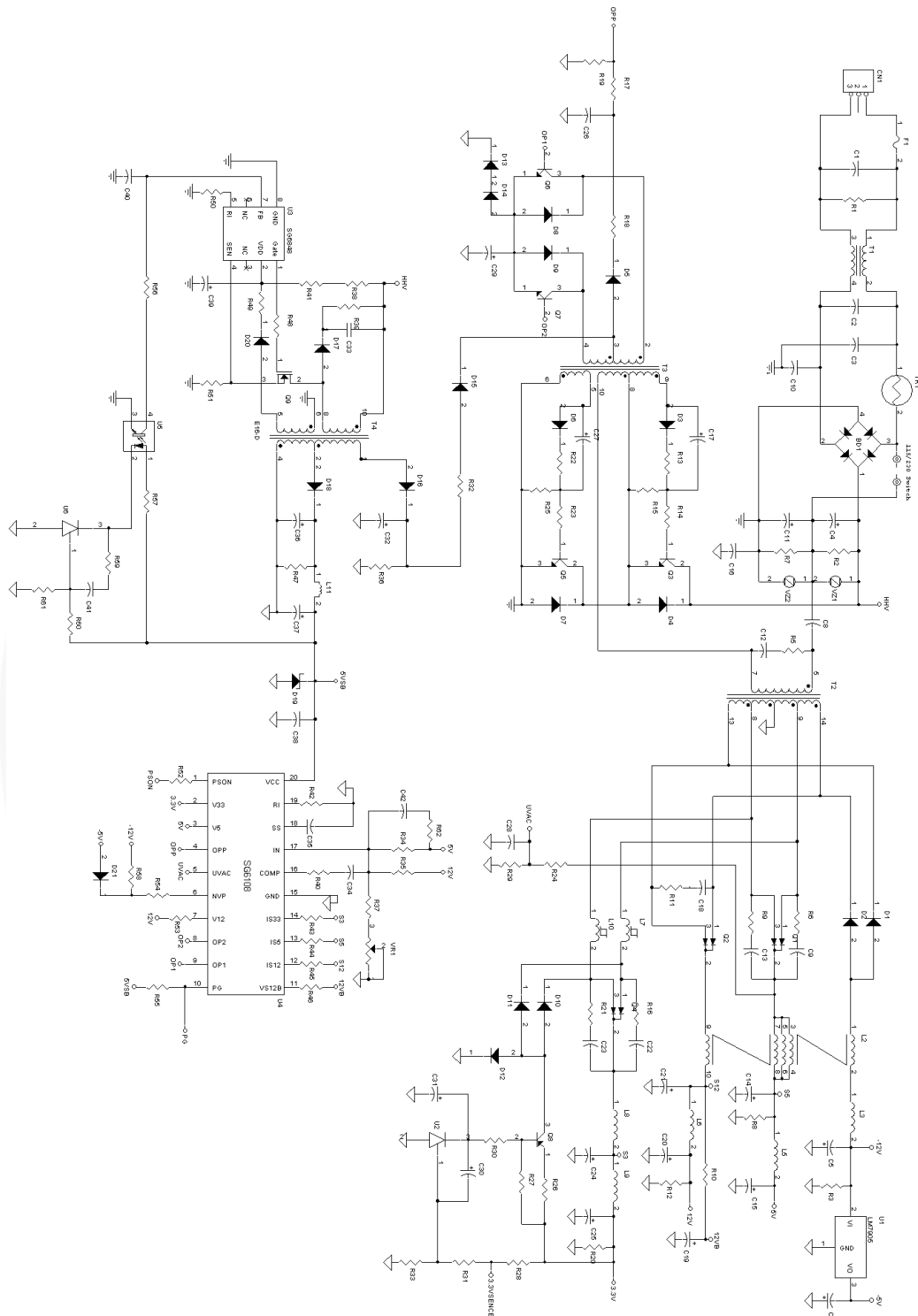

PACKAGE INFORMATION

20 PINS – DIP (D)

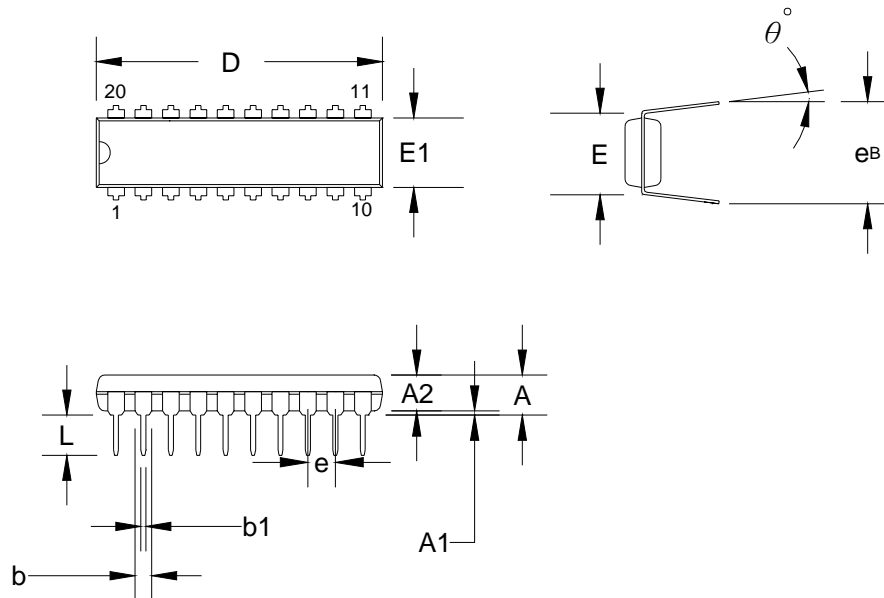

Dimensions

Symbol	Millimeters			Inches		
	Min.	Typ.	Max.	Min.	Typ.	Max.
A			5.334			0.210
A1	0.381			0.015		
A2	3.175	3.302	3.429	0.125	0.130	0.135
b		1.524			0.060	
b1		0.457			0.018	
D	24.892	26.162	26.924	0.980	1.030	1.060
E		7.620			0.300	
E1	6.223	6.350	6.477	0.245	0.250	0.255
e		2.540			0.100	
L	2.921	3.302	3.810	0.115	0.130	0.150
e _B	8.509	9.017	9.525	0.335	0.355	0.375
θ°	0°	7°	15°	0°	7°	15°



TRADEMARKS

The following are registered and unregistered trademarks and service marks Fairchild Semiconductor owns or is authorized to use and is not intended to be an exhaustive list of all such trademarks.

- | | | | |
|--------------------------------------|---|--|----------------------------------|
| ACEx [®] | Green FPS [™] | Power247 [®] | SuperSOT [™] -8 |
| Build it Now [™] | Green FPS [™] e-Series [™] | POWEREDGE [®] | SyncFET [™] |
| CorePLUS [™] | GTO [™] | Power-SPM [™] | The Power Franchise [®] |
| CROSSVOLT [™] | i-Lo [™] | PowerTrench [®] | the power franchise |
| CTL [™] | IntelliMAX [™] | Programmable Active Droop [™] | TinyBoost [™] |
| Current Transfer Logic [™] | ISOPLANAR [™] | QFET [®] | TinyBuck [™] |
| EcoSPARK [®] | MegaBuck [™] | QS [™] | TinyLogic [®] |
| F [®] | MICROCOUPLER [™] | QT Optoelectronics [™] | TINYOPTO [™] |
| Fairchild [®] | MicroFET [™] | Quiet Series [™] | TinyPower [™] |
| Fairchild Semiconductor [®] | MicroPak [™] | RapidConfigure [™] | TinyPWM [™] |
| FACT Quiet Series [™] | MillerDrive [™] | SMART START [™] | TinyWire [™] |
| FACT [®] | Motion-SPM [™] | SPM [®] | μSerDes [™] |
| FAST [®] | OPTOLOGIC [®] | STEALTH [™] | UHC [®] |
| FastvCore [™] | OPTOPLANAR [®] | SuperFET [™] | UniFET [™] |
| FPST [™] |  | SuperSOT [™] -3 | VCX [™] |
| FRFET [®] | PDP-SPM [™] | SuperSOT [™] -6 | |
| Global Power Resource SM | Power220 [®] | | |

DISCLAIMER

FAIRCHILD SEMICONDUCTOR RESERVES THE RIGHT TO MAKE CHANGES WITHOUT FURTHER NOTICE TO ANY PRODUCTS HEREIN TO IMPROVE RELIABILITY, FUNCTION, OR DESIGN. FAIRCHILD DOES NOT ASSUME ANY LIABILITY ARISING OUT OF THE APPLICATION OR USE OF ANY PRODUCT OR CIRCUIT DESCRIBED HEREIN; NEITHER DOES IT CONVEY ANY LICENSE UNDER ITS PATENT RIGHTS, NOR THE RIGHTS OF OTHERS. THESE SPECIFICATIONS DO NOT EXPAND THE TERMS OF FAIRCHILD'S WORLDWIDE TERMS AND CONDITIONS, SPECIFICALLY THE WARRANTY THEREIN, WHICH COVERS THESE PRODUCTS.

LIFE SUPPORT POLICY

FAIRCHILD'S PRODUCTS ARE NOT AUTHORIZED FOR USE AS CRITICAL COMPONENTS IN LIFE SUPPORT DEVICES OR SYSTEMS WITHOUT THE EXPRESS WRITTEN APPROVAL OF FAIRCHILD SEMICONDUCTOR CORPORATION.

As used herein:

1. Life support devices or systems are devices or systems which, (a) are intended for surgical implant into the body or (b) support or sustain life, and (c) whose failure to perform when properly used in accordance with instructions for use provided in the labeling, can be reasonably expected to result in a significant injury of the user.
2. A critical component in any component of a life support device, or system whose failure to perform can be reasonably expected to cause the failure of the life support device or system, or to affect its safety or effectiveness.

PRODUCT STATUS DEFINITIONS

Definition of Terms

Datasheet Identification	Product Status	Definition
Advance Information	Formative or In Design	This datasheet contains the design specifications for product development. Specifications may change in any manner without notice.
Preliminary	First Production	This datasheet contains preliminary data; supplementary data will be published at a later date. Fairchild Semiconductor reserves the right to make changes at any time without notice to improve design.
No Identification Needed	Full Production	This datasheet contains final specifications. Fairchild Semiconductor reserves the right to make changes at any time without notice to improve design.
Obsolete	Not In Production	This datasheet contains specifications on a product that has been discontinued by Fairchild Semiconductor. The datasheet is printed for reference information only.