

defining a degree of excellence



ISOLATION TRANSFORMERS FOR ETHERNET

960035A

- Bel isolation transformers are designed to be used as equipment isolation protection for the cable-AUI interface in 10Base-2, 10Base-5 and 10Base-T applications
- Multiple OCL (inductance) values available
- Turns ratio 1:1
- 2000 Vrms isolation
- Through-hole and surface mount packaging

ELECTRICALS AT 25°C

Part No.	Inductance OCL (μH) (+/- 20)	ET Constant (Vμs) Min	Rise Time (ns) Max	Coupling Capacitance C _{ww} (pF) Max	Leakage Inductance L _L (μH) Max	Pri/Sec (ohms) Max	Schematic	Package Style
A553-0756-AB	75	2.1	3.0	10	0.20	0.20/0.20	A	1
A553-1006-AB	100	2.1	3.0	10	0.20	0.20/0.20	A	1
A553-1506-AB	150	3.0	3.5	12	0.25	0.30/0.30	A	1
S553-0506-AE	50	1.0	1.8	5	0.10	0.15/0.15	A	2
S553-0745-01	350	1.5	3.5	16	0.30	0.35/0.35	A	2
S553-0756-AE	75	1.4	1.8	7	0.10	0.17/0.17	A	2
S553-1006-AE	100	1.5	1.8	8	0.10	0.20/0.20	A	2
S553-1506-AE	150	1.8	1.8	9	0.10	0.20/0.20	A	2
S553-5999-67	75	1.4	1.8	7.0	0.10	0.17/0.17	A	3
S553-5999-68	150	1.8	1.8	9.0	0.10	0.20/0.20	A	3
S553-5999-69	100	1.5	1.8	8.0	0.10	0.20/0.20	A	3
S553-5999-72	100	1.5	1.8	8.0	0.10	0.20/0.20	B	4
S553-5999-73	150	1.8	1.8	9.0	0.10	0.20/0.20	B	4
S553-5999-74	75	1.4	1.8	7.0	0.10	0.17/0.17	B	4

SCHEMATICS

A

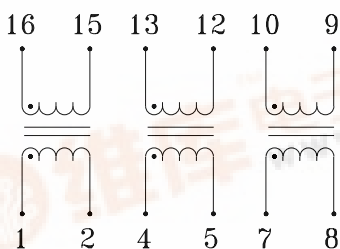

B

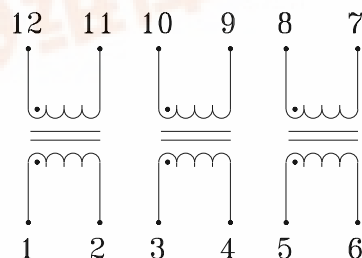

Specifications subject to change without notice.



defining a degree of excellence

ISOLATION TRANSFORMERS FOR ETHERNET

960035A

MECHANICALS

1

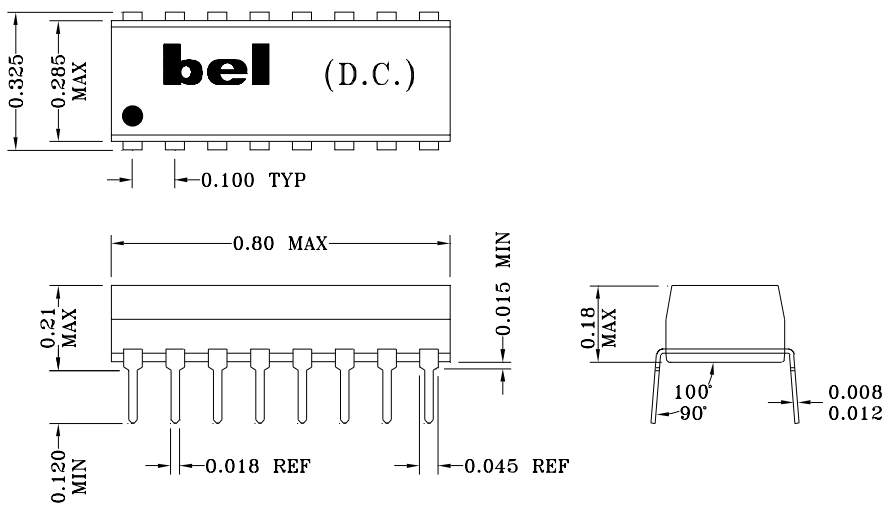

2

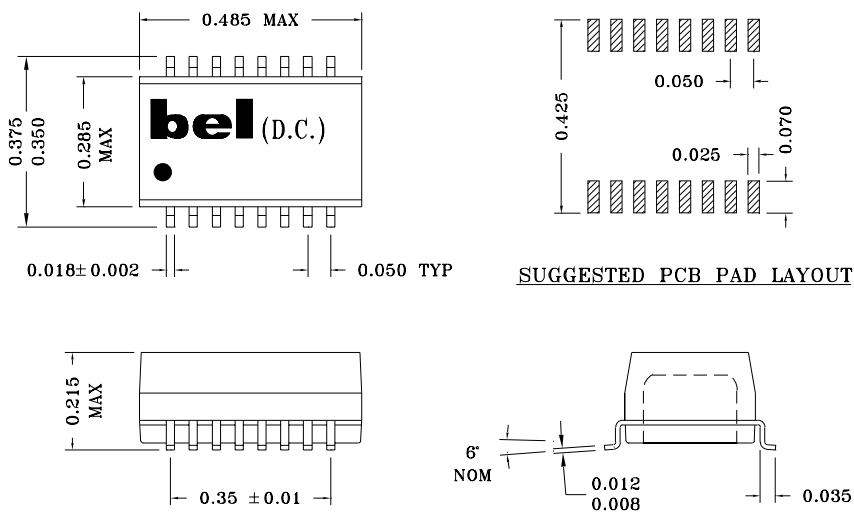

Specifications subject to change without notice.

**ISOLATION TRANSFORMERS
FOR ETHERNET**

960035A

MECHANICALS (CONT'D)

3

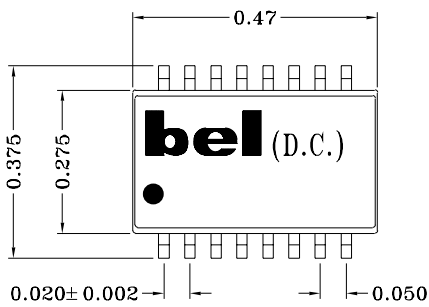

SUGGESTED PCB PAD LAYOUT

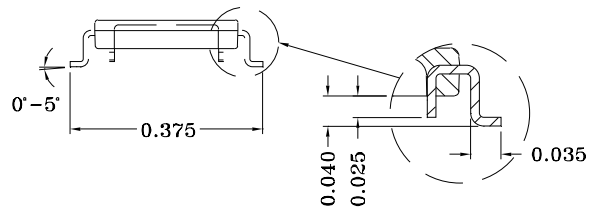
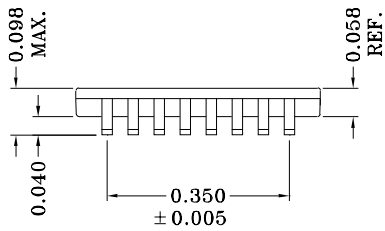
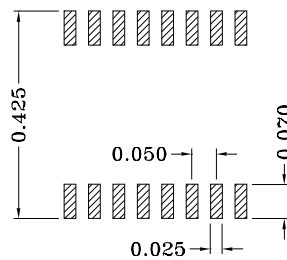

4

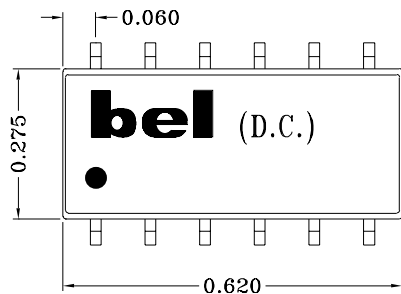

SUGGESTED PCB PAD LAYOUT

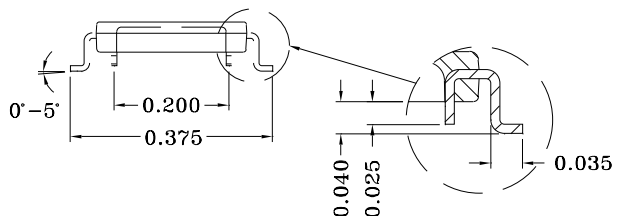
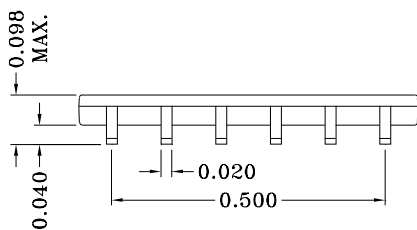
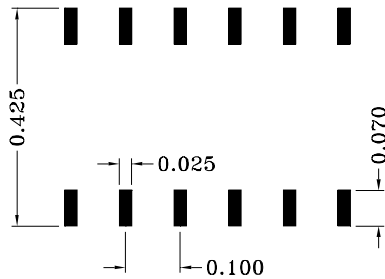

Specifications subject to change without notice.



defining a degree of excellence

ISOLATION TRANSFORMERS FOR ETHERNET

960035A

APPLICATION CIRCUIT

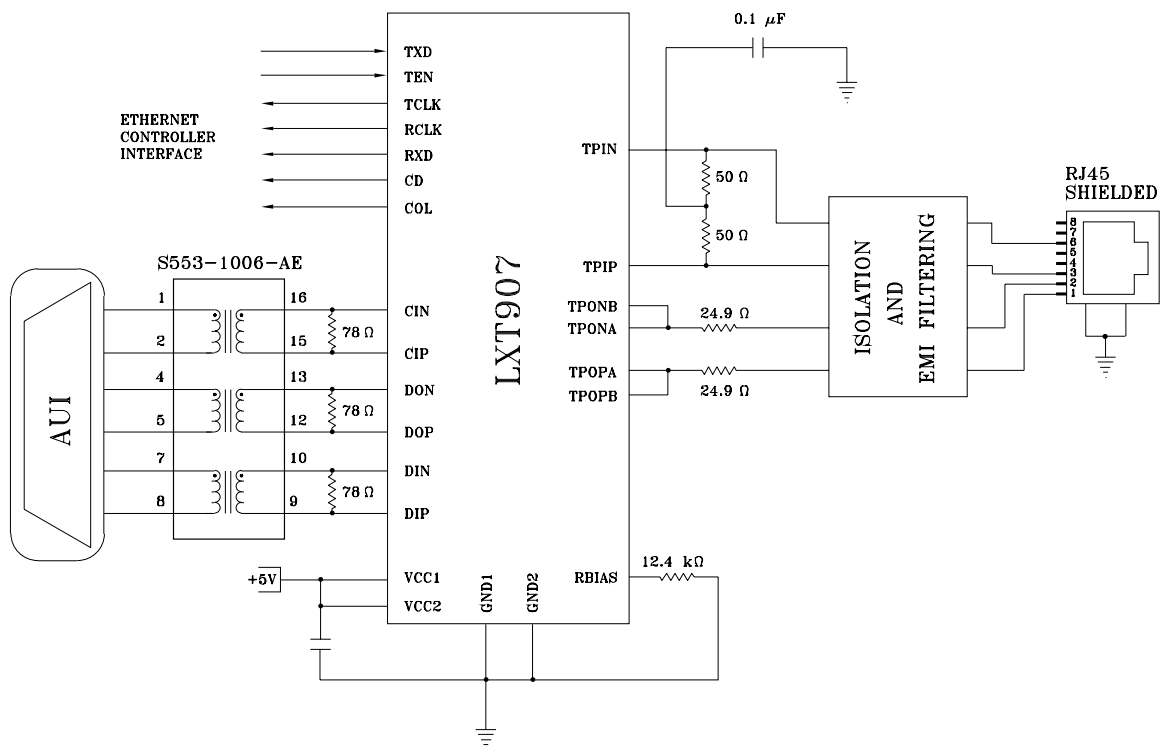

APPLICATION NOTES

- Bel transformers for Ethernet AUI applications provide the necessary isolation and inductance as required in the IEEE 802.3 standards for AUI (Attachment Unit Interface) ports.