



REALTEK

RTL8168

INTEGRATED GIGABIT ETHERNET CONTROLLER FOR PCI EXPRESS™ APPLICATIONS

DATASHEET

Rev. 1.1
05 November 2004
Track ID: JATR-1076-21



REALTEK

Realtek Semiconductor Corp.

No. 2, Industry E. Rd. IX, Science-Based Industrial Park, Hsinchu 300, Taiwan

Tel: +886-3-5780211 Fax: +886-3-5776047

www.realtek.com.tw

COPYRIGHT

©2004 Realtek Semiconductor Corp. All rights reserved. No part of this document may be reproduced, transmitted, transcribed, stored in a retrieval system, or translated into any language in any form or by any means without the written permission of Realtek Semiconductor Corp.

DISCLAIMER

Realtek provides this document “as is”, without warranty of any kind, neither expressed nor implied, including, but not limited to, the particular purpose. Realtek may make improvements and/or changes in this document or in the product described in this document at any time. This document could include technical inaccuracies or typographical errors.

TRADEMARKS

Realtek is a trademark of Realtek Semiconductor Corporation. Other names mentioned in this document are trademarks/registered trademarks of their respective owners.

USING THIS DOCUMENT

This document is intended for the software engineer’s reference and provides detailed programming information.

Though every effort has been made to ensure that this document is current and accurate, more information may have become available subsequent to the production of this guide. In that event, please contact your Realtek representative for additional information that may help in the development process.

REVISION HISTORY

Revision	Release Date	Summary
1.0	2004/08/31	First release.
1.1	2004/11/05	Package changes. See section 8, Mechanical Dimensions, page 26, and section 9, Ordering Information, page 27.

Table of Contents

1. GENERAL DESCRIPTION	1
2. FEATURES	2
3. SYSTEM APPLICATIONS	2
4. PIN ASSIGNMENTS	3
5. PIN DESCRIPTIONS	4
5.1. POWER MANAGEMENT/ISOLATION	4
5.2. PCI EXPRESS INTERFACE.....	4
5.3. EEPROM/BROM	5
5.4. TRANSCEIVER INTERFACE.....	5
5.5. CLOCK.....	6
5.6. REGULATOR & REFERENCE.....	6
5.7. LEDs.....	6
5.8. POWER & GROUND.....	7
5.9. NC (NOT CONNECTED) PINS.....	7
6. FUNCTIONAL DESCRIPTION	8
6.1. PCI EXPRESS BUS INTERFACE.....	8
6.1.1. <i>PCI Express Transmitter</i>	8
6.1.2. <i>PCI Express Receiver</i>	8
6.2. LED FUNCTIONS	8
6.2.1. <i>Link Monitor</i>	8
6.2.2. <i>Rx LED</i>	9
6.2.3. <i>Tx LED</i>	10
6.2.4. <i>Tx/Rx LED</i>	11
6.2.5. <i>LINK/ACT LED</i>	12
6.3. PHY TRANSCEIVER.....	13
6.3.1. <i>PHY Transmitter</i>	13
6.3.2. <i>PHY Receiver</i>	13
6.4. NEXT PAGE.....	14
6.5. EEPROM INTERFACE	14
6.6. POWER MANAGEMENT	15
6.7. VITAL PRODUCT DATA (VPD).....	17
7. CHARACTERISTICS	18
7.1. ABSOLUTE MAXIMUM RATINGS	18
7.2. RECOMMENDED OPERATING CONDITIONS.....	18
7.3. CRYSTAL REQUIREMENTS.....	18
7.4. THERMAL CHARACTERISTICS	19
7.5. DC CHARACTERISTICS	19
7.6. AC CHARACTERISTICS	20
7.6.1. <i>Serial EEPROM Interface Timing</i>	20



7.7.	BOOT ROM TIMING	21
7.7.1.	<i>BOOT ROM - Read</i>	21
7.8.	PCI EXPRESS BUS PARAMETERS	22
7.8.1.	<i>Differential Transmitter Parameters</i>	22
7.8.2.	<i>Differential Receiver Parameters</i>	23
7.8.3.	<i>REFCLK Parameters</i>	23
7.8.4.	<i>Auxiliary Signal Timing Parameters</i>	25
8.	MECHANICAL DIMENSIONS	26
8.1.	MECHANICAL DIMENSIONS NOTES	27
9.	ORDERING INFORMATION	27



List of Tables

Table 1.	Power Management/Isolation.....	4
Table 2.	PCI Express Interface.....	4
Table 3.	EEPROM/BROM.....	5
Table 4.	Transceiver Interface.....	5
Table 5.	Clock.....	6
Table 6.	Regulator & Reference.....	6
Table 7.	LEDs.....	6
Table 8.	Power & Ground.....	7
Table 9.	NC (Not Connected) Pins.....	7
Table 10.	EEPROM Interface.....	14
Table 11.	Absolute Maximum Ratings.....	18
Table 12.	Recommended Operating Conditions.....	18
Table 13.	Crystal Requirements.....	18
Table 14.	Thermal Characteristics.....	19
Table 15.	DC Characteristics.....	19
Table 16.	EEPROM Access Timing Parameters.....	20
Table 17.	BOOT ROM - Read.....	21
Table 18.	Differential Transmitter Parameters.....	22
Table 19.	Differential Receiver Parameters.....	23
Table 20.	REFCLK Parameters.....	23
Table 21.	Auxiliary Signal Timing Parameters.....	25
Table 22.	Ordering Information.....	27

List of Figures

Figure 1.	Pin Assignments.....	3
Figure 2.	Rx LED.....	9
Figure 3.	Tx LED.....	10
Figure 4.	Tx/Rx LED.....	11
Figure 5.	LINK/ACT LED.....	12
Figure 6.	Serial EEPROM Interface Timing.....	20
Figure 7.	BOOT ROM - Read.....	21
Figure 8.	REFCLK Single-Ended Measurement Points for T_{rise} and T_{fall}	24
Figure 9.	REFCLK Single-Ended Measurement Points for V_{ovs} , V_{uds} , and V_{rb}	24
Figure 10.	REFCLK Differential Measurement Points for T_{period} , Duty Cycle, and Jitter.....	24
Figure 11.	REFCLK V_{cross} Range.....	25
Figure 12.	Auxiliary Signal Timing.....	25

1. General Description

The Realtek RTL8168 Gigabit Ethernet controller combines a triple-speed IEEE 802.3 compliant Media Access Controller (MAC) with a triple-speed Ethernet transceiver, PCI Express bus controller, and embedded memory. With state-of-the-art DSP technology and mixed-mode signal technology, they offer high-speed transmission over CAT 5 UTP cable or CAT 3 UTP (10Mbps only) cable. Functions such as Crossover Detection & Auto-Correction, polarity correction, adaptive equalization, cross-talk cancellation, echo cancellation, timing recovery, and error correction are implemented to provide robust transmission and reception capability at high speeds.

The device supports the PCI Express 1.0a bus interface for host communications with power management and is compliant with the IEEE 802.3u specification for 10/100Mbps Ethernet and the IEEE 802.3ab specification for 1000Mbps Ethernet. It also supports an auxiliary power auto-detect function, and will auto-configure related bits of the PCI power management registers in PCI configuration space.

Advanced Configuration Power management Interface (ACPI)--power management for modern operating systems that are capable of Operating System-directed Power Management (OSPM)—is also supported to achieve the most efficient power management possible. PCI Message Signaled Interrupt (MSI) is also supported.

In addition to the ACPI feature, remote wake-up (including AMD Magic Packet™, Re-LinkOk, and Microsoft® Wake-up frame) is supported in both ACPI and APM (Advanced Power Management) environments. To support WOL from a deep power down state (e.g., D3cold, i.e. main power is off and only auxiliary exists), the auxiliary power source must be able to provide the needed power for the RTL8168.

The RTL8168 is fully compliant with Microsoft® NDIS5 (IP, TCP, UDP) Checksum and Segmentation Task-offload features, and supports IEEE 802 IP Layer 2 priority encoding and 802.1Q Virtual bridged Local Area Network (VLAN). The above features contribute to lowering CPU utilization, especially benefiting performance when in operation on a network server.

The device features next-generation PCI Express interconnect technology. PCI Express is a high-bandwidth, low pin count, serial, interconnect technology that offers significant improvements in performance over conventional PCI and also maintains software compatibility with existing PCI infrastructure.

The RTL8168 is suitable for multiple market segments and emerging applications, such as desktop, mobile, workstation, server, communications platforms, and embedded applications.

2. Features

- Integrated 10/100/1000 transceiver
- Auto-Negotiation with Next Page capability
- Supports PCI Express™ 1.0a
- Supports pair swap/polarity/skew correction
- Crossover Detection & Auto-Correction
- Wake-on-LAN and remote wake-up support
- Microsoft® NDIS5 Checksum Offload (IP, TCP, UDP) and Largesend Offload support
- Supports Full Duplex flow control (IEEE 802.3x)
- Fully compliant with IEEE 802.3, IEEE 802.3u, IEEE 802.3ab
- Supports IEEE 802.1P Layer 2 Priority Encoding
- Supports IEEE 802.1Q VLAN tagging
- Serial EEPROM
- Transmit/Receive on-chip buffer (8KB/16KB) support
- Supports power down/link down power saving
- Supports PCI Message Signaled Interrupt (MSI)
- 128-pin DHS-QFP package

3. System Applications

- PCI Express™ Gigabit Ethernet adapter

5. Pin Descriptions

The signal type codes below are used in the following tables:

I:	Input	S/T/S:	Sustained Tri-State
O:	Output	O/D:	Open Drain
T/S:	Tri-State bi-directional input/output pin		

5.1. Power Management/Isolation

Table 1. Power Management/Isolation

Symbol	Type	Pin No	Description
LANWAKEB	O/D	36	Power Management Event: Open drain, active low. Used to reactivate the PCI Express slot's main power rails and reference clocks.
ISOLATEB	I	71	Isolate Pin: Active low. Used to isolate the RTL8168 from the PCI Express bus. The RTL8168 will not drive its PCI Express outputs (excluding LANWAKEB) and will not sample its PCI Express input as long as the Isolate pin is asserted.

5.2. PCI Express Interface

Table 2. PCI Express Interface

Symbol	Type	Pin No	Description
REFCLK_P	I	50	PCI Express Differential Reference Clock Source: 100MHz ± 300ppm.
REFCLK_N	I	51	
HSOP	O	54	PCI Express Transmit Differential Pair.
HSOIN	O	55	
HSIP	I	47	PCI Express Receive Differential Pair.
HSIN	I	48	
PERSTB	I	37	PCI Express Reset Signal: Active low. When the PERSTB is asserted at power-on state, the RTL8168 returns to a pre-defined reset state and is ready for initialization and configuration after the de-assertion of the PERSTB.
ATTNPRS	I	29	PCI Express™ Hot Plug Card Attention Press Button: This input pin is connected to an external push button for user to press to indicate that they would like to hot remove the RTL8168 PCI Express™ Hot Plug NIC card.
PWRIND	O	30	PCI Express™ Hot Plug Card Power Indicator: This output pin is connected to an LED to indicate whether or not the power is already applied to the RTL8168 PCI Express™ Hot Plug NIC card.
ATTNIND	O	31	PCI Express™ Hot Plug Card Attention Indicator: This output pin is connected to an LED to indicate that the RTL8168 PCI Express™ Hot Plug Card Attention Press Button has been pressed if the LED is blinking, and to indicate that the RTL8168 PCI Express™ Hot Plug NIC card has operational problem if the LED is on.

5.3. EEPROM/BROM

Table 3. EEPROM/BROM

Symbol	Type	Pin No	Description
EESK	O	100	Serial data clock.
EEDI/AUX	O/I	99	EEDI: Output to serial data input pin of EEPROM. AUX: Input pin to detect if Aux. Power exists or not on initial power-on. This pin should be connected to EEPROM. To support wakeup from ACPI D3cold or APM power-down, this pin must be pulled high to Aux. Power via a resistor. If this pin is not pulled high to Aux. Power, the RTL8168 assumes that no Aux. Power exists.
EEDO	I	97	Input from serial data output pin of EEPROM.
EECS	O	96	EECS: EEPROM chip select.
ROMCSB	O	111	ROM Chip Select: Active high. Chip select signal to Boot PROM.
ROMOEB	O	113	ROM Output Enable: Active high. Enable the output buffer of Boot PROM.
MD7-0	I	89, 95, 102, 103, 105, 106, 107, 108	Boot PROM Data Bus.
MA16-0	O	88, 83, 82, 81, 78, 77, 75, 70, 69, 68, 67, 66, 65, 63, 62, 61, 60	Boot PROM Address Bus: Support up to 128K bytes EPROM.

5.4. Transceiver Interface

Table 4. Transceiver Interface

Symbol	Type	Pin No	Description
MDIP0	I/O	5	In MDI mode, this is the first pair in 1000Base-T, i.e. the BI_DA+/- pair, and is the transmit pair in 10Base-T and 100Base-TX.
MDIN0	I/O	6	
MDIP1	I/O	9	In MDI mode, this is the second pair in 1000Base-T, i.e. the BI_DB+/- pair, and is the transmit pair in 10Base-T and 100Base-TX.
MDIN1	I/O	10	
MDIP2	I/O	18	In MDI mode, this is the third pair in 1000Base-T, i.e. the BI_DC+/- pair.
MDIN2	I/O	19	
MDIP3	I/O	22	In MDI mode, this is the fourth pair in 1000Base-T, i.e. the BI_DD+/- pair.
MDIN3	I/O	23	

5.5. Clock

Table 5. Clock

Symbol	Type	Pin No	Description
CKXTAL1	I	125	Input of 25MHz clock reference.
CKXTAL2	O	126	Output of 25MHz clock reference.

5.6. Regulator & Reference

Table 6. Regulator & Reference

Symbol	Type	Pin No	Description
VCTRL25	O	12	Regulator Control. Voltage control to external 2.5V power transistor.
VCTRL20	O	15	Regulator Control. Voltage control to external V* power transistor.
VCTRL18	O	1	Regulator Control. Voltage control to external 1.8V power transistor.
RSET	I	3	Reference. External Resistor Reference.

* Please refer to the most updated schematic circuit for correct configuration.

5.7. LEDs

Table 7. LEDs

Symbol	Type	Pin No	Description				
LED0	O	120	LEDS1-0	00	01	10	11
LED1	O	119	LED0	Tx/Rx	LINK10/1000/ ACT	Tx	LINK10/AC T
LED2	O	118					
LED3	O	117	LED1	LINK100	LINK100/100 0/ACT	LINK	LINK100/ ACT
			LED2	LINK10	FULL	Rx	FULL
			LED3	LINK1000	LINK1000	FULL	LINK1000/ ACT

Note 1: During power down mode, the LED signals are logic high.

Note 2: LED_{S1-0}'s initial value comes from the 93C46. If there is no 93C46, the default values = 1, 1.

5.8. Power & Ground

Table 8. Power & Ground

Symbol	Type	Pin No	Description
VDD3	Power	33, 64, 73, 86, 98, 115	Digital 3.3V power supply.
VDD1	Power	27, 39, 40, 42, 59, 74, 79, 87, 91, 94, 104, 110, 121	Digital 1.8V power supply.
V0VDD	Power	7, 11, 20, 24	Analog 2.5V power supply for GPHY.
VDD20	Power	16	Analog power V* supply for GPHY
VDD1A	Power	46, 52, 53	Analog power V* supply for PCI-E PHY
LV2VDD	Power	128	Analog power V* supply for GPHY
HV1VDD	Power	14, 124	Analog 3
VSS3	Power	25, 43, 58, 72, 84, 93, 122	Digital Ground (3.3V)
VSS1	Power	26, 28, 32, 38, 41, 44, 57, 80, 85, 90, 92, 101, 109, 116, 123	Digital Ground (1.8V)
VSS1A	Power	49, 56	Analog PCI-E Ground.
G0GND	Power	4, 8, 17, 21	Analog Ground (2.5V)
LGGND	Power	2	Analog Ground*
HGIGND	Power	13, 127	Analog Ground (3.3V)

* Please refer to the most updated schematic circuit for correct configuration.

5.9. NC (Not Connected) Pins

Table 9. NC (Not Connected) Pins

Symbol	Type	Pin No	Description
NC		34, 35, 45, 76, 112, 114	Not Connected.

6. Functional Description

6.1. *PCI Express Bus Interface*

The RTL8168 is compliant with PCI Express Base Specification Revision 1.0a, and runs at a 2.5GHz signaling rate with X1 link width, i.e., one transmit and one receive differential pair. The RTL8168 supports four types of PCI Express messages: interrupt messages, error messages, power management messages, and hot-plug messages. The PCI Express lane polarity reversal and link reversal are also supported to ease PCB layout constraints.

6.1.1. PCI Express Transmitter

The RTL8168's PCI Express block receives digital data from the Ethernet interface and performs data scrambling with Linear Feedback Shift Register (LFSR) and 8B/10B coding technology into 10-bit code groups. Data scrambling is used to reduce the possibility of electrical resonance on the link, and 8B/10B coding technology is used to benefit embedded clocking, error detection, and DC balance by sacrificing a 25 percent overhead to the system through the addition of 2 extra bits. The data code groups are passed through its serializer for packet framing. The generated 2.5Gbps serial data is transmitted onto the PCB trace to its upstream device via a differential driver.

6.1.2. PCI Express Receiver

The RTL8168's PCI Express block receives 2.5Gbps serial data from its upstream device to generate parallel data. The receiver's PLL circuits are resynchronized to maintain bit and symbol lock. Through 8B/10B decoding technology and data descrambling, the original digital data is recovered and passed to the RTL8168's internal Ethernet MAC to be transmitted onto the Ethernet media.

6.2. *LED Functions*

The RTL8168 supports 4 LED signals in 4 different configurable operation modes. The following sections describe the various LED actions.

6.2.1. Link Monitor

The Link Monitor senses link integrity, such as LINK10, LINK100, LINK1000, LINK10/100/1000, LINK10/ACT, LINK100/ACT, or LINK1000/ACT. Whenever link status is established, the specific link LED pin is driven low. Once a cable is disconnected, the link LED pin is driven high, indicating that no network connection exists.

6.2.2. Rx LED

In 10/100/1000Mbps mode, blinking of the Rx LED indicates that receive activity is occurring.

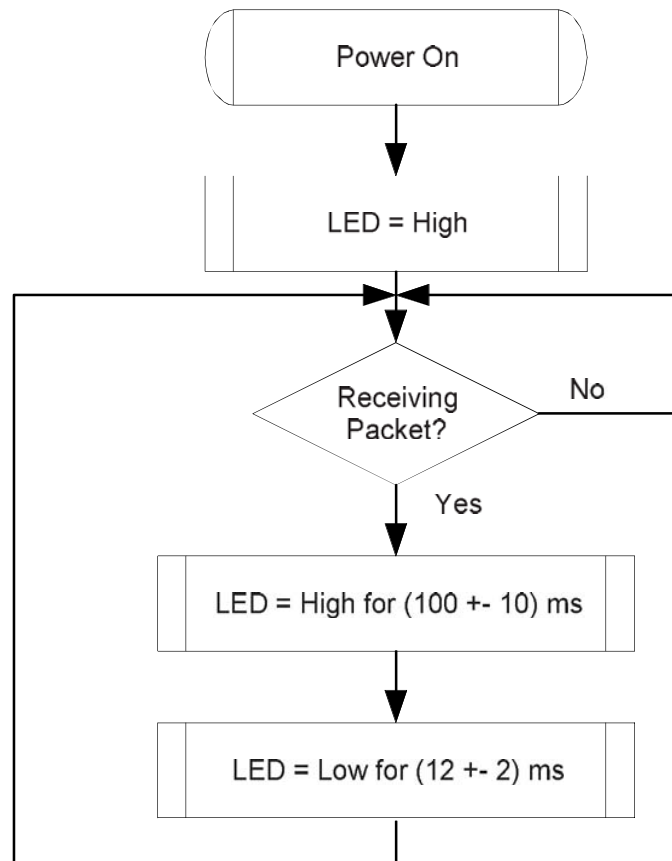

Figure 2. Rx LED

6.2.3. Tx LED

In 10/100/1000Mbps mode, blinking of the Tx LED indicates that transmit activity is occurring.

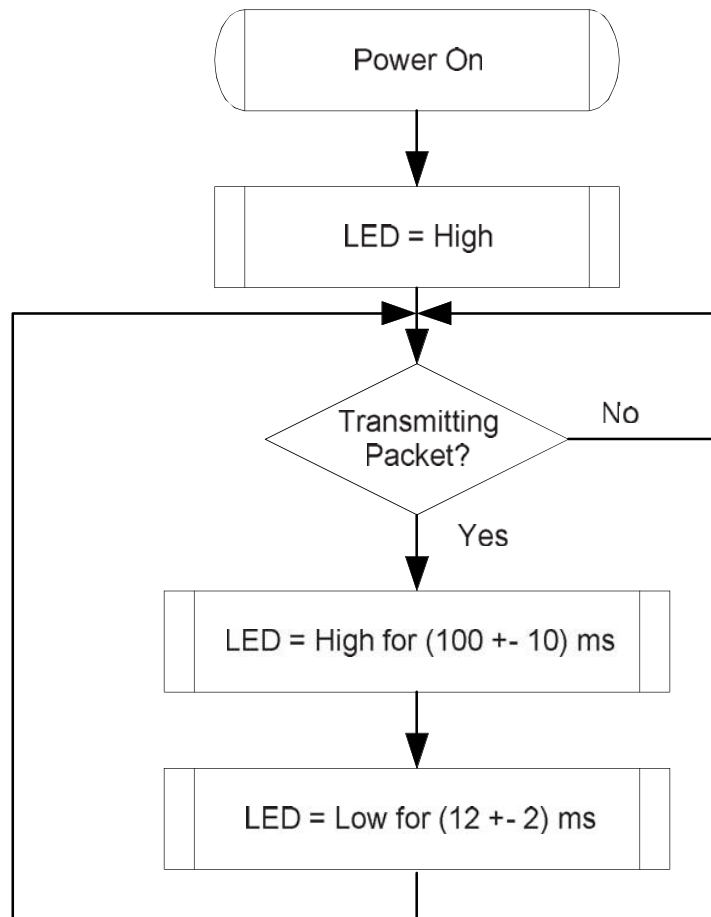

Figure 3. Tx LED

6.2.4. Tx/Rx LED

In 10/100/1000Mbps mode, blinking of the Tx/Rx LED indicates that both transmit and receive activity is occurring.

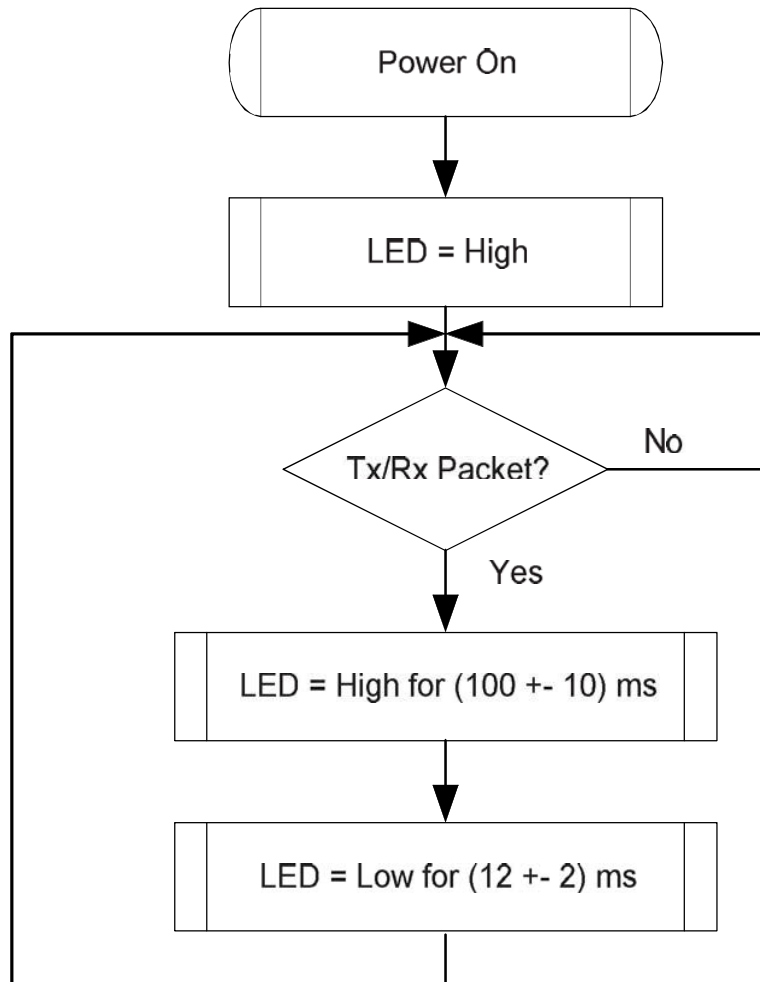

Figure 4. Tx/Rx LED

6.2.5. LINK/ACT LED

In 10/100/1000Mbps mode, blinking of the LINK/ACT LED indicates that the RTL8168 is linked and operating properly. When this LED is high for extended periods, it indicates that a link problem exists.

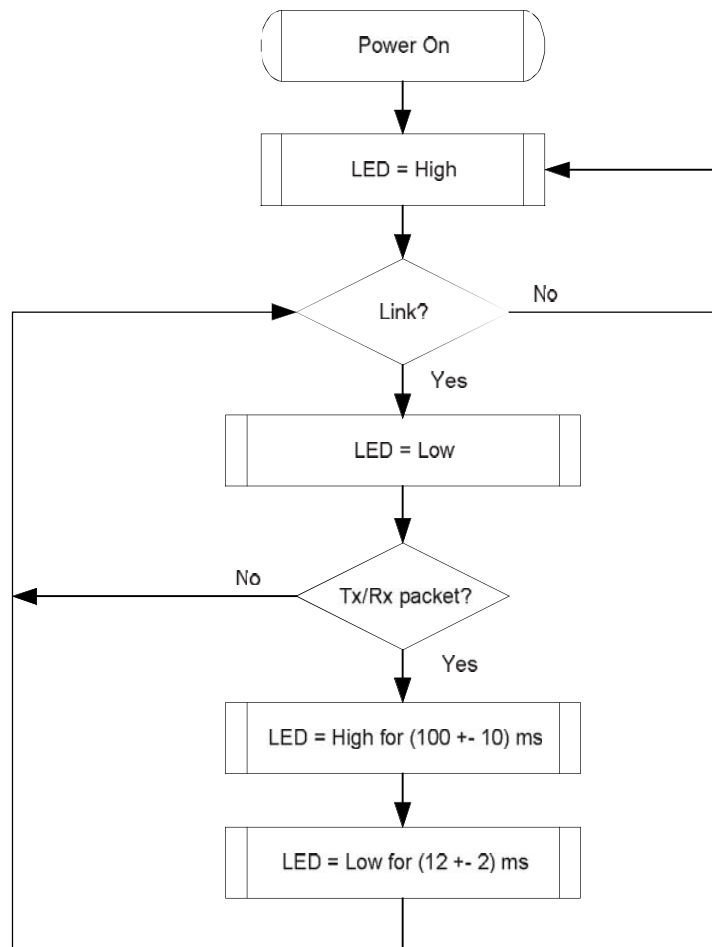

Figure 5. LINK/ACT LED

6.3. *PHY Transceiver*

6.3.1. **PHY Transmitter**

Based on state-of-the-art DSP technology and mixed-mode signal processing technology, the RTL8168 operates at 10/100/1000Mbps over standard CAT.5 UTP cable (100/1000Mbps), and CAT.3 UTP cable (10Mbps).

GMII (1000Mbps) Mode

The RTL8168's PCS layer receives data bytes from the MAC through the GMII interface and performs the generation of continuous code-groups through 4D-PAM5 coding technology. These code groups are passed through a waveform-shaping filter to minimize EMI effect, and are transmitted onto the 4-pair CAT5 cable at 125MBaud/s through a D/A converter.

MII (100Mbps) Mode

The transmitted 4-bit nibbles (TXD[3:0]) from the MAC, clocked at 25MHz (TXC), are converted into 5B symbol code through 4B/5B coding technology, then through scrambling and serializing, are converted to 125Mhz NRZ and NRZI signals. After that, the NRZI signals are passed to the MLT3 encoder, then to the D/A converter and transmitted onto the media.

MII (10Mbps) Mode

The transmitted 4-bit nibbles (TXD[3:0]) from the MAC, clocked at 2.5MHz (TXC), are serialized into 10Mbps serial data. Then, the 10Mbps serial data is converted into a Manchester-encoded data stream and is transmitted onto the media by the D/A converter.

6.3.2. **PHY Receiver**

GMII (1000Mbps) Mode

Input signals from the media pass through the sophisticated on-chip hybrid circuit to subtract the transmitted signal from the input signal for effective reduction of near-end echo. Afterwards, the received signal is processed with state-of-the-art technology, e.g., adaptive equalization, BLW (Baseline Wander) correction, cross-talk cancellation, echo cancellation, timing recovery, error correction, and 4D-PAM5 decoding. Then, the 8-bit-wide data is recovered and is sent to the GMII interface at a clock speed of 125MHz. The Rx MAC retrieves the packet data from the receive MII/GMII interface and sends it to the Rx Buffer Manager.

MII (100Mbps) Mode

The MLT3 signal is processed with an ADC, equalizer, BLW (Baseline Wander) correction, timing recovery, MLT3 and NRZI decoder, descrambler, 4B/5B decoder, and is then presented to the MII interface in 4-bit-wide nibbles at a clock speed of 25MHz.

MII (10Mbps) Mode

The received differential signal is converted into a Manchester-encoded stream first. Next, the stream is processed with a Manchester decoder, and is de-serialized into 4-bit-wide nibbles. The 4-bit nibbles are presented to the MII interface at a clock speed of 2.5MHz.

6.4. *Next Page*

If 1000Base-T mode is advertised, three additional Next Pages are automatically exchanged between the two link partners. Users can set PHY Reg4.15 to 1 to manually exchange extra Next Pages via Reg7 and Reg8 as defined in IEEE 802.3ab.

6.5. *EEPROM Interface*

The RTL8168 requires the attachment of an external EEPROM. The 93C46/93C56 is a 1K-bit/2K-bit EEPROM. The EEPROM interface permits the RTL8168 to read from, and write data to, an external serial EEPROM device.

Values in the external EEPROM allow default fields in PCI configuration space and I/O space to be overridden following a power-on or software EEPROM auto-load command. The RTL8168 will auto-load values from the EEPROM. If the EEPROM is not present, the RTL8168 initialization uses default values for the appropriate Configuration and Operational Registers. Software can read and write to the EEPROM using bit-bang accesses via the 9346CR Register, or using PCI VPD (Vital Product Data). The interface consists of EESK, EECS, EEDO, and EEDI.

Table 10. EEPROM Interface

EEPROM	Description
EECS	93C46/93C56 chip select.
EESK	EEPROM serial data clock.
EEDI/Aux	Input data bus/Input pin to detect if Aux. Power exists on initial power-on. This pin should be connected to EEPROM. To support wakeup from ACPI D3cold or APM power-down, this pin must be pulled high to Aux. Power via a resistor. If this pin is not pulled high to Aux. Power, the RTL8168 assumes that no Aux. Power exists.
EEDO	Output data bus.

6.6. Power Management

The RTL8168 is compliant with ACPI (Rev 1.0, 1.0b, 2.0), PCI Power Management (Rev 1.1), PCI Express Active State Power Management (ASPM), and Network Device Class Power Management Reference Specification (V1.0a), such as to support an Operating System-directed Power Management (OSPM) environment.

The RTL8168 can monitor the network for a Wakeup Frame, a Magic Packet, or a Re-LinkOk, and notify the system via a PCI Express Power Management Event (PME) Message, Beacon, or LANWAKEB pin when such a packet or event occurs. Then the system can be restored to a normal state to process incoming jobs.

When the RTL8168 is in power down mode (D1 ~ D3):

- The Rx state machine is stopped. The RTL8168 monitors the network for wakeup events such as a Magic Packet, Wakeup Frame, and/or Re-LinkOk, in order to wake up the system. When in power down mode, the RTL8168 will not reflect the status of any incoming packets in the ISR register and will not receive any packets into the Rx on-chip buffer.
- The on-chip buffer status and packets that have already been received into the Rx on-chip buffer before entering power down mode are held by the RTL8168.
- Transmission is stopped. PCI Express transactions are stopped. The Tx on-chip buffer is held.
- After being restored to D0 state, the RTL8168 transmits data that was not moved into the Tx on-chip buffer during power down mode. Packets that were not transmitted completely last time are re-transmitted.

The D3cold_support_PME bit (bit15, PMC register) and the Aux_I_b2:0 bits (bit8:6, PMC register) in PCI configuration space depend on the existence of Aux power (bit15, PMC) = 1.

If EEPROM D3cold_support_PME bit (bit15, PMC) = 0, the above 4 bits are all 0's.

Example:

If EEPROM D3c_support_PME = 1:

- If aux. power exists, then PMC in PCI config space is the same as EEPROM PMC (if EEPROM PMC = C2 F7, then PCI PMC = C2 F7)
- If aux. power is absent, then PMC in PCI config space is the same as EEPROM PMC except the above 4 bits are all 0's (if EEPROM PMC = C2 F7, then PCI PMC = 02 76)

In the above case, if wakeup support is desired when main power is off, it is suggested that the EEPROM PMC be set to C2 F7 (Realtek EEPROM default value).

If EEPROM D3c_support_PME = 0:

- If aux. power exists, then PMC in PCI config space is the same as EEPROM PMC (if EEPROM PMC = C2 77, then PCI PMC = C2 77)
- If aux. power is absent, then PMC in PCI config space is the same as EEPROM PMC except the above 4 bits are all 0's (if EEPROM PMC = C2 77, then PCI PMC = 02 76)

In the above case, if wakeup support is not desired when main power is off, it is suggested that the EEPROM PMC be set to 02 76.

Link Wakeup occurs only when the following conditions are met:

- The LinkUp bit (CONFIG3#4) is set to 1, the PMEn bit (CONFIG1#0) is set to 1, and the corresponded wake-up method (message, beacon, or LANWAKEB) can be asserted in the current power state.

Magic Packet Wakeup occurs only when the following conditions are met:

- The destination address of the received Magic Packet is acceptable to the RTL8168, e.g., a broadcast, multicast, or unicast packet addressed to the current RTL8168 adapter.
- The received Magic Packet does not contain a CRC error.
- The Magic bit (CONFIG3#5) is set to 1, the PMEn bit (CONFIG1#0) is set to 1, and the corresponding wake-up method (message, beacon, or LANWAKEB) can be asserted in the current power state.
- The Magic Packet pattern matches, i.e. $6 * FFh + MISC$ (can be none) + $16 * DID$ (Destination ID) in any part of a valid Ethernet packet.

A Wakeup Frame event occurs only when the following conditions are met:

- The destination address of the received Wakeup Frame is acceptable to the RTL8168, e.g., a broadcast, multicast, or unicast address to the current RTL8168 adapter.
- The received Wakeup Frame does not contain a CRC error.
- The PMEn bit (CONFIG1#0) is set to 1.
- The 16-bit CRC^A of the received Wakeup Frame matches the 16-bit CRC of the sample Wakeup Frame pattern given by the local machine's OS. Or, the RTL8168 is configured to allow direct packet wakeup, e.g., a broadcast, multicast, or unicast network packet.

Note: 16-bit CRC: The RTL8168 supports two normal wakeup frames (covering 64 mask bytes from offset 0 to 63 of any incoming network packet) and three long wakeup frames (covering 128 mask bytes from offset 0 to 127 of any incoming network packet).

The corresponding wake-up method (message, beacon, or LANWAKEB) is asserted only when the following conditions are met:

- The PMEn bit (bit0, CONFIG1) is set to 1.
- The PME_En bit (bit8, PMCSR) in PCI Configuration Space is set to 1.
- The RTL8168 may assert the corresponding wake-up method (message, beacon, or LANWAKEB) in the current power state or in isolation state, depending on the PME_Support (bit15-11) setting of the PMC register in PCI Configuration Space.
- A Magic Packet, LinkUp, or Wakeup Frame has been received.
- Writing a 1 to the PME_Status (bit15) of the PMCSR register in the PCI Configuration Space clears this bit and causes the RTL8168 to stop asserting the corresponding wake-up method (message, beacon, or LANWAKEB) (if enabled).

When the RTL8168 is in power down mode, e.g., D1-D3, the IO and MEM accesses to the RTL8168 are disabled. After a PERSTB assertion, the device's power state is restored to D0 automatically if the original power state was D3_{cold}. There is almost no hardware delay at the device's power state transition. When in ACPI mode, the device does not support PME (Power Management Enable) from D0 (this is the Realtek default setting of the PMC register auto-loaded from EEPROM). The setting may be changed from the EEPROM, if required.

6.7. Vital Product Data (VPD)

Bit 31 of the Vital Product Data (VPD) capability structure in the RTL8168's PCI Configuration Space is used to issue VPD read/write commands and is also a flag used to indicate whether the transfer of data between the VPD data register and the 93C46/93C56 has completed or not.

1. Write VPD register: (write data to the 93C46/93C56)
Set the flag bit to 1 at the same time the VPD address is written to write VPD data to EEPROM. When the flag bit is reset to 0 by the RTL8168, the VPD data (4 bytes per VPD access) has been transferred from the VPD data register to EEPROM.
2. Read VPD register: (read data from the 93C46/93C56)
Reset the flag bit to 0 at the same time the VPD address is written to retrieve VPD data from EEPROM. When the flag bit is set to 1 by the RTL8168, the VPD data (4 bytes per VPD access) has been transferred from EEPROM to the VPD data register.

Note1: Refer to the PCI 2.2 Specifications for further information.

Note2: The VPD address must be a DWORD-aligned address as defined in the PCI 2.2 Specifications. VPD data is always consecutive 4-byte data starting from the VPD address specified.

Note3: Realtek reserves offset 40h to 7Fh in EEPROM mainly for VPD data to be stored.

Note4: The VPD function of the RTL8168 is designed to be able to access the full range of the 93C46/93C56 EEPROM.

7. Characteristics

7.1. Absolute Maximum Ratings

WARNING: Absolute maximum ratings are limits beyond which permanent damage may be caused to the device, or device reliability will be affected. All voltages are specified reference to GND unless otherwise specified.

Table 11. Absolute Maximum Ratings

Symbol	Description	Minimum	Maximum	Unit
VDD3, HV1VDD	Supply Voltage 3.3V	-0.5	4	V
V0VDD	Supply Voltage 2.5V	-0.5	3	V
VDD1A, VDD20, LV2VDD	Supply Voltage V*			V
VDD1	Supply Voltage 1.8V	-0.5	2.3	V
DCinput	Input Voltage	-0.5	Corresponding Supply Voltage + 0.5	V
DCoutput	Output Voltage	-0.5	Corresponding Supply Voltage + 0.5	V
	Storage Temperature	-55	+125	°C

* Please refer to the most updated schematic circuit for correct configuration.

7.2. Recommended Operating Conditions

Table 12. Recommended Operating Conditions

Description	Pins	Minimum	Typical	Maximum	Unit
Supply Voltage VDD	VDD3, HV1VDD	3.0	3.3	3.6	V
	V0VDD	2.25	2.5	2.75	V
	VDD1A, VDD20, LV2VDD	*			V
	VDD1	1.71	1.8	1.89	V
Ambient Temperature T_A		0		70	°C
Maximum Junction Temperature				125	°C

* Please refer to the most updated schematic circuit for correct configuration.

7.3. Crystal Requirements

Table 13. Crystal Requirements

Symbol	Description/Condition	Minimum	Typical	Maximum	Unit
F_{ref}	Parallel resonant crystal reference frequency, fundamental mode, AT-cut type.		25		MHz
F_{ref} Stability	Parallel resonant crystal frequency stability, fundamental mode, AT-cut type. $T_a=25^\circ\text{C}$.	-50		+50	ppm
F_{ref} Tolerance	Parallel resonant crystal frequency tolerance, fundamental mode, AT-cut type. $T_a=-20^\circ\text{C} \sim +70^\circ\text{C}$.	-30		+30	ppm
F_{ref} Duty Cycle	Reference clock input duty cycle.	40		60	%
C_L	Load Capacitance.				pF
ESR	Equivalent Series Resistance.				Ω
DL	Drive Level.			0.5	mW

7.4. Thermal Characteristics

Table 14. Thermal Characteristics

Parameter	Minimum	Maximum	Units
Storage temperature	-55	+125	°C
Operating temperature	0	70	°C

7.5. DC Characteristics

Table 15. DC Characteristics

Symbol	Parameter	Conditions	Minimum	Typical	Maximum	Units
VDD3, LV1VDD	3.3V Supply Voltage		3.0	3.3	3.6	V
V0VDD	2.5V Supply Voltage		2.25	2.5	2.75	V
VDD1A, LV2VDD, VDD20	Supply Voltage*					V
VDD1	1.8V Supply Voltage		1.71	1.8	1.89	V
Voh	Minimum High Level Output Voltage	Ioh = -8mA	0.9 * VDD3		VDD3	V
Vol	Maximum Low Level Output Voltage	Iol= 8mA			0.1 * VDD3	V
Vih	Minimum High Level Input Voltage		0.5 * VDD3		VDD3+0.5	V
Vil	Maximum Low Level Input Voltage		-0.5		0.3 * VDD3	V
Iin	Input Current	Vin = VDD3 or GND	-1.0		1.0	μA
Icc33	Average Operating Supply Current from 3.3V			TBD		mA
Icc25	Average Operating Supply Current from 2.5V			TBD		mA
Icc20	Average Operating Supply Current			TBD		mA
Icc18	Average Operating Supply Current from 1.8V			TBD		mA

* Please refer to the most updated schematic circuit for correct configuration.

7.6. AC Characteristics

7.6.1. Serial EEPROM Interface Timing

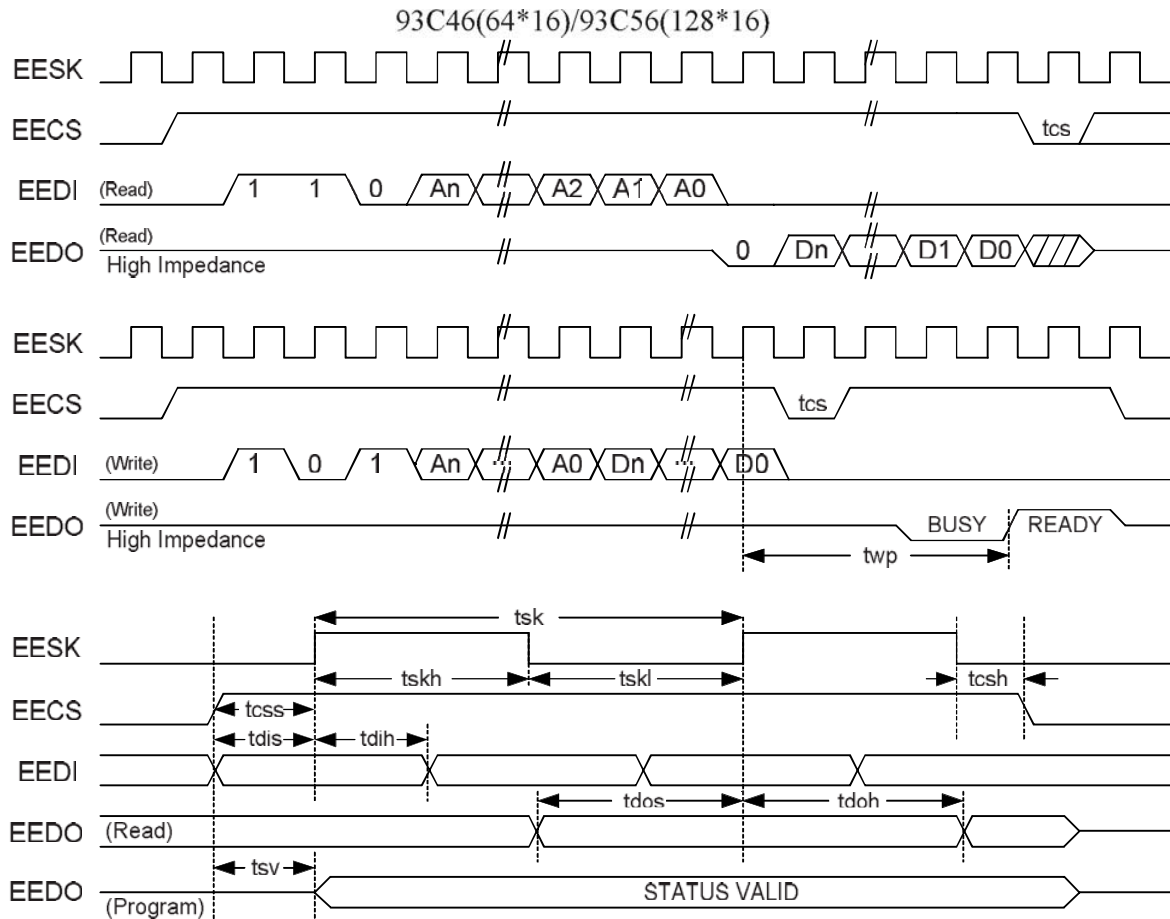

Figure 6. Serial EEPROM Interface Timing

Table 16. EEPROM Access Timing Parameters

Symbol	Parameter	EEPROM Type	Min	Max	Unit
tcs	Minimum CS Low Time	9346	1000		ns
twp	Write Cycle Time	9346		10	ms
tsk	SK Clock Cycle Time	9346	4		μs
tskh	SK High Time	9346	1000		ns
tskl	SK Low Time	9346	1000		ns
tcss	CS Setup Time	9346	200		ns
tcsh	CS Hold Time	9346	0		ns
tdis	DI Setup Time	9346	400		ns
tdih	DI Hold Time	9346	400		ns
tdos	DO Setup Time	9346	2000		ns
tdoh	DO Hold Time	9346		2000	ns
tsv	CS to Status Valid	9346		1000	ns

7.7. BOOT ROM Timing

7.7.1. BOOT ROM - Read

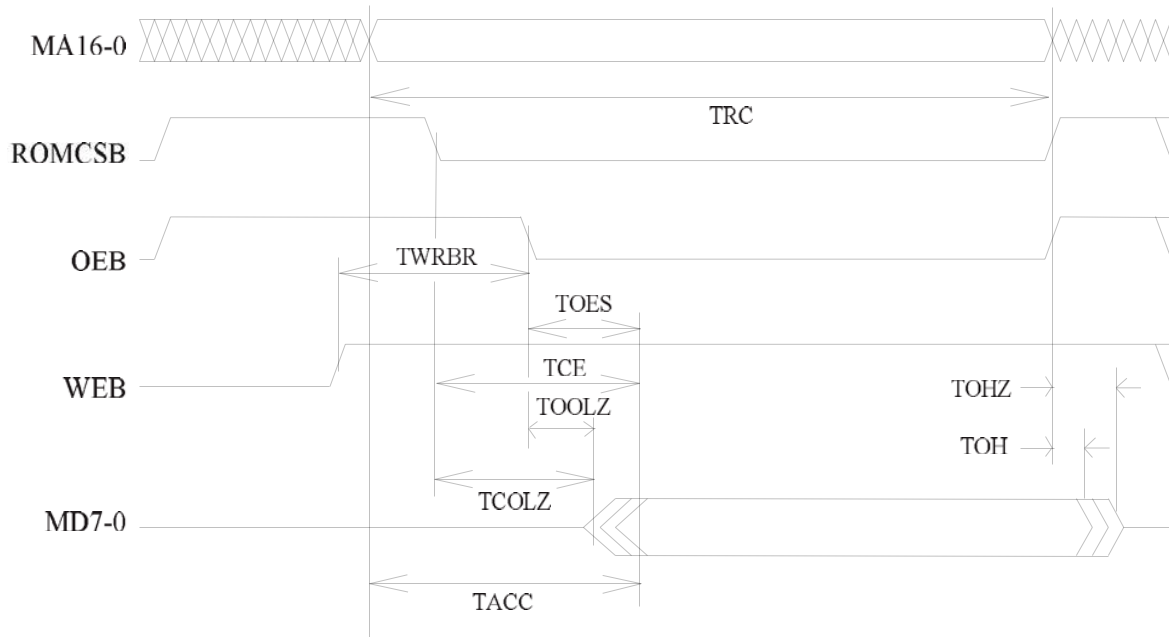

Figure 7. BOOT ROM - Read

Table 17. BOOT ROM - Read

Symbol	Description	Minimum	Typical	Maximum	Units
TRC	Read Cycle	135	-	-	ns
TCE	Chip Enable Access Time	-	-	200	ns
TACC	Address Access Time	-	-	200	ns
TOES	Output Enable Access Time	-	-	60	ns
TCOLZ	Chip Enable to Output in Low Z	0	-	-	ns
TOOLZ	Output Enable to Output in Low Z	0	-	-	ns
TOHZ	Output Disable to Output in High Z	-	-	40	ns
TOH	Output Hold from Address, ROMCSB, or OEB	0	-	0	ns
TWRBR	Write Recovery time Before Read	6	-	-	μs

7.8. PCI Express Bus Parameters

7.8.1. Differential Transmitter Parameters

Table 18. Differential Transmitter Parameters

Symbol	Parameter	Min	Typical	Max	Units
UI	Unit Interval ²	399.88	400	400.12	ps
V _{TX-DIFFp-p}	Differential Peak to Peak Output Voltage	0.800		1.2	V
V _{TX-DR-RATIO}	De-Emphasized Differential Output Voltage (Ratio)	-3.0	-3.5	-4.0	dB
T _{TX-EYE}	Minimum Tx Eye Width	0.70			UI
T _{TX-EYE-MEDIAN-to-MAX-JITTER}	Maximum time between the jitter median and maximum deviation from the median			0.15	UI
T _{TX-RISE} , T _{TX-FALL}	D+/D- Tx Output Rise/Fall Time	0.125			UI
V _{TX-CM-ACp}	RMS AC Peak Common Mode Output Voltage			20	mV
V _{TX-CM-DCACTIVE-IDLEDELTA}	Absolute Delta of DC Common Mode Voltage During L0 and Electrical Idle	0		100	mV
V _{TX-CM-DCLINE-DELTA}	Absolute Delta of DC Common Mode Voltage between D+ and D-	0		25	mV
V _{TX-IDLE-DIFFp}	Electrical Idle Differential Peak Output Voltage	0		20	mV
V _{TX-RCV-DETECT}	The amount of voltage change allowed during Receiver Detection			600	mV
V _{TX-DC-CM}	The TX DC Common Mode Voltage	0		3.6	V
I _{TX-SHORT}	TX Short Circuit Current Limit			90	mA
T _{TX-IDLE-MIN}	Minimum time spent in Electrical Idle	50			UI
T _{TX-IDLE-SHTTO-IDLE}	Maximum time to transition to a valid Electrical Idle after sending an Electrical Idle ordered set			20	UI
T _{TX-IDLE-TOTO-DIFF-DATA}	Maximum time to transition to valid TX specifications after leaving an Electrical Idle condition			20	UI
RL _{TX-DIFF}	Differential Return Loss	12			dB
RL _{TX-CM}	Common Mode Return Loss	6			dB
Z _{TX-DIFF-DC}	DC Differential TX Impedance	80	100	120	Ω
Z _{TX-DC}	Transmitter DC Impedance	40			Ω
L _{TX-SKEW}	Lane-to-Lane Output Skew			500+2 UI	ps
C _{TX}	AC Coupling Capacitor	75		200	nF
T _{crosslink}	Crosslink Random Timeout	0		1	ms

Note1: Refer to PCI Express Base Specification, rev.1.0a, for correct measurement environment setting of each parameter.

Note2: The data rate can be modulated with an SSC (Spread Spectrum Clock) from +0 to -0.5% of the nominal data rate frequency, at a modulation rate in the range not exceeding 30 kHz – 33 kHz. The +/- 300 ppm requirement still holds, which requires the two communicating ports be modulated such that they never exceed a total of 600 ppm difference.

7.8.2. Differential Receiver Parameters

Table 19. Differential Receiver Parameters

Symbol	Parameter	100MHz Input			Units
		Min	Typical	Max	
UI	Unit Interval	399.88	400	400.12	ps
$V_{RX-DIFFp-p}$	Differential Input Peak to Peak Voltage	0.175		1.200	V
T_{RX-EYE}	Minimum Receiver Eye Width	0.4			UI
$T_{RX-EYE-MEDIAN-t_{MAX-JITTER}}$	Maximum time between the jitter median and maximum deviation from the median			0.3	UI
$V_{RX-CM-ACp}$	AC Peak Common Mode Input Voltage			150	mV
$RL_{RX-DIFF}$	Differential Return Loss	15			dB
RL_{RX-CM}	Common Mode Return Loss	6			dB
$Z_{RX-DIFF-DC}$	DC Differential Input Impedance	80	100	120	Ω
Z_{RX-DC}	DC Input Impedance	40	50	60	Ω
$Z_{RX-HIGH-IMP-DC}$	Powered Down DC Input Impedance	200 k			Ω
$V_{RX-IDLE-DET-DIFFp-p}$	Electrical Idle Detect Threshold	65		175	mV
$T_{RX-IDLE-DET-DIFF-INT}$	Unexpected Electrical Idle Enter Detect Threshold Integration Time			10	ms
$L_{RX-SKEW}$	Total Skew			20	ns

Note: Refer to PCI Express Base Specification, rev.1.0a, for correct measurement environment setting of each parameter.

7.8.3. REFCLK Parameters

Table 20. REFCLK Parameters

Symbol	Parameter	100MHz Input		Units
		Min	Max	
T_{absmin}	Absolute min. DIF CLK Period	9,872		ns
T_{rise}	Rise Time	175	700	ps
T_{fall}	Fall Time	175	700	ps
$h \Delta T_{rise}$	Rise Time Variation		125	ps
ΔT_{fall}	Fall Time Variation		125	ps
Rise/Fall Matching			20	%
V_{high}	Voltage High (typical 0.71V)	660	850	mV
V_{low}	Voltage Low (typical 0.0V)	-150		mV
$V_{cross absolute}$	Absolute Crossing Point Voltages	250	550	mV
$V_{cross relative}$	Relative Crossing Point Voltages	Note ²	Note ²	V
Total ΔV_{cross}	Total Variation of V_{cross} over all edges		140	mV
$T_{ejitter}$	Cycle to Cycle Jitter		125	ps
Duty Cycle		45	55	%
V_{ovs}	Maximum Voltage (Overshoot)		$V_{high avg} + 0.3$	V
V_{uds}	Minimum Voltage (Undershoot)		-0.3	V
V_{rb}	Ringback Voltage	0.2	N/A	V

Note1: Refer to PCI Express Base Specification, rev.1.0a, for correct measurement environment setting of each parameter.

Note2: $V_{cross relative Min} = 0.5(V_{high avg} - 0.710) + 0.250$, $V_{cross relative Max} = 0.5(V_{high avg} - 0.710) + 0.550$. The crossing point must meet the absolute and relative crossing point specifications simultaneously.

Note3: The nominal single-ended swing for each clock is 0 to 0.7V with a nominal frequency of 100MHz \pm 300 PPM.

Note4: The reference clocks may support spread spectrum clocking. The minimum clock period cannot be violated.

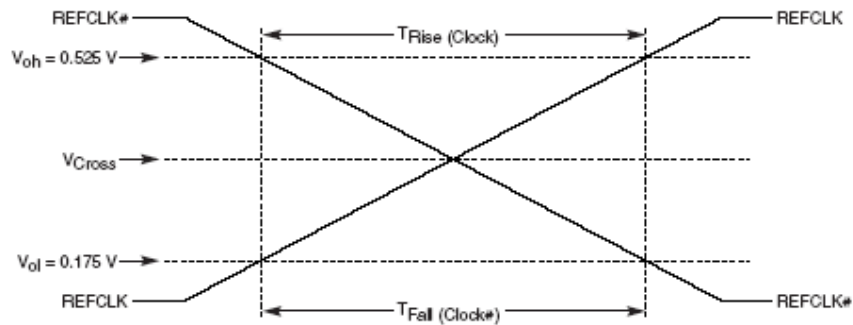

Figure 8. REFCLK Single-Ended Measurement Points for T_{rise} and T_{fall}

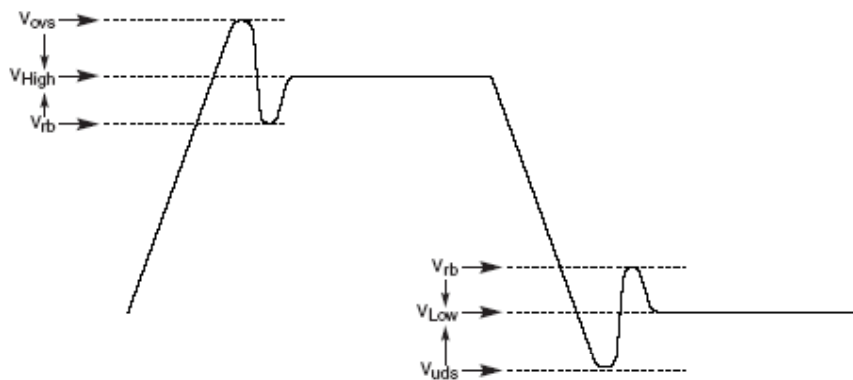

Figure 9. REFCLK Single-Ended Measurement Points for V_{ovs} , V_{uds} , and V_{rb}

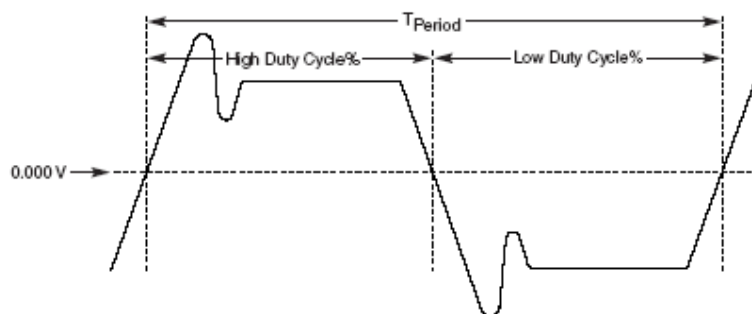
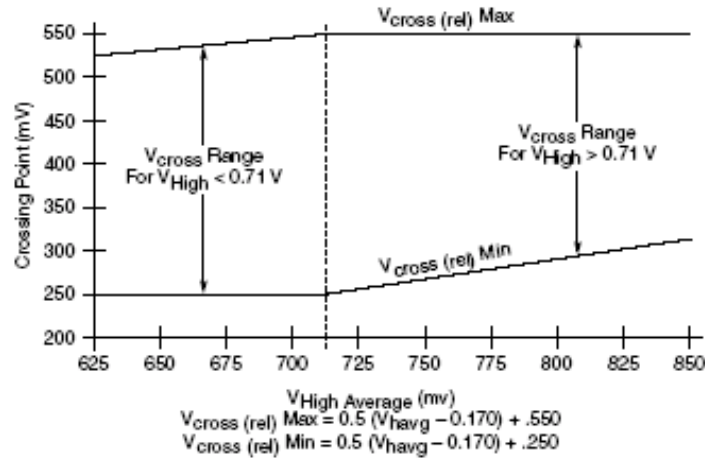

Figure 10. REFCLK Differential Measurement Points for T_{period} , Duty Cycle, and Jitter

Figure 11. REFCLK V_{cross} Range

7.8.4. Auxiliary Signal Timing Parameters

Table 21. Auxiliary Signal Timing Parameters

Symbol	Parameter	Min	Max	Units
$T_{>VPERL}$	Power stable to PERSTB inactive	100		ms
$T_{\text{PERST-CLK}}$	REFCLK stable before PERSTB inactive	100		μs
T_{PERST}	PERSTB active time	100		μs
T_{TAIL}	Power level invalid to PWRGD inactive		500	ns
T_{WKRF}	LANWAKEB rise – fall time		100	ns

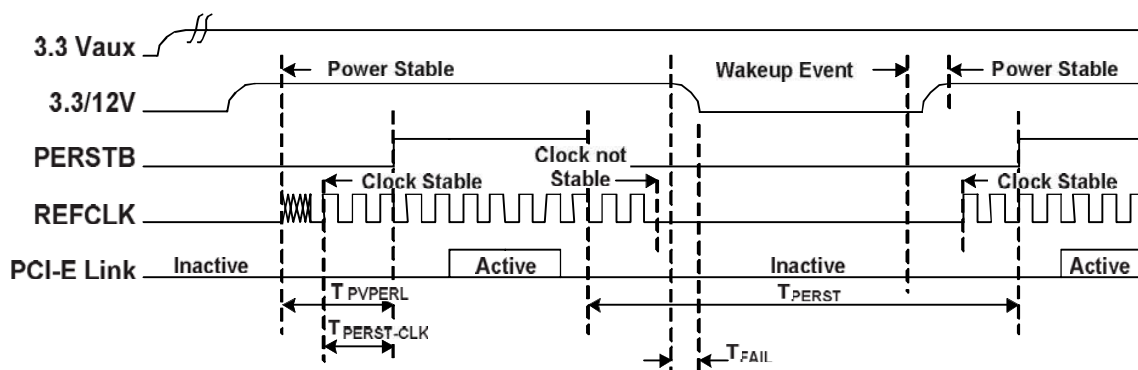
Figure 12. Auxiliary Signal Timing

8. Mechanical Dimensions

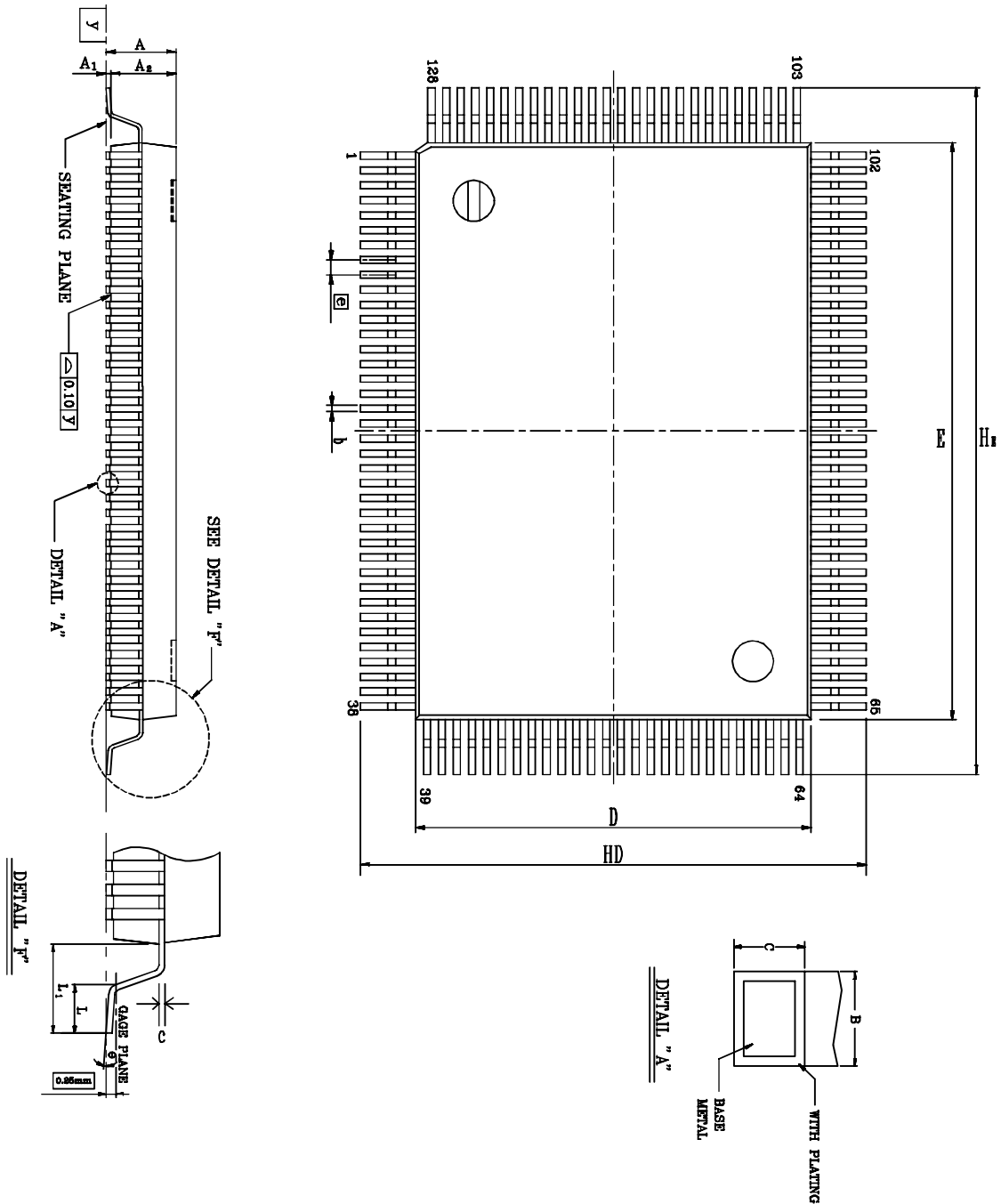

See the Mechanical Dimensions notes on the next page.

8.1. Mechanical Dimensions Notes

Symbol	Dimensions in inches			Dimensions in mm		
	Min	Typical	Max	Min	Typical	Max
A	-	-	0.134	-	-	3.40
A1	0.004	0.010	0.036	0.10	0.25	0.91
A2	0.102	0.112	0.122	2.60	2.85	3.10
b	0.005	0.009	0.013	0.12	0.22	0.32
c	0.002	0.006	0.010	0.05	0.15	0.25
D	0.541	0.551	0.561	13.75	14.00	14.25
E	0.778	0.787	0.797	19.75	20.00	20.25
e	0.010	0.020	0.030	0.25	0.5	0.75
HD	0.665	0.677	0.689	16.90	17.20	17.50
HE	0.902	0.913	0.925	22.90	23.20	23.50
L	0.027	0.035	0.043	0.68	0.88	1.08
L1	0.053	0.063	0.073	1.35	1.60	1.85
y	-	-	0.004	-	-	0.10
θ	0°	-	12°	0°	-	12°

Notes:

1. Dimensions D & E do not include interlead flash.
2. Dimension b does not include dambar protrusion/intrusion.
3. Controlling dimension: Millimeter
4. General appearance spec. Should be based on final visual inspection.

TITLE: 128 DHS-QFP (14x20 mm) PACKAGE OUTLINE -CU L/F, FOOTPRINT 3.2 mm			
LEADFRAME MATERIAL			
APPROVE		DOC. NO.	
		VERSION	
		PAGE	
CHECK		DWG NO.	Q128 - 1
		DATE	
REALTEK SEMICONDUCTOR CORP.			

9. Ordering Information

Table 22. Ordering Information

Part Number	Package	Status
RTL8168	128-pin DHS-QFP	
RTL8168-LF	128-pin DHS-QFP Lead (Pb)-Free	

Realtek Semiconductor Corp.
Headquarters

No. 2, Industry East Road IX, Science-based
Industrial Park, Hsinchu, 300, Taiwan, R.O.C.
Tel: 886-3-5780211 Fax: 886-3-5776047
www.realtek.com.tw