

Data Sheet  
May 2000

Lucent Technologies  
Bell Labs Innovations

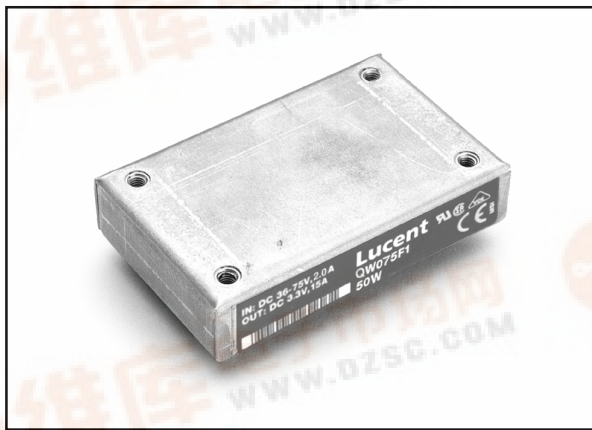

## QW050F1 and QW075F1 Power Modules: dc-dc Converters; 36 to 75 Vdc Input, 3.3 Vdc Output; 33 W to 50 W



The QW Series Power Modules use advanced, surface-mount technology and deliver high-quality, efficient, and compact dc-dc conversion.

### Features

- Small size: 36.8 mm x 57.9 mm x 12.7 mm (1.45 in. x 2.28 in. x 0.50 in.)
- High power density
- High efficiency: 81% typical
- Low output noise
- Constant frequency
- Industry-standard pinout
- Metal baseplate
- 2:1 input voltage range
- Overvoltage and overcurrent protection
- Remote on/off
- Remote sense
- Adjustable output voltage
- Overtemperature protection
- ISO\* 9001 Certified manufacturing facilities
- UL†1950 Recognized, CSA‡ C22.2 No. 950-95 Certified, and VDE§ 0805 (EN60950, IEC950) Licensed
- CE mark meets 73/23/EEC and 93/68/EEC directives\*\*

\* ISO is a registered trademark of the International Organization for Standardization.

† UL is a registered trademark of Underwriters Laboratories, Inc.

‡ CSA is a registered trademark of Canadian Standards Association.

§ VDE is a trademark of Verband Deutscher Elektrotechniker e.V.

\*\* This product is intended for integration into end-use equipment. All the required procedures for CE marking of end-use equipment should be followed. (The CE mark is placed on selected products.)

### Applications

- Distributed power architectures
- Workstations
- Computer equipment
- Communications equipment

### Options

- Heat sinks available for extended operation
- Auto-restart after overcurrent shutdown

### Description

The QW050F1 and QW075F1 Power Modules are dc-dc converters that operate over an input voltage range of 36 Vdc to 75 Vdc and provide a precisely regulated dc output. The outputs are fully isolated from the inputs, allowing versatile polarity configurations and grounding connections. The modules have maximum power ratings from 33 W to 50 W at a typical full-load efficiency of 81%.

The sealed modules offer a metal baseplate for excellent thermal performance. Threaded-through holes are provided to allow easy mounting or addition of a heat sink for high-temperature applications. The standard feature set includes remote sensing, output trim, and remote on/off for convenient flexibility in distributed power applications.



## Absolute Maximum Ratings

Stresses in excess of the absolute maximum ratings can cause permanent damage to the device. These are absolute stress ratings only. Functional operation of the device is not implied at these or any other conditions in excess of those given in the operations sections of the data sheet. Exposure to absolute maximum ratings for extended periods can adversely affect device reliability.

Parameter	Symbol	Min	Max	Unit
Input Voltage: Continuous	$V_I$	—	75	Vdc
Transient (100 ms)	$V_{I, trans}$	—	100	V
Operating Case Temperature (See Thermal Considerations section.)	$T_C$	-40	100	°C
Storage Temperature	$T_{stg}$	-55	125	°C
I/O Isolation Voltage (for 1 minute)	—	—	1500	Vdc

## Electrical Specifications

Unless otherwise indicated, specifications apply over all operating input voltage, resistive load, and temperature conditions.

**Table 1. Input Specifications**

Parameter	Symbol	Min	Typ	Max	Unit
Operating Input Voltage	$V_I$	36	48	75	Vdc
Maximum Input Current ( $V_I = 0$ V to 75 V; $I_o = I_{o, max}$ ; see Figures 1 and 2):					
QW050F1	$I_{I, max}$	—	—	2.5	A
QW075F1	$I_{I, max}$	—	—	3.5	A
Inrush Transient	$i^2t$	—	—	1.3	A <sup>2</sup> s
Input Reflected-ripple Current, Peak-to-peak (5 Hz to 20 MHz, 12 $\mu$ H source impedance; see Figure 13.)	$I_r$	—	10	—	mAp-p
Input Ripple Rejection (120 Hz)	—	—	60	—	dB

## Fusing Considerations

**CAUTION: This power module is not internally fused. An input line fuse must always be used.**

This encapsulated power module can be used in a wide variety of applications, ranging from simple stand-alone operation to an integrated part of a sophisticated power architecture. To preserve maximum flexibility, internal fusing is not included; however, to achieve maximum safety and system protection, always use an input line fuse. The safety agencies require a normal-blow fuse with a maximum rating of 3 A (see Safety Considerations section). Based on the information provided in this data sheet on inrush energy and maximum dc input current, the same type of fuse with a lower rating can be used. Refer to the fuse manufacturer's data for further information.

**Electrical Specifications** (continued)

**Table 2. Output Specifications**

Parameter	Device	Symbol	Min	Typ	Max	Unit
Output Voltage Set Point ( $V_I = 48\text{ V}$ ; $I_O = I_{O, \text{max}}$ ; $T_C = 25\text{ }^\circ\text{C}$ )	All	$V_{O, \text{set}}$	3.25	3.3	3.35	Vdc
Output Voltage (Over all operating input voltage, resistive load, and temperature conditions until end of life. See Figure 15.)	All	$V_O$	3.20	—	3.40	Vdc
Output Regulation: Line ( $V_I = 36\text{ V}$ to $75\text{ V}$ ) Load ( $I_O = I_{O, \text{min}}$ to $I_{O, \text{max}}$ ) Temperature ( $T_C = -40\text{ }^\circ\text{C}$ to $+100\text{ }^\circ\text{C}$ )	All All All	— — —	— — —	0.01 0.05 15	0.1 0.2 50	% $V_O$ % $V_O$ mV
Output Ripple and Noise Voltage (See Figure 14.): RMS Peak-to-peak (5 Hz to 20 MHz)	All All	— —	— —	— —	40 150	mVrms mVp-p
External Load Capacitance	All	—	0	—	*	$\mu\text{F}$
Output Current (At $I_O < I_{O, \text{min}}$ , the modules may exceed output ripple specifications.)	QW050F1 QW075F1	$I_O$ $I_O$	0.5 0.5	— —	10 15	A A
Output Current-limit Inception ( $V_O = 90\%$ of $V_{O, \text{nom}}$ )	QW050F1 QW075F1	$I_{O, \text{cli}}$ $I_{O, \text{cli}}$	— —	15 20	20 <sup>†</sup> 26 <sup>†</sup>	A A
Efficiency ( $V_I = 48\text{ V}$ ; $I_O = I_{O, \text{max}}$ ; $T_C = 70\text{ }^\circ\text{C}$ )	QW050F1 QW075F1	$\eta$ $\eta$	— —	81 81	— —	% %
Switching Frequency	All	—	—	380	—	kHz
Dynamic Response ( $\Delta I_O/\Delta t = 1\text{ A}/10\text{ }\mu\text{s}$ , $V_I = 48\text{ V}$ , $T_C = 25\text{ }^\circ\text{C}$ ; tested with a $1000\text{ }\mu\text{F}$ aluminum and a $1.0\text{ }\mu\text{F}$ ceramic capacitor across the load.): Load Change from $I_O = 50\%$ to $75\%$ of $I_{O, \text{max}}$ : Peak Deviation Settling Time ( $V_O < 10\%$ of peak deviation) Load Change from $I_O = 50\%$ to $25\%$ of $I_{O, \text{max}}$ : Peak Deviation Settling Time ( $V_O < 10\%$ of peak deviation)	All	— — — —	— — — —	5 700 5 700	— — — —	% $V_{O, \text{set}}$ $\mu\text{s}$ % $V_{O, \text{set}}$ $\mu\text{s}$

\* Consult your sales representative or the factory.

† These are manufacturing test limits. In some situations, results may differ.

**Table 3. Isolation Specifications**

Parameter	Min	Typ	Max	Unit
Isolation Capacitance	—	2500	—	pF
Isolation Resistance	10	—	—	M $\Omega$



### Characteristic Curves

The following figures provide typical characteristics for the power modules. The figures are identical for both on/off configurations.

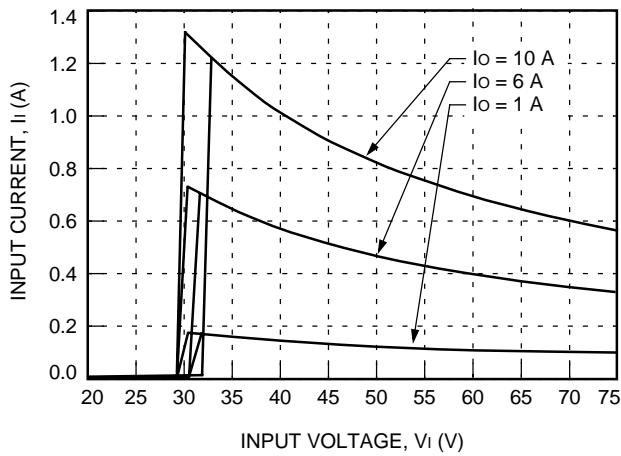

8-2959 (F)

Figure 1. Typical QW050F1 Input Characteristics at Room Temperature

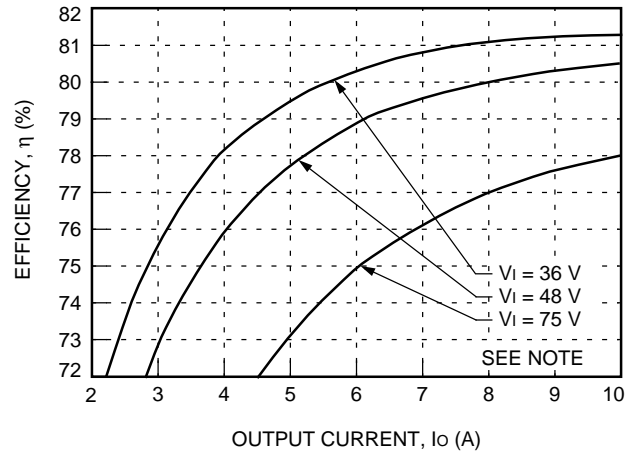

8-2960 (F)

Note: Pending improvement will add 1% to the above curves.

Figure 3. Typical QW050F1 Converter Efficiency vs. Output Current at Room Temperature

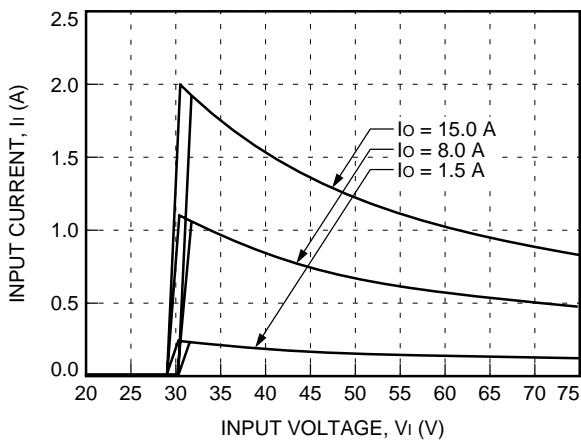

8-3032 (F)

Figure 2. Typical QW075F1 Input Characteristics at Room Temperature

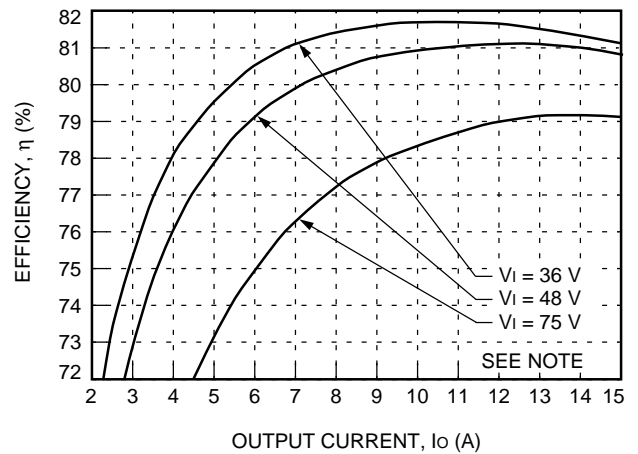

8-2961 (F)

Note: Pending improvement will add 1% to the above curves.

Figure 4. Typical QW075F1 Converter Efficiency vs. Output Current at Room Temperature

**Characteristic Curves (continued)**

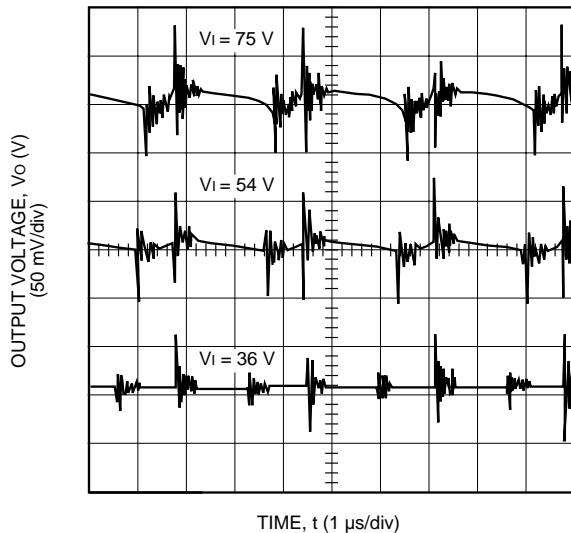

8-2070 (C)

Note: See Figure 14 for test conditions.

**Figure 5. Typical QW050F1 Output Ripple Voltage at Room Temperature and 10 A Output**

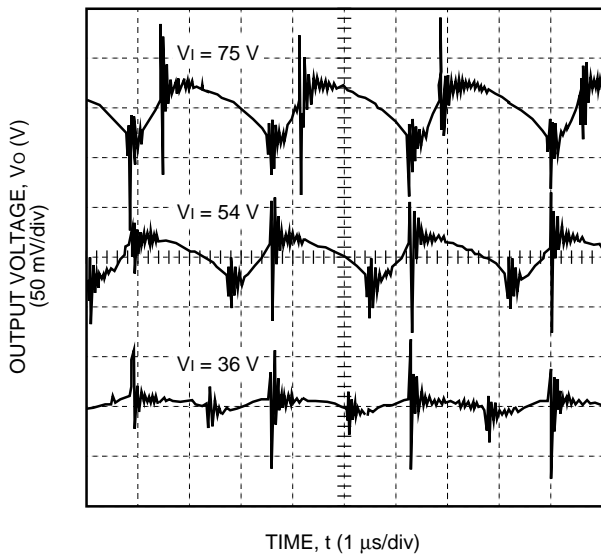

8-3033 (F)

Note: See Figure 14 for test conditions.

**Figure 6. Typical QW075F1 Output Ripple Voltage at Room Temperature and 10 A Output**

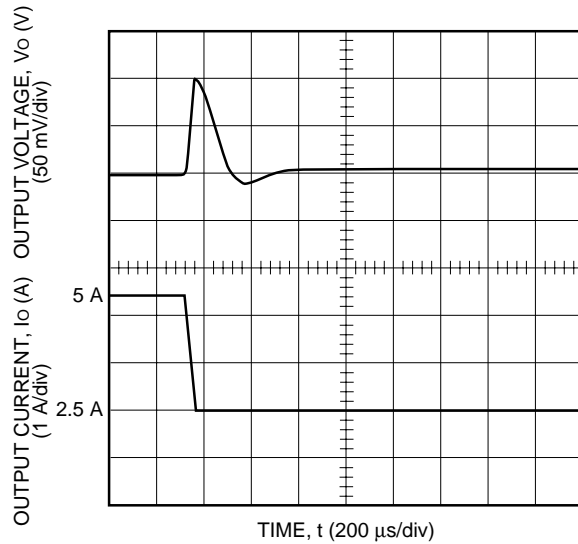

8-2962 (F)

Note: Tested with a 1000  $\mu$ F aluminum and a 1.0  $\mu$ F ceramic capacitor across the load.

**Figure 7. Typical QW050F1 Transient Response to Step Decrease in Load from 50% to 25% of  $I_{o,max}$  at Room Temperature and 54 Vdc Input (Waveform Averaged to Eliminate Ripple Component.)**

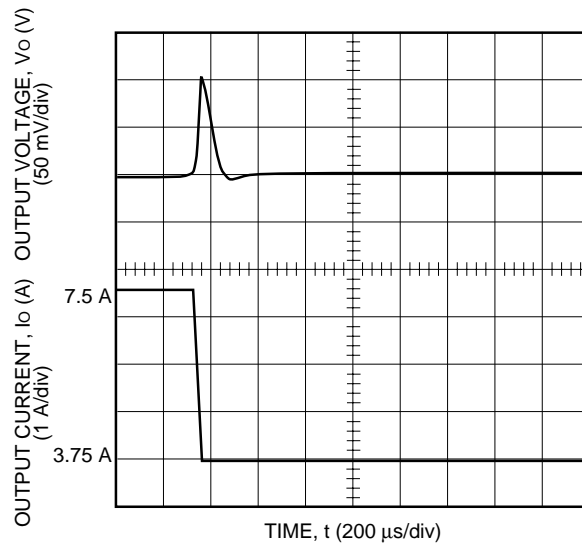

8-2963 (F)

Note: Tested with a 1000  $\mu$ F aluminum and a 1.0  $\mu$ F ceramic capacitor across the load.

**Figure 8. Typical QW075F1 Transient Response to Step Decrease in Load from 50% to 25% of  $I_{o,max}$  at Room Temperature and 54 Vdc Input (Waveform Averaged to Eliminate Ripple Component.)**

Characteristic Curves (continued)

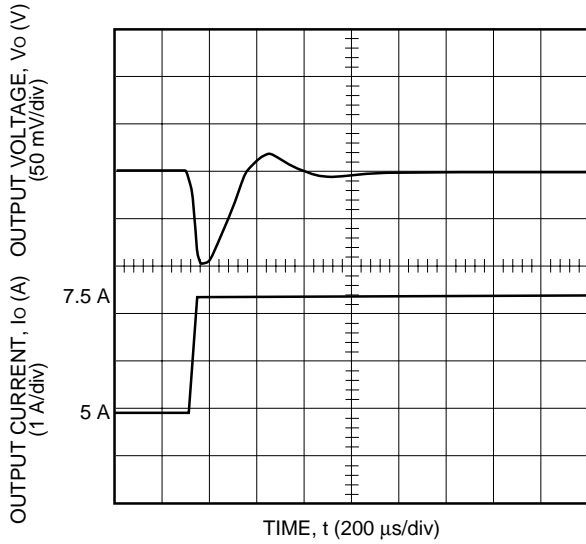

8-2964 (F)

Note: Tested with a 1000  $\mu$ F aluminum and a 1.0  $\mu$ F ceramic capacitor across the load.

**Figure 9. Typical QW050F1 Transient Response to Step Increase in Load from 50% to 75% of  $I_{o,max}$  at Room Temperature and 54 Vdc Input (Waveform Averaged to Eliminate Ripple Component.)**

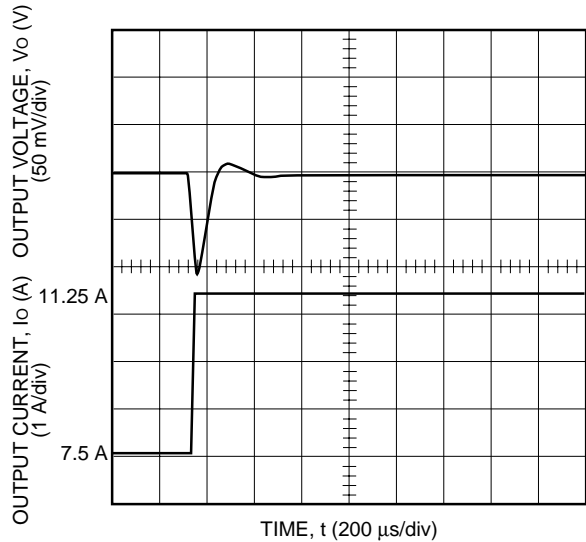

8-2965 (F)

Note: Tested with a 1000  $\mu$ F aluminum and a 1.0  $\mu$ F ceramic capacitor across the load.

**Figure 10. Typical QW075F1 Transient Response to Step Increase in Load from 50% to 75% of  $I_{o,max}$  at Room Temperature and 54 Vdc Input (Waveform Averaged to Eliminate Ripple Component.)**

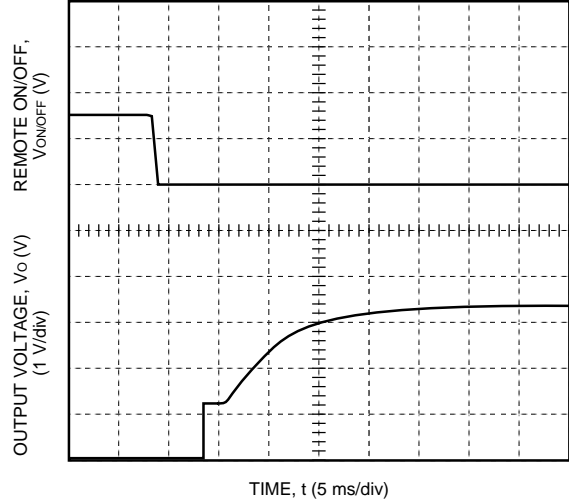

8-3034 (F)

Note: Tested with a 1000  $\mu$ F aluminum and a 1.0  $\mu$ F ceramic capacitor across the load.

**Figure 11. QW050F1 Typical Start-Up from Remote On/Off;  $I_o = I_{o,max}$**

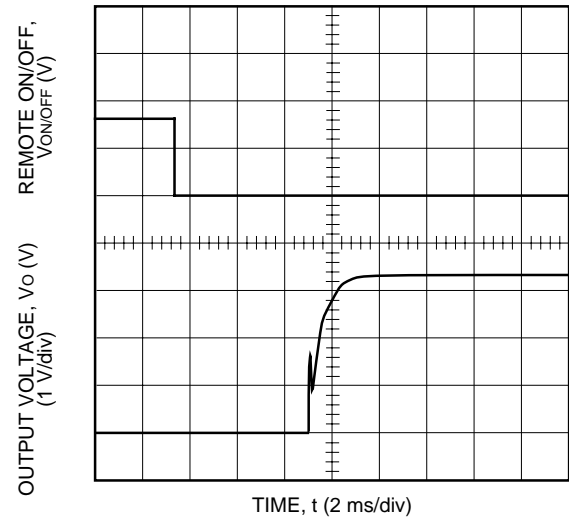

8-2966 (F)

Note: Tested with a 1000  $\mu$ F aluminum and a 1.0  $\mu$ F ceramic capacitor across the load.

**Figure 12. QW075F1 Typical Start-Up from Remote On/Off;  $I_o = I_{o,max}$**

**Test Configurations**

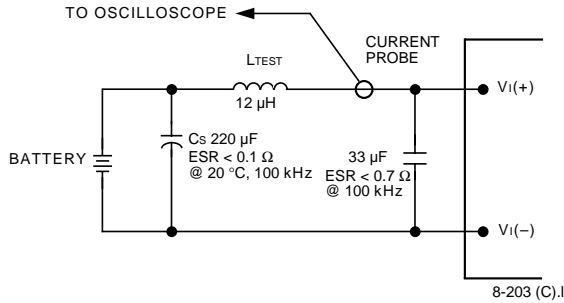

Note: Measure input reflected-ripple current with a simulated source inductance (LTEST) of 12 μH. Capacitor Cs offsets possible battery impedance. Measure current as shown above.

**Figure 13. Input Reflected-Ripple Test Setup**

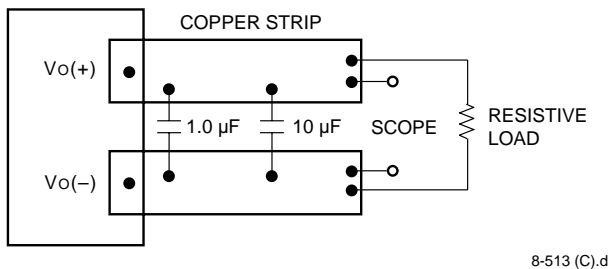

Note: Use a 1.0 μF ceramic capacitor and a 10 μF aluminum or tantalum capacitor. Scope measurement should be made using a BNC socket. Position the load between 51 mm and 76 mm (2 in. and 3 in.) from the module.

**Figure 14. Peak-to-Peak Output Noise Measurement Test Setup**

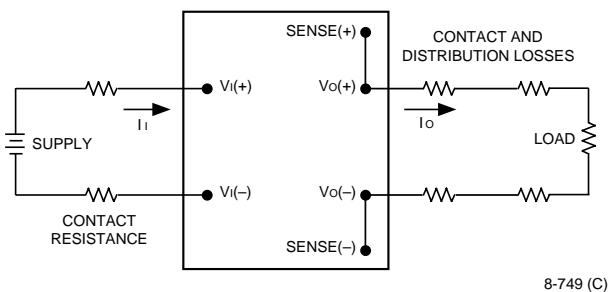

Note: All measurements are taken at the module terminals. When socketing, place Kelvin connections at module terminals to avoid measurement errors due to socket contact resistance.

$$\eta = \left( \frac{[V_{O(+)} - V_{O(-)}]I_o}{[V_{I(+)} - V_{I(-)}]I_i} \right) \times 100 \quad \%$$

**Figure 15. Output Voltage and Efficiency Measurement Test Setup**

**Design Considerations**

**Input Source Impedance**

The power module should be connected to a low ac-impedance input source. Highly inductive source impedances can affect the stability of the power module. For the test configuration in Figure 13, a 33 μF electrolytic capacitor (ESR < 0.7 Ω at 100 kHz) mounted close to the power module helps ensure stability of the unit. For other highly inductive source impedances, consult the factory for further application guidelines.

**Safety Considerations**

For safety-agency approval of the system in which the power module is used, the power module must be installed in compliance with the spacing and separation requirements of the end-use safety agency standard, i.e., UL1950, CSA C22.2 No. 950-95, and VDE 0805 (EN60950, IEC950).

If the input source is non-SELV (ELV or a hazardous voltage greater than 60 Vdc and less than or equal to 75 Vdc), for the module's output to be considered meeting the requirements of safety extra-low voltage (SELV), all of the following must be true:

- The input source is to be provided with reinforced insulation from any hazardous voltages, including the ac mains.
- One Vi pin and one Vo pin are to be grounded, or both the input and output pins are to be kept floating.
- The input pins of the module are not operator accessible.
- Another SELV reliability test is conducted on the whole system, as required by the safety agencies, on the combination of supply source and the subject module to verify that under a single fault, hazardous voltages do not appear at the module's output.

**Note:** Do not ground either of the input pins of the module without grounding one of the output pins. This may allow a non-SELV voltage to appear between the output pin and ground.

The power module has extra-low voltage (ELV) outputs when all inputs are ELV.

The input to these units is to be provided with a maximum 3 A normal-blow fuse in the ungrounded lead.



## Feature Descriptions

### Overcurrent Protection

To provide protection in a fault (output overload) condition, the unit is equipped with internal current-limiting circuitry and can endure current limiting for up to one second. If overcurrent exists for more than one second, the unit will shut down.

At the point of current-limit inception, the unit shifts from voltage control to current control. If the output voltage is pulled very low during a severe fault, the current-limit circuit can exhibit either foldback or tailout characteristics (output current decrease or increase).

The module is available in two overcurrent configurations. In one configuration, when the unit shuts down it will latch off. The overcurrent latch is reset by either cycling the input power or by toggling the ON/OFF pin for one second. In the other configuration, the unit will try to restart after shutdown. If the output overload condition still exists when the unit restarts, it will shut down again. This operation will continue indefinitely until the overcurrent condition is corrected.

### Remote On/Off

Negative logic remote on/off turns the module off during a logic high and on during a logic low. To turn the power module on and off, the user must supply a switch to control the voltage between the on/off terminal and the  $V_{I(-)}$  terminal ( $V_{on/off}$ ). The switch can be an open collector or equivalent (see Figure 16). A logic low is  $V_{on/off} = 0\text{ V}$  to  $1.2\text{ V}$ . The maximum  $I_{on/off}$  during a logic low is  $1\text{ mA}$ . The switch should maintain a logic-low voltage while sinking  $1\text{ mA}$ .

During a logic high, the maximum  $V_{on/off}$  generated by the power module is  $15\text{ V}$ . The maximum allowable leakage current of the switch at  $V_{on/off} = 15\text{ V}$  is  $50\text{ }\mu\text{A}$ .

If not using the remote on/off feature, short the ON/OFF pin to  $V_{I(-)}$ .

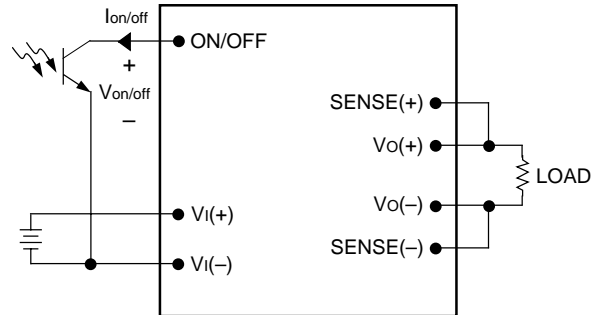

8-720 (C).c

Figure 16. Remote On/Off Implementation

### Remote Sense

Remote sense minimizes the effects of distribution losses by regulating the voltage at the remote-sense connections. The voltage between the remote-sense pins and the output terminals must not exceed the output voltage sense range given in the Feature Specifications table, i.e.:

$$[V_{o(+)} - V_{o(-)}] - [SENSE(+)-SENSE(-)] \leq 0.5\text{ V}$$

The voltage between the  $V_{o(+)}$  and  $V_{o(-)}$  terminals must not exceed the minimum output overvoltage protection value shown in the Feature Specifications table. This limit includes any increase in voltage due to remote-sense compensation and output voltage set-point adjustment (trim). See Figure 17.

If not using the remote-sense feature to regulate the output at the point of load, then connect SENSE(+) to  $V_{o(+)}$  and SENSE(-) to  $V_{o(-)}$  at the module.

Although the output voltage can be increased by both the remote sense and by the trim, the maximum increase for the output voltage is not the sum of both. The maximum increase is the larger of either the remote sense or the trim. Consult the factory if you need to increase the output voltage more than the above limitation.

The amount of power delivered by the module is defined as the voltage at the output terminals multiplied by the output current. When using remote sense and trim, the output voltage of the module can be increased, which at the same output current would increase the power output of the module. Care should be taken to ensure that the maximum output power of the module remains at or below the maximum rated power.

**Feature Descriptions** (continued)

**Remote On/Off** (continued)

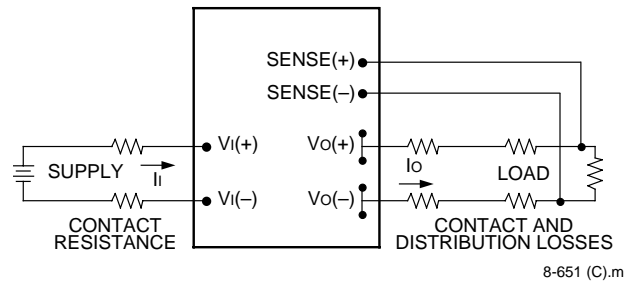

**Figure 17. Effective Circuit Configuration for Single-Module Remote-Sense Operation**

**Output Voltage Set-Point Adjustment (Trim)**

Output voltage trim allows the user to increase or decrease the output voltage set point of a module. This is accomplished by connecting an external resistor between the TRIM pin and either the SENSE(+) or SENSE(-) pins. The trim resistor should be positioned close to the module.

If not using the trim feature, leave the TRIM pin open.

With an external resistor between the TRIM and SENSE(-) pins ( $R_{adj-down}$ ), the output voltage set point ( $V_{O,adj}$ ) decreases (see Figure 18). The following equation determines the required external-resistor value to obtain a percentage output voltage change of  $\Delta\%$ .

$$R_{adj-down} = \left( \frac{510}{\Delta\%} - 10.2 \right) \text{ k}\Omega$$

The test results for this configuration are displayed in Figure 19. This figure applies to all output voltages.

With an external resistor connected between the TRIM and SENSE(+) pins ( $R_{adj-up}$ ), the output voltage set point ( $V_{O,adj}$ ) increases (see Figure 20).

The following equation determines the required external-resistor value to obtain a percentage output voltage change of  $\Delta\%$ .

$$R_{adj-up} = \left( \frac{5.1V_o(100 + \Delta\%)}{1.225\Delta\%} - \frac{510}{\Delta\%} - 10.2 \right) \text{ k}\Omega$$

The test results for this configuration are displayed in Figure 21.

The voltage between the  $V_o(+)$  and  $V_o(-)$  terminals must not exceed the minimum output overvoltage protection value shown in the Feature Specifications table. This limit includes any increase in voltage due to remote-sense compensation and output voltage set-

point adjustment (trim). See Figure 17.

Although the output voltage can be increased by both the remote sense and by the trim, the maximum increase for the output voltage is not the sum of both. The maximum increase is the larger of either the remote sense or the trim. Consult the factory if you need to increase the output voltage more than the above limitation.

The amount of power delivered by the module is defined as the voltage at the output terminals multiplied by the output current. When using remote sense and trim, the output voltage of the module can be increased, which at the same output current would increase the power output of the module. Care should be taken to ensure that the maximum output power of the module remains at or below the maximum rated power.

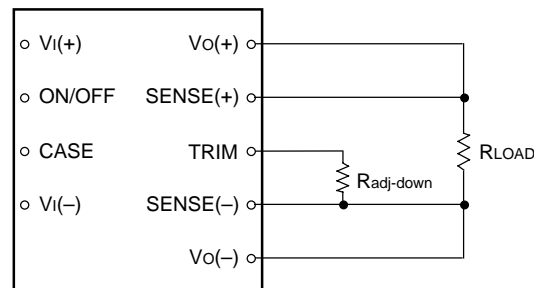

**Figure 18. Circuit Configuration to Decrease Output Voltage**

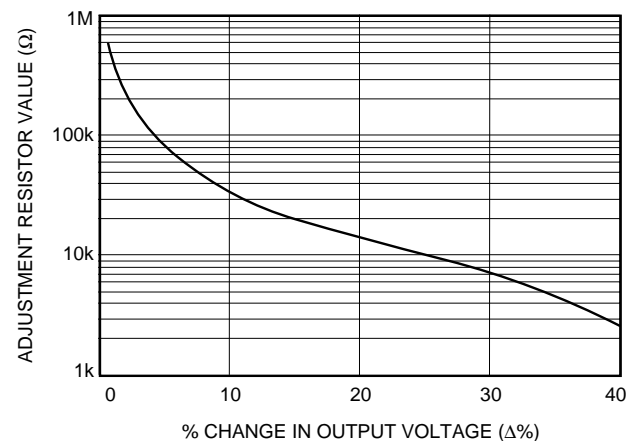

**Figure 19. Resistor Selection for Decreased Output Voltage**

**Feature Descriptions** (continued)

**Output Voltage Set-Point Adjustment (Trim)** (continued)

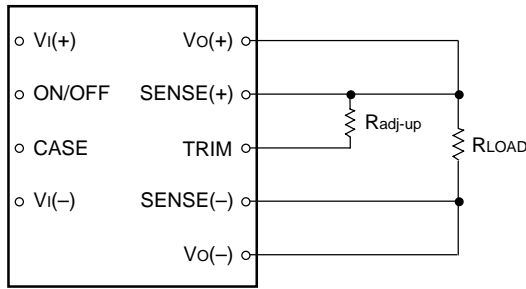

8-715 (C).b

**Figure 20. Circuit Configuration to Increase Output Voltage**

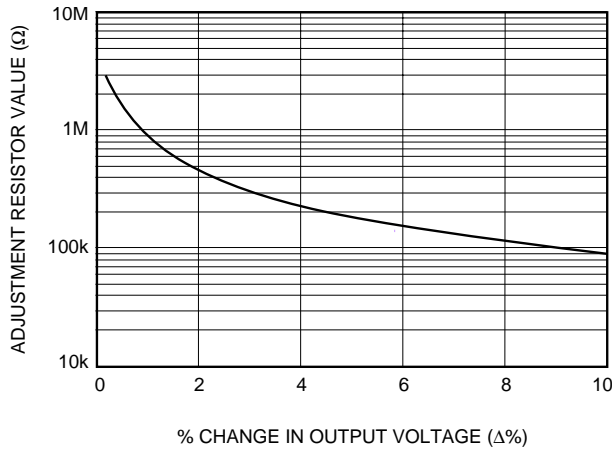

8-2580 (C)

**Figure 21. Resistor Selection for Increased Output Voltage**

**Output Overvoltage Protection**

The output overvoltage protection consists of circuitry that monitors the voltage on the output terminals. If the voltage on the output terminals exceeds the overvoltage protection threshold, then the module will shut down and latch off. The overvoltage latch is reset by either cycling the input power for 1.0 second or by toggling the on/off signal for 1.0 second.

**Overtemperature Protection**

These modules feature an overtemperature protection circuit to safeguard against thermal damage. The circuit shuts down and latches off the module when the maximum case temperature is exceeded. The module can be restarted by cycling the dc input power for at least 1.0 second or by toggling the primary or secondary referenced remote on/off signal for at least 1.0 second.

**Thermal Considerations**

**Introduction**

The power modules operate in a variety of thermal environments; however, sufficient cooling should be provided to help ensure reliable operation of the unit. Heat-dissipating components inside the unit are thermally coupled to the case. Heat is removed by conduction, convection, and radiation to the surrounding environment. Proper cooling can be verified by measuring the case temperature. Peak temperature ( $T_c$ ) occurs at the position indicated in Figure 22.

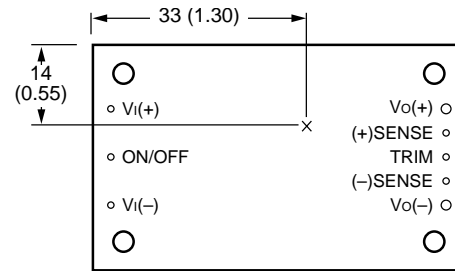

8-2104 (C)

Note: Top view, pin locations are for reference only. Measurements shown in millimeters and (inches).

**Figure 22. Case Temperature Measurement Location**

The temperature at this location should not exceed 100 °C. The output power of the module should not exceed the rated power for the module as listed in the Ordering Information table.

Although the maximum case temperature of the power modules is 100 °C, you can limit this temperature to a lower value for extremely high reliability.

**Thermal Considerations** (continued)

**Heat Transfer Without Heat Sinks**

Increasing airflow over the module enhances the heat transfer via convection. Figure 25 shows the maximum power that can be dissipated by the module without exceeding the maximum case temperature versus local ambient temperature ( $T_A$ ) for natural convection through 4 m/s (800 ft./min.).

Note that the natural convection condition was measured at 0.05 m/s to 0.1 m/s (10 ft./min. to 20 ft./min.); however, systems in which these power modules may be used typically generate natural convection airflow rates of 0.3 m/s (60 ft./min.) due to other heat dissipating components in the system. The use of Figure 25 is shown in the following example.

**Example**

What is the minimum airflow necessary for a QW050F1 operating at  $V_I = 54$  V, an output current of 10 A, and a maximum ambient temperature of 40 °C?

**Solution**

Given:  $V_I = 54$  V  
 $I_o = 10$  A  
 $T_A = 40$  °C

Determine  $P_D$  (Use Figure 23.):

$$P_D = 8.8 \text{ W}$$

Determine airflow ( $v$ ) (Use Figure 25.):

$$v = 1.1 \text{ m/s (220 ft./min.)}$$

**Note:** Pending improvement will lower the power dissipation and reduce the airflow needed.

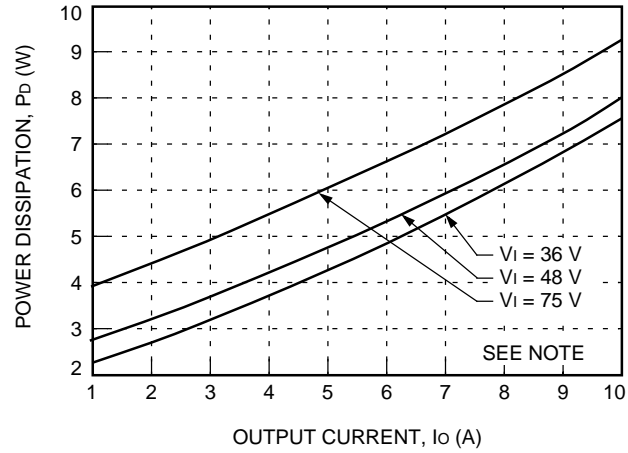

8-2967 (F)

Note: Pending improvement will lower the power dissipation.

**Figure 23. QW050F1 Power Dissipation vs. Output Current at Room Temperature**

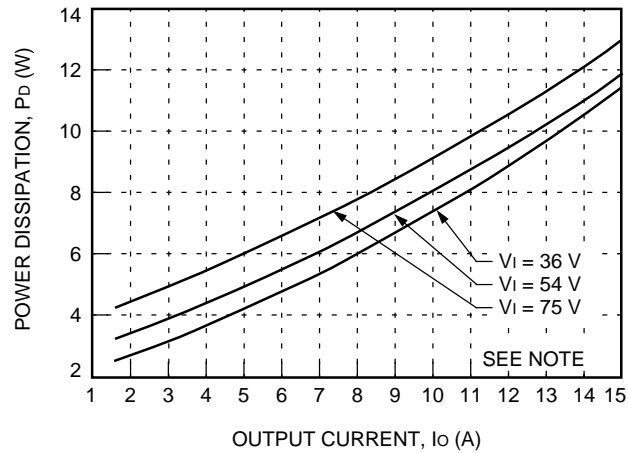

8-2968 (F)

Note: Pending improvement will lower the power dissipation.

**Figure 24. QW075F1 Power Dissipation vs. Output Current at Room Temperature**

**Thermal Considerations** (continued)

**Heat Transfer Without Heat Sinks**

(continued)

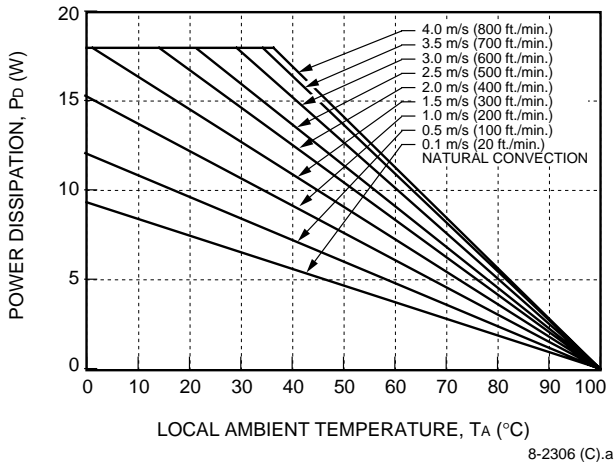

**Figure 25. Forced Convection Power Derating with No Heat Sink; Either Orientation**

**Heat Transfer with Heat Sinks**

The power modules have through-threaded, M3 x 0.5 mounting holes, which enable heat sinks or cold plates to attach to the module. The mounting torque must not exceed 0.56 N-m (5 in.-lb.). For a screw attachment from the pin side, the recommended hole size on the customer's PWB around the mounting holes is 0.130 ± 0.005 inches. If a larger hole is used, the mounting torque from the pin side must not exceed 0.25 N-m (2.2 in.-lbs.).

Thermal derating with heat sinks is expressed by using the overall thermal resistance of the module. Total module thermal resistance ( $\theta_{ca}$ ) is defined as the maximum case temperature rise ( $\Delta T_{c, max}$ ) divided by the module power dissipation ( $P_D$ ):

$$\theta_{ca} = \left[ \frac{\Delta T_{c, max}}{P_D} \right] = \left[ \frac{(T_C - T_A)}{P_D} \right]$$

The location to measure case temperature ( $T_C$ ) is shown in Figure 22. Case-to-ambient thermal resistance vs. airflow is shown, for various heat sink configurations and heights, in Figures 26 and 27. Longitudinal orientation is defined as the long axis of the module that is parallel to the airflow direction, whereas in the transverse orientation, the long axis is perpendicular to the airflow. These curves were obtained by experimental testing of heat sinks, which are offered in the product catalog.

Lucent Technologies Inc.

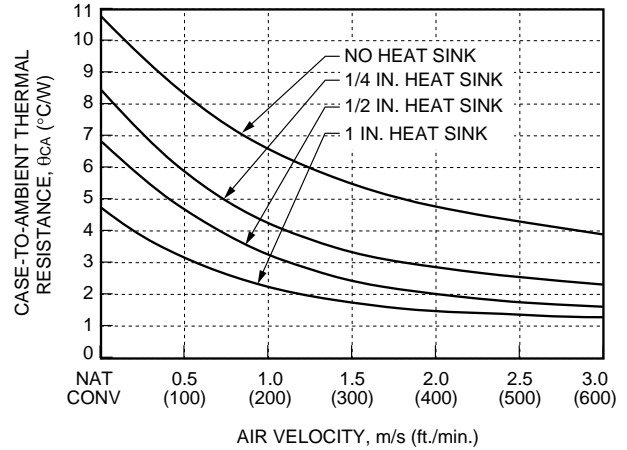

**Figure 26. Case-to-Ambient Thermal Resistance Curves; Transverse Orientation**

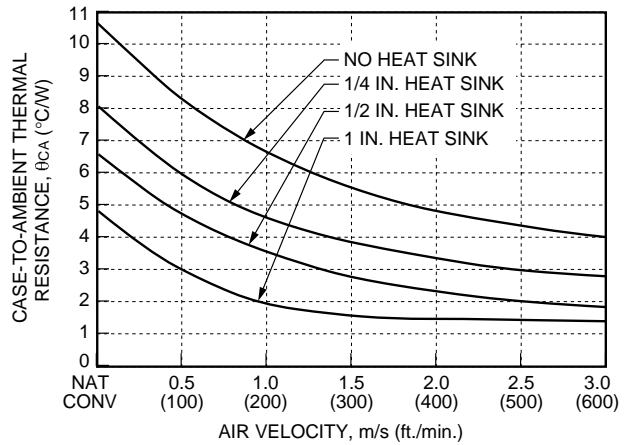

**Figure 27. Case-to-Ambient Thermal Resistance Curves; Longitudinal Orientation**

**Thermal Considerations** (continued)

**Heat Transfer with Heat Sinks** (continued)

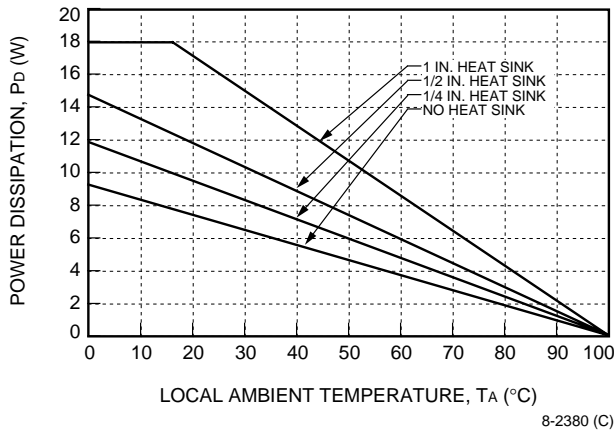

**Figure 28. Heat Sink Power Derating Curves;  
Natural Convection; Transverse  
Orientation**

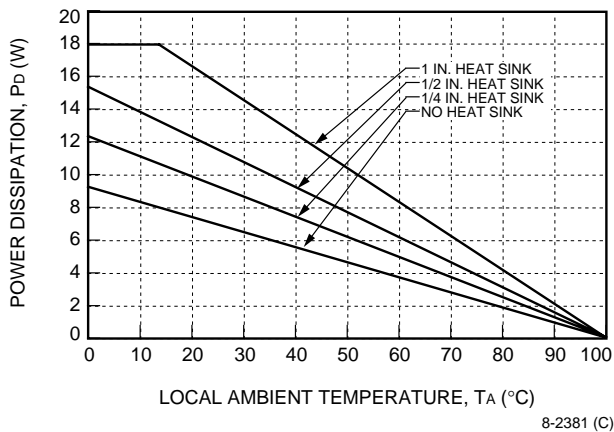

**Figure 29. Heat Sink Power Derating Curves;  
Natural Convection; Longitudinal  
Orientation**

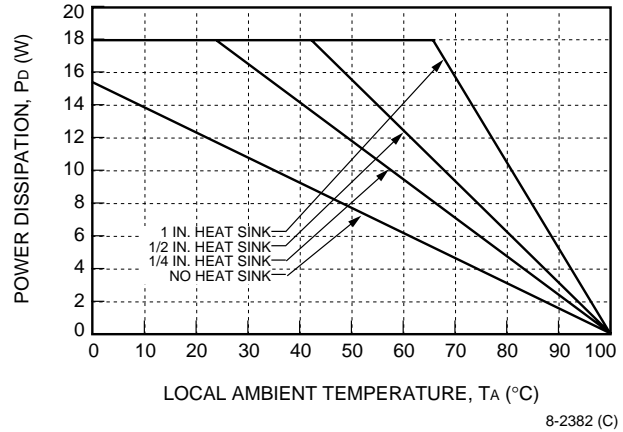

**Figure 30. Heat Sink Power Derating Curves;  
1.0 m/s (200 lfm); Transverse Orientation**

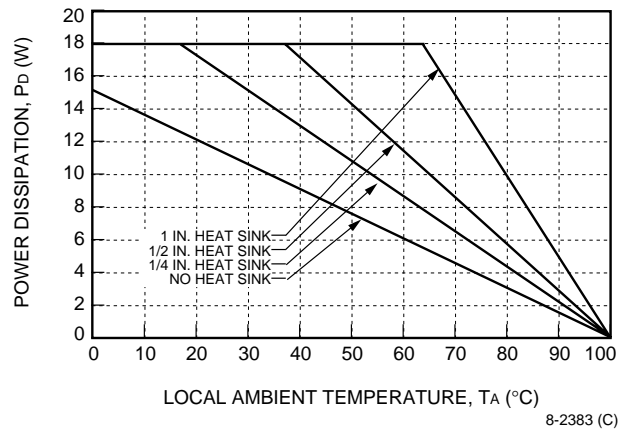

**Figure 31. Heat Sink Power Derating Curves;  
1.0 m/s (200 lfm); Longitudinal  
Orientation**

These measured resistances are from heat transfer from the sides and bottom of the module as well as the top side with the attached heat sink; therefore, the case-to-ambient thermal resistances shown are generally lower than the resistance of the heat sink by itself. The module used to collect the data in Figures 26 and 27 had a thermal-conductive dry pad between the case and the heat sink to minimize contact resistance. The use of Figures 26 and 27 are shown in the following example.

## Thermal Considerations (continued)

### Heat Transfer with Heat Sinks (continued)

#### Example

If an 85 °C case temperature is desired, what is the minimum airflow necessary? Assume the QW075F1 module is operating at  $V_I = 54$  V and an output current of 10 A, transverse orientation, maximum ambient air temperature of 40 °C, and the heat sink is 1/2 inch.

#### Solution

Given:  $V_I = 54$  V  
 $I_O = 10$  A  
 $T_A = 40$  °C  
 $T_C = 85$  °C  
 Heat sink = 1/2 inch

Determine  $P_D$  by using Figure 24:

$$P_D = 8.8 \text{ W}$$

Then solve the following equation:

$$\theta_{ca} = \left[ \frac{(T_C - T_A)}{P_D} \right]$$

$$\theta_{ca} = \left[ \frac{(85 - 40)}{8.8} \right]$$

$$\theta_{ca} = 5.1 \text{ °C/W}$$

Use Figure 26 to determine air velocity for the 1/2 inch heat sink.

The minimum airflow necessary for the QW050F1 module is 0.4 m/s (70 ft./min.).

**Note:** Pending improvement will lower the power dissipation and reduce the airflow needed.

## Custom Heat Sinks

A more detailed model can be used to determine the required thermal resistance of a heat sink to provide necessary cooling. The total module resistance can be separated into a resistance from case-to-sink ( $\theta_{cs}$ ) and sink-to-ambient ( $\theta_{sa}$ ) as shown in Figure 32.

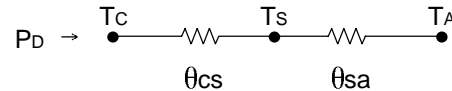

8-1304 (C)

**Figure 32. Resistance from Case-to-Sink and Sink-to-Ambient**

For a managed interface using thermal grease or foils, a value of  $\theta_{cs} = 0.1$  °C/W to 0.3 °C/W is typical. The solution for heat sink resistance is:

$$\theta_{sa} = \left[ \frac{(T_C - T_A)}{P_D} \right] - \theta_{cs}$$

This equation assumes that all dissipated power must be shed by the heat sink. Depending on the user-defined application environment, a more accurate model, including heat transfer from the sides and bottom of the module, can be used. This equation provides a conservative estimate for such instances.

## EMC Considerations

For assistance with designing for EMC compliance, please refer to the FLTR100V10 data sheet (DS99-294EPS).

## Layout Considerations

Copper paths must not be routed beneath the power module mounting inserts. For additional layout guidelines, refer to the FLTR100V10 data sheet (DS99-294EPS).

**Outline Diagram**

Dimensions are in millimeters and (inches).

Tolerances: x.x mm ± 0.5 mm (x.xx in. ± 0.02 in.)  
x.xx mm ± 0.25 mm (x.xxx in. ± 0.010 in.)

**Top View**

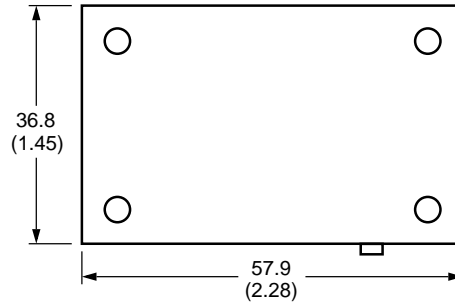

**Side View**

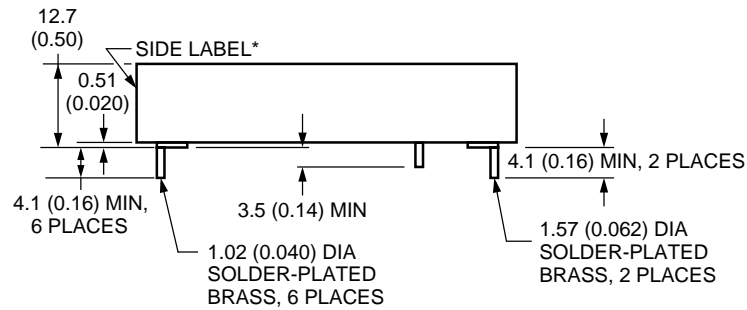

**Bottom View**

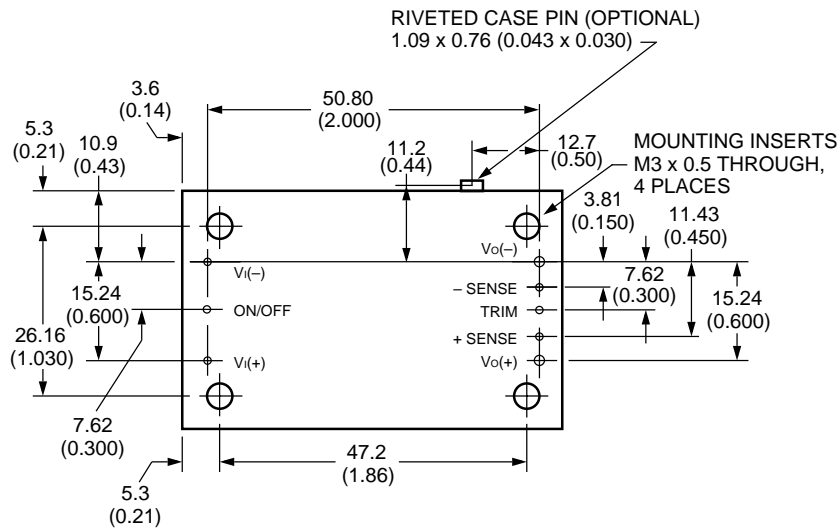

8-1769 (F).b

\* Side labels include Lucent logo, product designation, safety agency markings, input/output voltage and current ratings, and bar code.





**Ordering Information** (continued)

**Table 6. Device Accessories**

Accessory	Comcode
1/4 in. transverse kit (heat sink, thermal pad, and screws)	848060992
1/4 in. longitudinal kit (heat sink, thermal pad, and screws)	848061008
1/2 in. transverse kit (heat sink, thermal pad, and screws)	848061016
1/2 in. longitudinal kit (heat sink, thermal pad, and screws)	848061024
1 in. transverse kit (heat sink, thermal pad, and screws)	848061032
1 in. longitudinal kit (heat sink, thermal pad, and screws)	848061040

Dimensions are in millimeters and (inches).

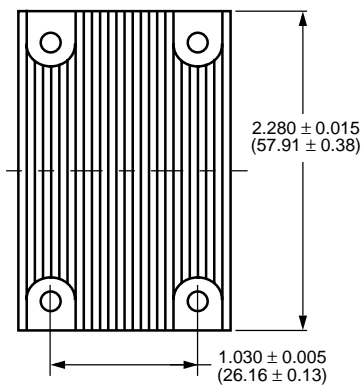

8-2473 (F)

**Figure 33. Longitudinal Heat Sink**

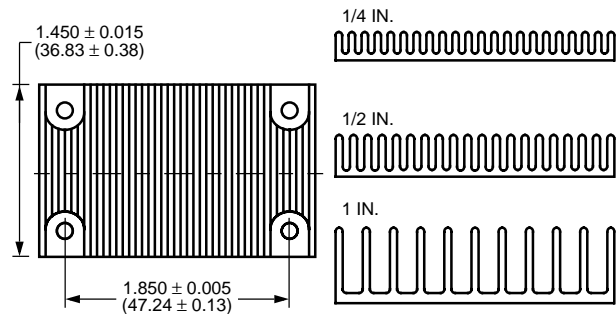

8-2472 (F)

**Figure 34. Transverse Heat Sink**

**Notes**

---

For additional information, contact your Lucent Technologies Account Manager or the following:

POWER SYSTEMS UNIT: Network Products Group, Lucent Technologies Inc., 3000 Skyline Drive, Mesquite, TX 75149, USA  
**+1-800-526-7819** (Outside U.S.A.: **+1-972-284-2626**, FAX +1-888-315-5182) (product-related questions or technical assistance)

INTERNET: **<http://www.lucent.com/networks/power>**  
E-MAIL: **[techsupport1@lucent.com](mailto:techsupport1@lucent.com)**

ASIA PACIFIC: Lucent Technologies Singapore Pte. Ltd., 750D Chai Chee Road #07-06, Chai Chee Industrial Park, Singapore 469004  
**Tel. (65) 240 8041**, FAX (65) 240 8438

CHINA: Lucent Technologies (China) Co. Ltd., SCITECH Place No. 22 Jian Guo Man Wai Avenue, Beijing 100004, PRC  
**Tel. (86) 10-6522 5566 ext. 4187**, FAX (86) 10-6512 3694

JAPAN: Lucent Technologies Japan Ltd., Mori Building No. 21, 4-33, Roppongi 1-chome, Minato-ku, Tokyo 106-8508, Japan  
**Tel. (81) 3 5561 5831**, FAX (81) 3 5561 1616

LATIN AMERICA: Lucent Technologies Inc., Room 416, 2333 Ponce de Leon Blvd., Coral Gables, FL 33134, USA  
**Tel. +1-305-569-4722**, FAX +1-305-569-3820

EUROPE: Technical Inquiries: GERMANY: **(49) 89 95086 0** (Munich), UNITED KINGDOM: **(44) 1344 865 900** (Ascot),  
FRANCE: **(33) 1 40 83 68 00** (Paris), SWEDEN: **(46) 8 594 607 00** (Stockholm),  
FINLAND: **(358) 9 4354 2800** (Helsinki), ITALY: **(39) 02 6608131** (Milan), SPAIN: **(34) 91 807 1441** (Madrid)

---

Lucent Technologies Inc. reserves the right to make changes to the product(s) or information contained herein without notice. No liability is assumed as a result of their use or application. No rights under any patent accompany the sale of any such product(s) or information.

