



QuickSwitch® Products High-Speed CMOS QuickSwitch 32:16 Mux/Demux

QS316233
QS3162233

FEATURES/BENEFITS

- Enhanced N channel FET with no inherent diode to V_{CC}
- 5Ω bidirectional switches connect inputs to outputs
- Zero propagation delay, zero ground bounce
- TTL-compatible input and output levels
- Undershoot clamp diodes on all switch and control pins
- Available in 56-pin SSOP and TSSOP
- QS3162233 is 25Ω version for low noise

APPLICATIONS

- Video, audio, graphics switching, muxing
- Hot-swapping, hot-docking (Application Note AN-13)
- Voltage translation (5V to 3.3V; Application Note AN-11)
- Bus funneling

DESCRIPTION

The QS316233 and QS3162233, each is a 32-bit to 16-bit high-speed CMOS, TTL-compatible switch which can multiplex or demultiplex data. It can be used for memory interleaving where two memory banks need to be addressed simultaneously. It can also be used as two 16-bit to 8-bit multiplexers or as one 32-bit to 16-bit multiplexer. SELn inputs control the data flow. TESTn inputs control either one or two ports connection. The QS3162233 adds an internal 25Ω series termination resistor to each switch to reduce reflection noise in high-speed applications.

Mux/Demux devices provide an order of magnitude faster speed than equivalent logic devices.

Figure 1. Functional Block Diagram

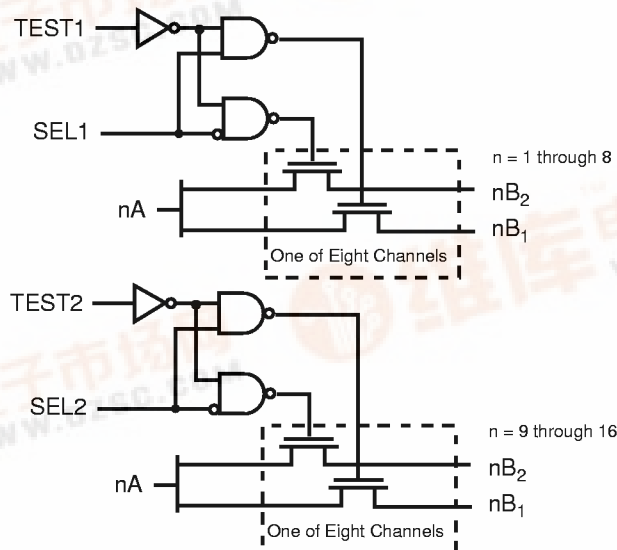

Table 1. Pin Description

Name	I/O	Function
nA	I/O	Bus A
nB ₁ , nB ₂	I/O	Bus B
SEL1, SEL2	I	Data select
TEST1, TEST2	I	Port select

Table 2. Function Table

n = 1 through 8

SEL1	TEST1	nA	Function
L	L	nB ₁	nA to nB ₁
H	L	nB ₂	nA to nB ₂
X	H	nB ₁ , nB ₂	nA to nB ₁ and nB ₂

n = 9 through 16

SEL2	TEST2	nA	Function
L	L	nB ₁	nA to nB ₁
H	L	nB ₂	nA to nB ₂
X	H	nB ₁ , nB ₂	nA to nB ₁ and nB ₂

Figure 2. Pin Configuration (All Pins Top View) SSOP(PV), TSSOP(PA)

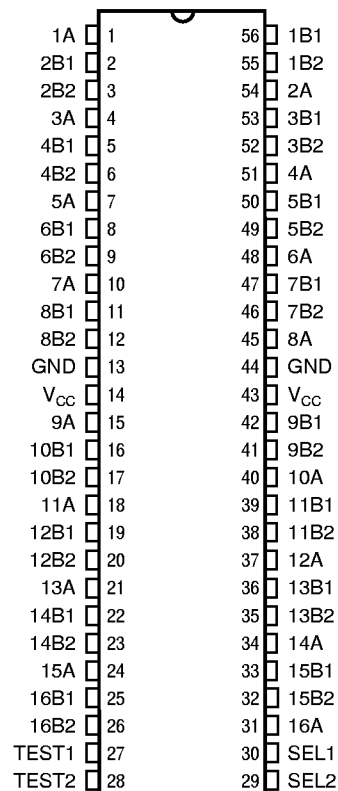

Table 3. Absolute Maximum Ratings

Supply Voltage to Ground	-0.5V to +7.0V
DC Switch Voltage V _S	-0.5V to +7.0V
DC Input Voltage V _{IN}	-0.5V to +7.0V
AC Input Voltage (for a pulse width ≤ 20ns)	-3.0V
DC Output Current Max. Sink Current/Pin	120mA
Maximum Power Dissipation At T _A = 85°C, SSOP	0.93 watts
TSSOP	0.77 watts
T _{STG} Storage Temperature	-65° to +150°C

Note: ABSOLUTE MAXIMUM CONTINUOUS RATINGS are those values beyond which damage to the device may occur. Exposure to these conditions or conditions beyond those indicated may adversely affect device reliability. Functional operation under absolute-maximum conditions is not implied.

Table 4. Capacitance

T_A = 25°C, f = 1MHz, V_{IN} = 0V, V_{OUT} = 0V

Pins		SSOP/TSSOP		Unit
		Typ	Max	
Control Inputs		5.0	5.5	pF
QuickSwitch Channels (Switch OFF)	Mux	8.5	10.0	pF
	Demux	6.0	7.0	pF

Note: Capacitance is guaranteed, but not tested. For total capacitance while the switch is ON, please see Section 1 under "Input and Switch Capacitance."

Table 5. DC Electrical Characteristics Over Operating Range $T_A = -40^{\circ}\text{C}$ to 85°C , $V_{CC} = 5.0\text{V} \pm 10\%$

Symbol	Parameter	Test Conditions	Min	Typ ⁽¹⁾	Max	Unit	
V_{IH}	Input HIGH Voltage	Guaranteed Logic HIGH for Control Inputs	2.0	—	—	V	
V_{IL}	Input LOW Voltage	Guaranteed Logic LOW for Control Inputs	—	—	0.8	V	
$ I_{IN} $	Input Leakage Current (Control Inputs)	$0 \leq V_{IN} \leq V_{CC}$	—	—	1	μA	
$ I_{OZ} $	Off-State Current (Hi-Z)	$0 \leq V_{OUT} \leq V_{CC}$	—	—	1	μA	
R_{ON}	Switch ON Resistance ⁽²⁾	$V_{CC} = \text{Min.}, V_{IN} = 0.0\text{V}$ $I_{ON} = 30\text{mA}$	QS316233	—	4	6	Ω
			QS3162233	20	28	40	
R_{ON}	Switch ON Resistance ⁽²⁾	$V_{CC} = \text{Min.}, V_{IN} = 2.4\text{V}$ $I_{ON} = 15\text{mA}$	QS316233	—	8	10	Ω
			QS3162233	20	35	48	
V_P	Pass Voltage ⁽³⁾	$V_{IN} = V_{CC} = 5\text{V}, I_{OUT} = -5\mu\text{A}$	3.7	4	4.2	V	

Notes:

- Typical values indicate $V_{CC} = 5.0\text{V}$ and $T_A = 25^{\circ}\text{C}$.
- For a diagram explaining the procedure for R_{ON} measurement, please see Section 1 under “DC Electrical Characteristics.” Max. value of R_{ON} guaranteed, but not production tested.
- Pass voltage is guaranteed, but not production tested.

5

Figure 3. Typical ON Resistance vs. V_{IN} at $V_{CC} = 5.0\text{V}$ (QS316233)**Note:** For QS3162233, add 23Ω to R_{ON} shown.

Table 6. Power Supply Characteristics Over Operating Range

$T_A = -40^{\circ}\text{C}$ to 85°C , $V_{CC} = 5.0\text{V} \pm 10\%$

Symbol	Parameter	Test Conditions ⁽¹⁾	Max	Unit
I_{CCQ}	Quiescent Power Supply Current	$V_{CC} = \text{Max.}$, $V_{IN} = \text{GND}$ or V_{CC} , $f = 0$	3.0	μA
ΔI_{CC}	Power Supply Current Per Control Input HIGH ⁽²⁾	$V_{CC} = \text{Max.}$, $V_{IN} = 3.4\text{V}$, $f = 0$	1.5	mA
Q_{CCD}	Dynamic Power Supply Current per MHz ⁽³⁾	$V_{CC} = \text{Max.}$, A and B Pins Open, Control Input Toggling @ 50% Duty Cycle	0.25	mA/MHz

Notes:

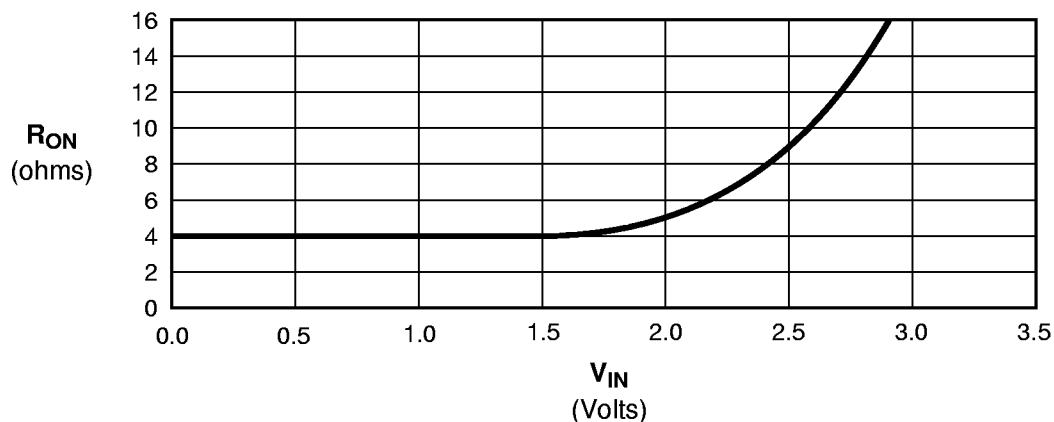
1. For conditions shown as Min. or Max., use the appropriate values specified under DC specifications.
2. Per TTL driven inputs ($V_{IN} = 3.4\text{V}$). A and B pins do not contribute to ΔI_{CC} .
3. This current applies to the control inputs only and represents the current required to switch internal capacitance at the specified frequency. The A and B inputs generate no significant AC or DC currents as they transition. This parameter is guaranteed, but not production tested.

Table 7. Switching Characteristics Over Operating Range

$T_A = -40^{\circ}\text{C}$ to 85°C , $V_{CC} = 5.0\text{V} \pm 10\%$

$C_{LOAD} = 50\text{pF}$, $R_{LOAD} = 500\Omega$ unless otherwise noted.

Symbol	Description ⁽¹⁾	QS316233			QS3162233			Unit
		Min	Typ	Max	Min	Typ	Max	
t_{PLH} t_{PHL}	Data Propagation Delay ^(2,4) nA to nBi, nBi to nA	—	—	0.25 ⁽³⁾	—	—	1.25 ⁽³⁾	ns
t_{BX}	Switch Multiplex Delay SEL to nA	1.5	—	5.3	1.5	—	6.5	ns
t_{PZL} t_{PZH}	Switch Turn-on Delay SEL, TEST to nBi	1.5	—	5.2	1.5	—	6.5	ns
t_{PLZ} t_{PHZ}	Switch Turn-off Delay ⁽²⁾ SEL, TEST to nBi	1.5	—	5.3	1.5	—	5.8	ns

Notes:

1. See Test Circuit and Waveforms. Minimums guaranteed, but not production tested.
2. This parameter is guaranteed, but not production tested.
3. The time constant for the switch alone is of the order of 0.25ns for QS316233 and 1.25ns for QS3162233 at $C_L = 50\text{pF}$.
4. The bus switch contributes no propagation delay other than the RC delay of the ON resistance of the switch and the load capacitance. Since this time constant is much smaller than the rise/fall times of typical driving signals, it adds very little propagation delay to the system. Propagation delay of the bus switch when used in a system is determined by the driving circuit on the driving side of the switch and its interaction with the load on the driven side.

**Selection Guide and
Packaging Information**

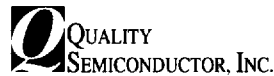

300-MIL SSOP - Package Code PV

Shrink Small Outline Package
Plastic Small Outline Gull-Wing

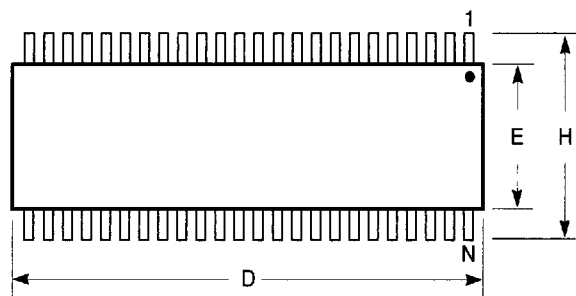

Notes:

1. Refer to applicable symbol list.
2. All dimensions are in inches.
3. N is the number of lead positions.
4. Dimensions D and E are to be measured at maximum material condition but do not include mold flash. Allowable mold flash is 0.006in. per side.
5. Lead coplanarity is 0.004in. maximum.

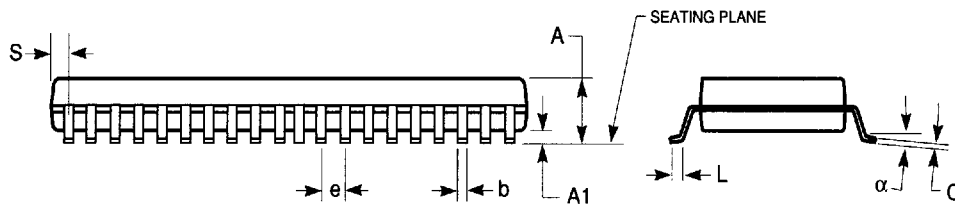

JEDEC#	MO-118AA			MO-118AB		
DWG#	PSS-48B			PSS-56B		
Symbol	Min	Nom	Max	Min	Nom	Max
A	0.095	0.102	0.110	0.095	0.102	0.110
A1	0.008	0.012	0.016	0.008	0.012	0.016
b	0.008	0.010	0.0135	0.008	0.010	0.0135
C	0.005	0.008	0.010	0.005	0.008	0.010
D	0.620	0.625	0.630	0.720	0.725	0.730
E	0.291	0.295	0.299	0.291	0.295	0.299
e	0.025 BSC			0.025 BSC		
H	0.395	0.410	0.420	0.395	0.410	0.420
L	0.020	0.030	0.040	0.020	0.030	0.040
N	48			56		
α	0°	5°	8°	0°	5°	8°
S	0.022	0.025	0.028	0.022	0.025	0.028

**Selection Guide and
Packaging Information**



240-MIL TSSOP - Package Code PA
Thin Shrink Small Outline Package
Plastic Small Outline Gull-Wing

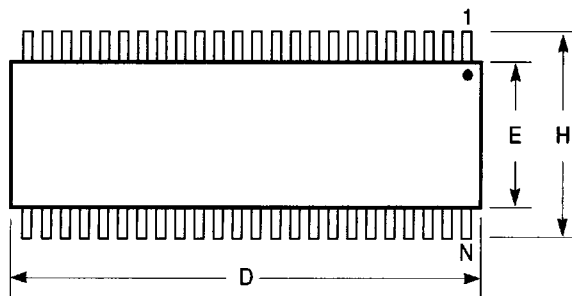

- Notes:**
1. Refer to applicable symbol list.
 2. N is the number of lead positions.
 3. Dimensions D, E, and S are to be measured at maximum material condition but do not include mold flash. Allowable mold flash is 0.006 in. per side.
 4. Lead coplanarity is 0.004in. maximum.

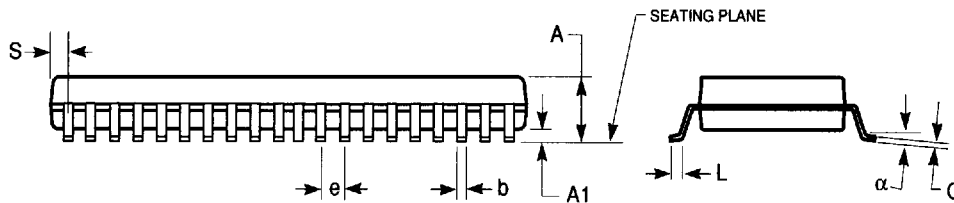

JEDEC#	MO-153ED			MO-153EE			MO-153ED			MO-153EE		
	PSS-48C			PSS-56C			PSS-48C			PSS-56C		
Symbol	Min	Nom	Max	Min	Nom	Max	Min	Nom	Max	Min	Nom	Max
A	0.039	0.043	0.047	0.039	0.043	0.047	1.00	1.10	1.20	1.00	1.10	1.20
A1	0.002	0.004	0.006	0.002	0.004	0.006	0.05	0.10	0.15	0.05	0.10	0.15
b	0.006	0.008	0.011	0.006	0.008	0.011	0.17	0.20	0.27	0.17	0.20	0.27
C	0.004	0.006	0.008	0.004	0.006	0.008	0.09	0.15	0.20	0.09	0.15	0.20
D	0.488	0.492	0.496	0.547	0.551	0.555	12.40	12.50	12.60	13.90	14.00	14.10
E	0.236	0.240	0.244	0.236	0.240	0.244	6.00	6.10	6.20	6.00	6.10	6.20
e	0.0197 BSC			0.0197 BSC			0.50 BSC			0.50 BSC		
H	0.315	0.319	0.323	0.315	0.319	0.323	8.00	8.10	8.20	8.00	8.10	8.20
L	0.018	0.024	0.030	0.018	0.024	0.030	0.45	0.60	0.75	0.45	0.60	0.75
N	48			56			48			56		
α	0°	5°	8°	0°	5°	8°	0°	5°	8°	0°	5°	8°
S	0.015	0.020	0.025	0.006	0.010	0.014	0.38	0.50	0.65	0.15	0.25	0.35

DIMENSIONS IN INCHES

DIMENSIONS IN MILLIMETERS