



QuickSwitch® Products High-Speed CMOS 24-Bit Bus-Exchange Switch

QS316212
QS3162212

FEATURES/BENEFITS

- Enhanced N channel FET with no inherent diode to V_{CC}
- 5Ω bidirectional switches connect inputs to outputs
- Zero propagation delay, zero ground bounce
- TTL-compatible input and output levels
- Undershoot Clamp diodes on all switch and control inputs
- Available in 56-pin SSOP and TSSOP
- QS3162212 is 25Ω version for low noise

APPLICATIONS

- Resource sharing
- Crossbar switching
- Hot-docking (Application Note AN-13)
- Voltage translation (5V to 3.3V; Application Note AN-11)

DESCRIPTION

The QS316212 and QS3162212 provide a set of twenty-four high-speed CMOS, TTL-compatible bus-exchange switches. The low ON resistance of the QS316212 allows inputs to be connected to outputs without adding propagation delay and without generating additional ground bounce noise. The device operates as a 24-bit bus switch or a 12-bit bus exchanger, which provides data exchanging between the four signal ports via the data-select (S0-S2) terminals.

The QS3162212 adds an internal 25Ω resistor to reduce reflection noise in high-speed applications. When the switch is closed, it acts as the source termination for the driver connected to it.

Figure 1. Functional Block Diagram

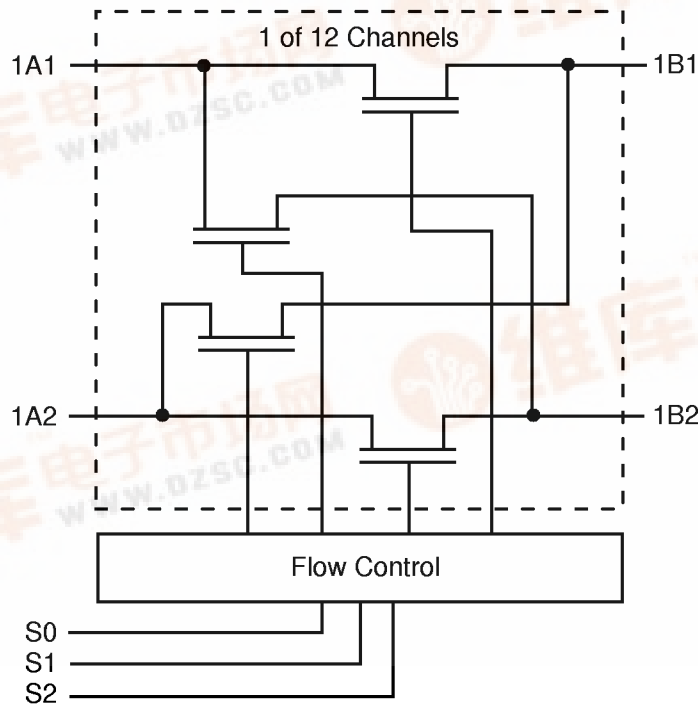
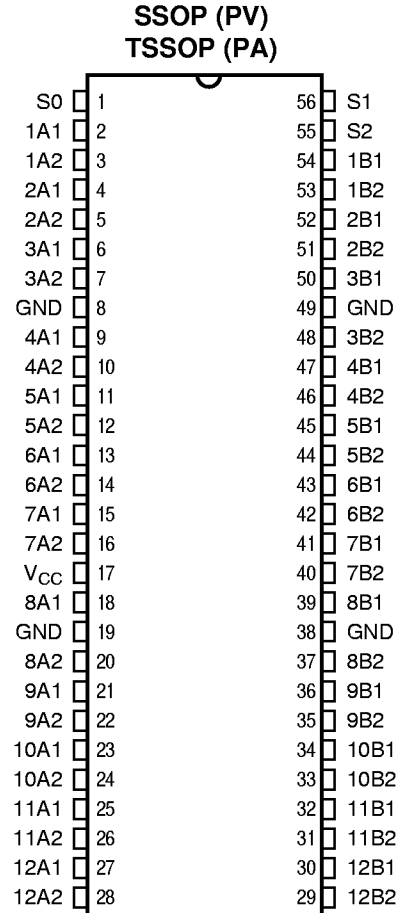

Table 1. Pin Description

Name	I/O	Function
1An-12An	I/O	Bus A
1Bn-12Bn	I/O	Bus B
S0 - S2	I	Data select

**Figure 2. Pin Configuration
(All Pins Top View)**



3

Table 2. Function Table

S2	S1	S0	iA1	iA2	Function
L	L	L	Z	Z	Disconnect
L	L	H	iB1	Z	iA1 to iB1
L	H	L	iB2	Z	iA1 to iB2
L	H	H	Z	iB1	iA2 to iB1
H	L	L	Z	iB2	iA2 to iB2
H	L	H	Z	Z	Disconnect
H	H	L	iB1	iB2	iA1 to iB1, iA2 to iB2
H	H	H	iB2	iB1	iA1 to iB2, iA2 to iB1

Table 3. Absolute Maximum Ratings

Supply Voltage to Ground	-0.5V to +7.0V
DC Switch Voltage V_S	-0.5V to +7.0V
DC Input Voltage V_{IN}	-0.5V to +7.0V
AC Input Voltage (for a pulse width ≤ 20 ns)	-3.0V
DC Output Current Max. Sink Current/Pin	120mA
Maximum Power Dissipation At $T_A = 85^\circ\text{C}$, SSOP	0.93 watts
TSSOP	0.77 watts
T_{STG} Storage Temperature	-65° to $+150^\circ\text{C}$

Note: ABSOLUTE MAXIMUM CONTINUOUS RATINGS are those values beyond which damage to the device may occur. Exposure to these conditions or conditions beyond those indicated may adversely affect device reliability. Functional operation under absolute-maximum conditions is not implied.

Table 4. Capacitance

$T_A = 25^\circ\text{C}$, $f = 1\text{MHz}$, $V_{IN} = 0\text{V}$, $V_{OUT} = 0\text{V}$

Pins	SSOP, TSSOP		Unit
	Typ	Max	
Control Inputs	4	5	pF
QuickSwitch Channels (Switch OFF)	7.5	9	pF

Note: Capacitance is guaranteed, but not production tested. For total capacitance while the switch is ON, please see Section 1 under "Input and Switch Capacitance."

Table 5. DC Electrical Characteristics Over Operating Range

$T_A = -40^{\circ}\text{C}$ to 85°C , $V_{CC} = 5.0\text{V} \pm 10\%$

Symbol	Parameter	Test Conditions	Min	Typ ⁽¹⁾	Max	Unit	
V_{IH}	Input HIGH Voltage	Guaranteed Logic HIGH for Control Inputs	2.0	—	—	V	
V_{IL}	Input LOW Voltage	Guaranteed Logic LOW for Control Inputs	—	—	0.8	V	
$ I_{IN} $	Input Leakage Current (Control Inputs)	$0 \leq V_{IN} \leq V_{CC}$	—	—	1	μA	
$ I_{OZ} $	Off-State Current (Hi-Z)	$0 \leq V_{OUT} \leq V_{CC}$, Switches OFF	—	—	1	μA	
R_{ON}	Switch ON Resistance ⁽²⁾	$V_{CC} = \text{Min.}, V_{IN} = 0.0\text{V}$ $I_{ON} = 30\text{mA}$	QS316212	—	4	6	Ω
			QS3162212	20	28	40	
R_{ON}	Switch ON Resistance ⁽²⁾	$V_{CC} = \text{Min.}, V_{IN} = 2.4\text{V}$ $I_{ON} = 15\text{mA}$	QS316212	—	8	12	Ω
			QS3162212	20	35	48	
V_P	Pass Voltage ⁽³⁾	$V_{IN} = V_{CC} = 5\text{V}, I_{OUT} = -5\mu\text{A}$	3.7	4	4.2	V	

Notes:

1. Typical values indicate $V_{CC} = 5.0\text{V}$ and $T_A = 25^{\circ}\text{C}$.
2. For a diagram explaining the procedure for R_{ON} measurement, please see Section 1 under “DC Electrical Characteristics.” Max. value of R_{ON} guaranteed, but not production tested.
3. Pass voltage is guaranteed, but not production tested.

Figure 3. Typical ON Resistance vs. V_{IN} at $V_{CC} = 5.0\text{V}$ (QS316212)

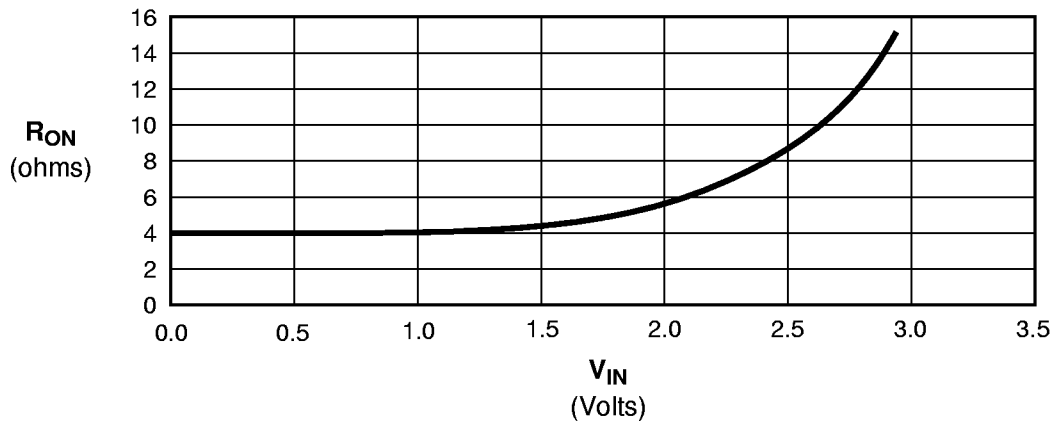

Note: For QS3162212, add 23Ω to R_{ON} shown.

Table 6. Power Supply Characteristics Over Operating Range $T_A = -40^\circ\text{C}$ to 85°C , $V_{CC} = 5.0\text{V} \pm 10\%$

Symbol	Parameter	Test Conditions ⁽¹⁾	Max	Unit
I_{CCQ}	Quiescent Power Supply Current	$V_{CC} = \text{Max.}$, $V_{IN} = \text{GND}$ or V_{CC} , $f = 0$	3.0	μA
ΔI_{CC}	Power Supply Current Per Control Input HIGH ⁽²⁾	$V_{CC} = \text{Max.}$, $V_{IN} = 3.4\text{V}$, $f = 0$	2.5	mA
Q_{CCD}	Dynamic Power Supply Current Per MHz ⁽³⁾	$V_{CC} = \text{Max.}$, A and B Pins Open, Control Input Toggling @ 50% Duty Cycle	0.25	mA/MHz

Notes:

1. For conditions shown as Min. or Max., use the appropriate values specified under DC specifications.
2. Per TTL driven input ($V_{IN} = 3.4\text{V}$). A and B pins do not contribute to ΔI_{CC} .
3. This current applies to the control inputs only and represents the current required to switch internal capacitance at the specified frequency. The A and B inputs generate no significant AC or DC currents as they transition. This parameter is guaranteed, but not production tested.

3

Table 7. Switching Characteristics Over Operating Range $T_A = -40^\circ\text{C}$ to 85°C , $V_{CC} = 5.0\text{V} \pm 10\%$ $C_{LOAD} = 50\text{pF}$, $R_{LOAD} = 500\Omega$ unless otherwise noted.

Symbol	Description ⁽¹⁾		Min	Typ	Max	Unit
t_{PLH}	Data Propagation Delay ^(2,4) iAn to iBn, iBn to iAn	QS316212	—	—	0.25 ⁽³⁾	ns
t_{PHL}		QS3162212	—	—	1.25	
t_{PZL}	Switch Turn-on Delay Sn to iAn, iBn	QS316212	1.5	—	6.5	ns
t_{PZH}		QS3162212	1.5	—	7.5	
t_{PLZ}	Switch Turn-off Delay ⁽²⁾ Sn to iAn, iBn	QS316212	1.5	—	6.2	ns
t_{PHZ}		QS3162212	1.5	—	6.8	

Notes:

1. See Test Circuit and Waveforms. Minimums guaranteed but not production tested.
2. This parameter is guaranteed, but not production tested.
3. The time constant for the switch alone is of the order of 0.25ns for QS316212 and 1.25 for QS3162212 for $C_L = 50\text{pF}$.
4. The bus switch contributes no propagation delay other than the RC delay of the ON resistance of the switch and the load capacitance. Since this time constant is much smaller than the rise/fall times of typical driving signals, it adds very little propagation delay to the system. Propagation delay of the bus switch when used in a system is determined by the driving circuit on the driving side of the switch and its interaction with the load on the driven side.

**Selection Guide and
Packaging Information**



300-MIL SSOP - Package Code PV

Shrink Small Outline Package
Plastic Small Outline Gull-Wing

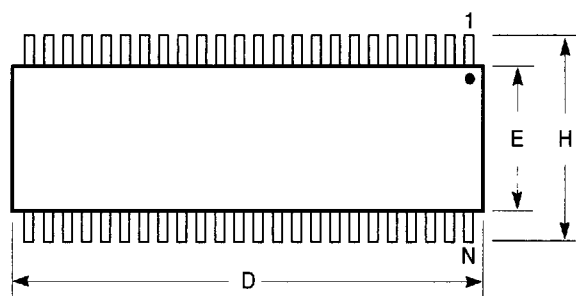

- Notes:**
1. Refer to applicable symbol list.
 2. All dimensions are in inches.
 3. N is the number of lead positions.
 4. Dimensions D and E are to be measured at maximum material condition but do not include mold flash. Allowable mold flash is 0.006in. per side.
 5. Lead coplanarity is 0.004in. maximum.

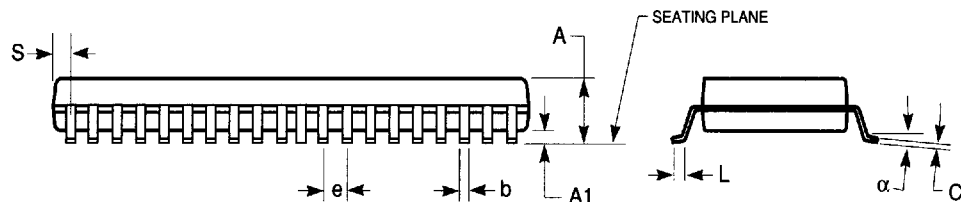

JEDEC#	MO-118AA			MO-118AB		
DWG#	PSS-48B			PSS-56B		
Symbol	Min	Nom	Max	Min	Nom	Max
A	0.095	0.102	0.110	0.095	0.102	0.110
A1	0.008	0.012	0.016	0.008	0.012	0.016
b	0.008	0.010	0.0135	0.008	0.010	0.0135
C	0.005	0.008	0.010	0.005	0.008	0.010
D	0.620	0.625	0.630	0.720	0.725	0.730
E	0.291	0.295	0.299	0.291	0.295	0.299
e	0.025 BSC			0.025 BSC		
H	0.395	0.410	0.420	0.395	0.410	0.420
L	0.020	0.030	0.040	0.020	0.030	0.040
N	48			56		
α	0°	5°	8°	0°	5°	8°
S	0.022	0.025	0.028	0.022	0.025	0.028

**Selection Guide and
Packaging Information**



240-MIL TSSOP - Package Code PA
Thin Shrink Small Outline Package
Plastic Small Outline Gull-Wing

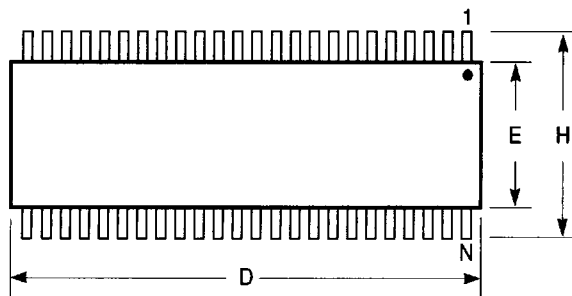

- Notes:**
1. Refer to applicable symbol list.
 2. N is the number of lead positions.
 3. Dimensions D, E, and S are to be measured at maximum material condition but do not include mold flash. Allowable mold flash is 0.006 in. per side.
 4. Lead coplanarity is 0.004in. maximum.

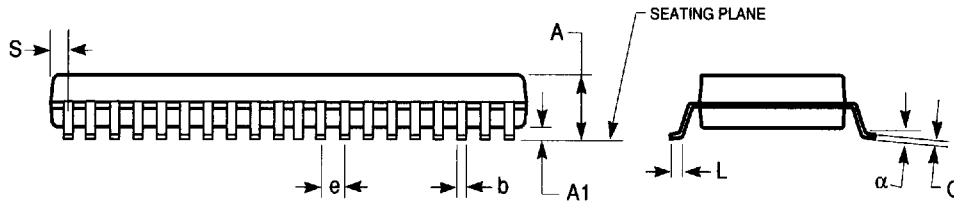

JEDEC#	MO-153ED			MO-153EE			MO-153ED			MO-153EE		
DWG#	PSS-48C			PSS-56C			PSS-48C			PSS-56C		
Symbol	Min	Nom	Max	Min	Nom	Max	Min	Nom	Max	Min	Nom	Max
A	0.039	0.043	0.047	0.039	0.043	0.047	1.00	1.10	1.20	1.00	1.10	1.20
A1	0.002	0.004	0.006	0.002	0.004	0.006	0.05	0.10	0.15	0.05	0.10	0.15
b	0.006	0.008	0.011	0.006	0.008	0.011	0.17	0.20	0.27	0.17	0.20	0.27
C	0.004	0.006	0.008	0.004	0.006	0.008	0.09	0.15	0.20	0.09	0.15	0.20
D	0.488	0.492	0.496	0.547	0.551	0.555	12.40	12.50	12.60	13.90	14.00	14.10
E	0.236	0.240	0.244	0.236	0.240	0.244	6.00	6.10	6.20	6.00	6.10	6.20
e	0.0197 BSC			0.0197 BSC			0.50 BSC			0.50 BSC		
H	0.315	0.319	0.323	0.315	0.319	0.323	8.00	8.10	8.20	8.00	8.10	8.20
L	0.018	0.024	0.030	0.018	0.024	0.030	0.45	0.60	0.75	0.45	0.60	0.75
N	48			56			48			56		
α	0°	5°	8°	0°	5°	8°	0°	5°	8°	0°	5°	8°
S	0.015	0.020	0.025	0.006	0.010	0.014	0.38	0.50	0.65	0.15	0.25	0.35

DIMENSIONS IN INCHES

DIMENSIONS IN MILLIMETERS