



M2147H HIGH SPEED 4096 x 1-BIT STATIC RAM *Military*

	M2147H-2	M2147H-3	M2147H
Max. Access Time (ns)	45	55	70
Max. Active Current (mA)	180	180	180
Max. Standby Current (mA)	30	30	30

- Pinout, Function, and Power Compatible to Industry Standard M2147**
- Direct Performance Upgrade for M2147**
- HMOS* II Technology**
- Power-Down**
- Completely Static Memory—No Clock or Timing Strobe Required**
- High Density 18-Pin Package**
- Equal Access and Cycle Times**
- Separate Data Input and Output**
- Single +5V Supply**
- Three-State Output**
- Military Temperature Range: -55°C to +125°C (T_C)**

The Intel M2147H is a 4096-bit static Random Access Memory organized as 4096 words by 1-bit using HMOS II, Intel's next generation high-performance MOS technology. It uses a uniquely innovative design approach which provides the ease-of-use features associated with non-clocked static memories and the reduced standby power dissipation associated with clocked static memories. To the user this means low standby power dissipation without the need for clocks, address setup and hold times, nor reduced data rates due to cycle times that are longer than access times.

\overline{CS} controls the power-down feature. In less than a cycle time after \overline{CS} goes high—deselecting the M2147H—the part automatically reduces its power requirements and remains in this low power standby mode as long as \overline{CS} remains high. This device feature results in system power savings as great as 85% in larger systems, where the majority of devices are deselected.

The M2147H is placed in an 18-pin package configured with the industry standard pinout. It is directly TTL compatible in all respects: inputs, output, and a single +5V supply. The data is read out nondestructively and has the same polarity as the input data. A data input and a separate three-state output are used.

*HMOS is a patented process of Intel Corporation.

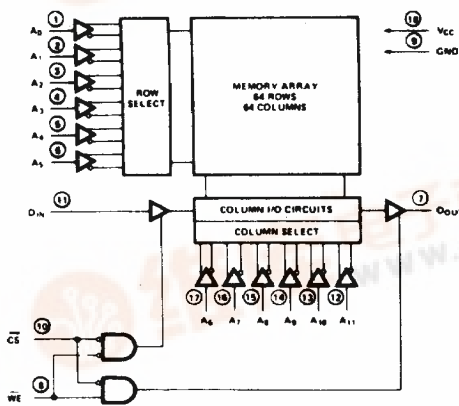

Figure 1. Block Diagram

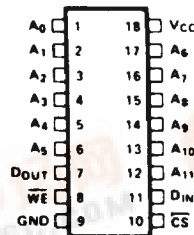

Figure 2. Pin Configuration

Truth Table

\overline{CS}	\overline{WE}	Mode	Output	Power
H	X	Not Selected	High Z	Standby
L	L	Write	High Z	Active
L	H	Read	D _{OUT}	Active

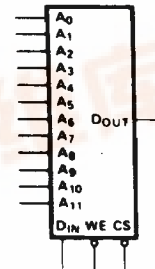

Figure 3. Logic Symbol

Pin Names

A ₀ -A ₁₁	Address Inputs
\overline{WE}	Write Enable
\overline{CS}	Chip Select
D _{IN}	Data Input
D _{OUT}	Data Output
V _{CC}	Power (+5V)
GND	Ground



ABSOLUTE MAXIMUM RATINGS*

Case Temperature Under Bias . . . -65°C to +135°C
 Storage Temperature -65°C to +150°C
 Voltage on Any Pin
 with Respect to Ground -3.5V to +7V
 Power Dissipation 1.2W
 D.C. Output Current 20 mA

NOTICE: This is a production data sheet. The specifications are subject to change without notice.

**WARNING: Stressing the device beyond the "Absolute Maximum Ratings" may cause permanent damage. These are stress ratings only. Operation beyond the "Operating Conditions" is not recommended and extended exposure beyond the "Operating Conditions" may affect device reliability.*

Operating Conditions

Symbol	Description	Min	Max	Units
T _C	Case Temperature (Instant On)	-55	+125	°C
V _{CC}	Digital Supply Voltage	4.50	5.50	V

D.C. CHARACTERISTICS (Over Specified Operating Conditions)

Symbol	Parameter	M2147H-2 M2147H-3, M2147H			Unit	Test Conditions
		Min	Typ(1)	Max		
I _{LI}	Input Load Current (All Input Pins)		0.01	10	μA	V _{CC} = Max., V _{IN} = GND to V _{CC}
I _{LO}	Output Leakage Current		0.1	50	μA	CS = V _{IH} , V _{CC} = Max., V _{OUT} = GND to 4.5V
I _{CC}	Operating Current		120	170	mA	T _C = 25°C
				180	mA	T _C = -55°C
I _{SB}	Standby Current		18	30	mA	V _{CC} = Min. to Max., CS = V _{IH} Outputs Open
I _{PO} (2)	Peak Power-On Current		35	70	mA	V _{CC} = GND to V _{CC} Min. CS = Lower of V _{CC} of V _{IH} Min.
V _{IL}	Input Low Voltage	-3.0		0.8	V	
V _{IH}	Input High Voltage	2.0		6.0	V	
V _{OL}	Output Low Voltage			0.4	V	I _{OL} = 8 mA
V _{OH}	Output High Voltage	2.4			V	I _{OH} = -4.0 mA
I _{OS}	Output Short Circuit Current	-275		+275	mA	V _{OUT} = GND to V _{CC} , T _C = 0°C

NOTES:

1. Typical limits at V_{CC} = 5V, T_C = +25°C, and Load A.
2. A pull-up resistor to V_{CC} on the CS input is required to keep the device deselected; otherwise, power-on current approaches I_{CC} active.

CAPACITANCE T_C = 25°C, F = 1.0 MHz

Symbol	Parameter	Max	Unit	Conditions
C _{IN}	Input Capacitance	5	pF	V _{IN} = 0V
C _{OUT}	Output Capacitance	6	pF	V _{OUT} = 0V

A.C. TEST CONDITIONS

- Input Pulse Levels GND to 3.0V
 Input Rise and Fall Times 5 ns
 Input Timing Reference Levels 1.5V
 Output Timing Reference Levels 0.8V-2.0V
 Output Load See Load A

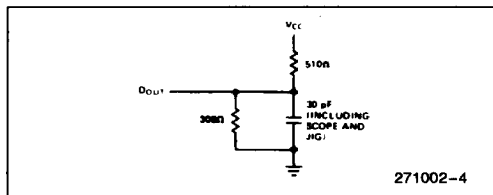

Load A

271002-4

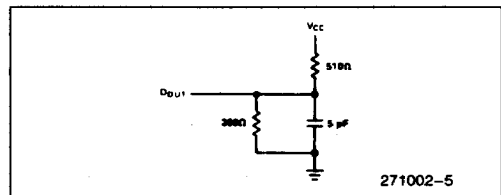

Load B

271002-5

A.C. CHARACTERISTICS (Over Specified Operating Conditions)

READ CYCLE

Symbol	Parameter	M2147H-2		M2147H-3		M2147H		Unit	Comments
		Min	Max	Min	Max	Min	Max		
$t_{RC}^{(1)}$	Read Cycle Time	45		55		70		ns	
t_{AA}	Address Access Time		45		55		70	ns	
t_{ACS1}	Chip Select Access Time		45		55		70	ns	(Note 7)
t_{ACS2}	Chip Select Access Time		45		65		80	ns	(Note 8)
t_{OH}	Output Hold from Address Change	5		5		5		ns	
$t_{LZ}^{(2)}$	Chip Selection to Output in Low Z	5		10		10		ns	(Note 3)
$t_{HZ}^{(2)}$	Chip Deselection to Output in High Z	0	30	0	30	0	40	ns	(Note 3)
t_{PU}	Chip Selection to Power Up Time	0		0		0		ns	
t_{PD}	Chip Deselection to Power Down Time		20		20		30	ns	

WAVEFORMS

READ CYCLE NO. 1(4, 5)

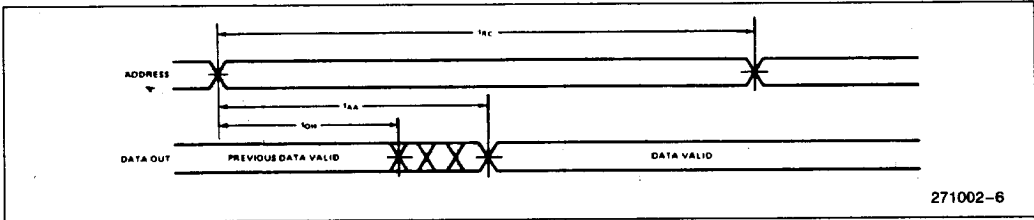

READ CYCLE NO. 2 (4, 6)

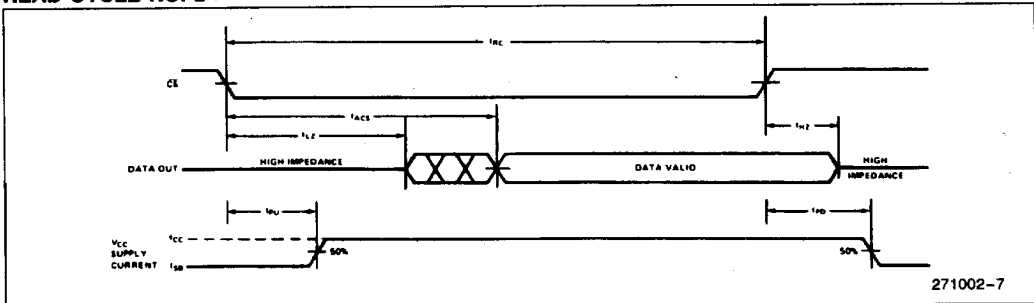

NOTES:

1. All Read Cycle timings are referenced from the last valid address to the first transitioning address.
2. At any given temperature and voltage condition, t_{HZ} max. is less than t_{LZ} min. both for a given device and from device to device.
3. Transition is measured ± 500 mV from steady state voltage with Load B.
4. WE is high for Read Cycles.
5. Device is continuously selected, $\overline{CS} = V_{IL}$.
6. Addresses valid prior to or coincident with \overline{CS} transition low.
7. Chip deselected for greater than 55 ns prior to selection.
8. Chip deselected for a finite time that is less than 55 ns prior to selection. (If the deselect time is 0 ns, the chip is by definition selected and access occurs according to Read Cycle No. 1.)

A.C. CHARACTERISTICS (Continued)

WRITE CYCLE

Symbol	Parameter	M2147H-2		M2147H-3		M2147H		Unit	Comments
		Min	Max	Min	Max	Min	Max		
$t_{WC}^{(2)}$	Write Cycle Time	45		55		70		ns	
t_{CW}	Chip Selection to End of Write	45		45		55		ns	
t_{AW}	Address Valid to End of Write	45		45		55		ns	
t_{AS}	Address Setup Time	0		0		0		ns	
t_{WP}	Write Pulse Width	25		25		40		ns	
t_{WR}	Write Recovery Time	0		10		15		ns	
t_{DW}	Data Valid to End of Write	25		25		30		ns	
t_{DH}	Data Hold Time	10		10		10		ns	
t_{WZ}	Write Enable to Output in High Z	0	25	0	25	0	35	ns	(Note 3)
t_{OW}	Output Active from End of Write	0		0		0		ns	(Note 3)

WAVEFORMS

WRITE CYCLE NO. 1 (\overline{WE} CONTROLLED) (4)

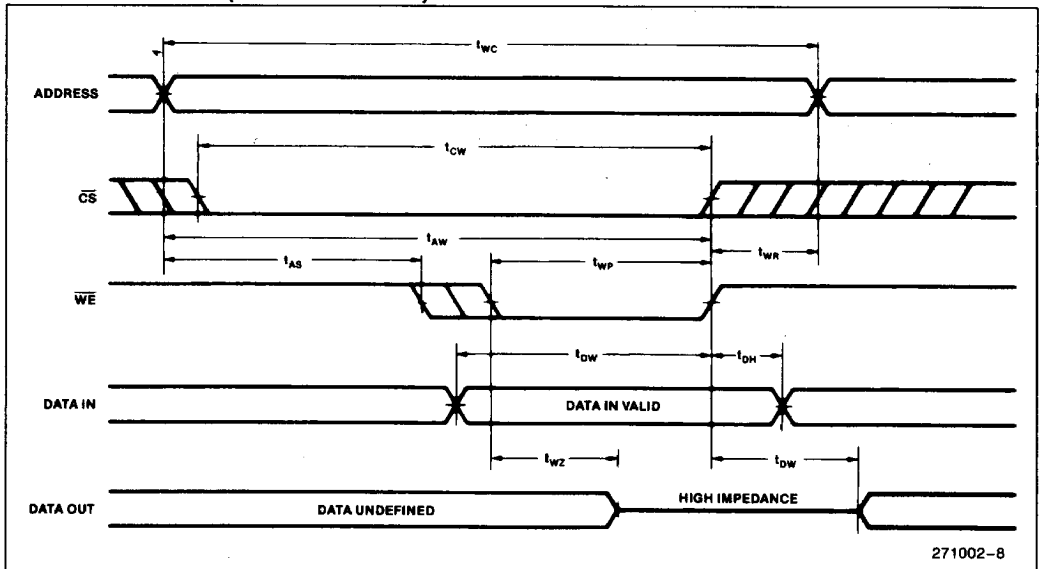

271002-8

WAVEFORMS (Continued)

WRITE CYCLE NO. 2 (\overline{CS} CONTROLLED) (4)

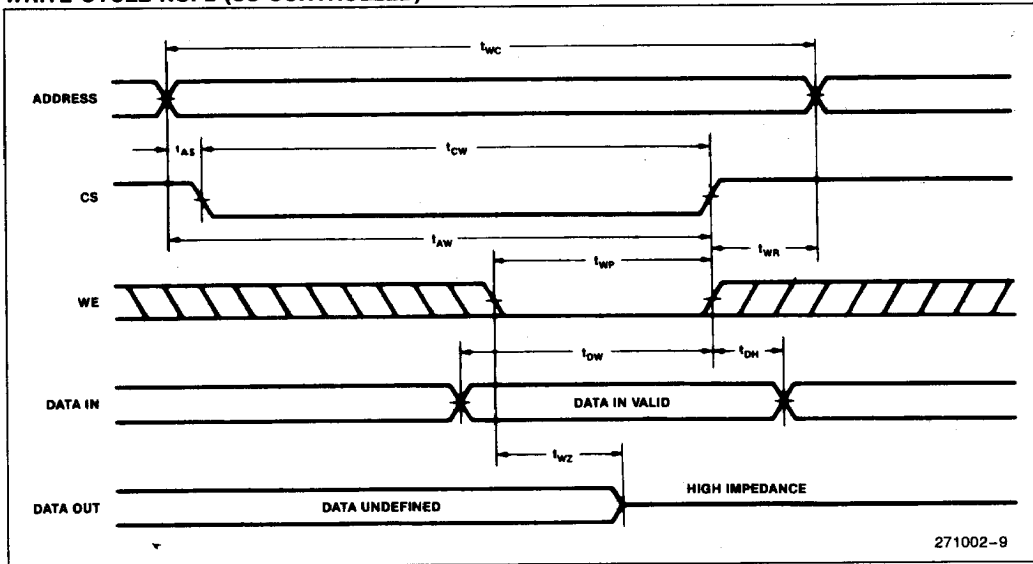

271002-9

NOTES:

1. If \overline{CS} goes high simultaneously with \overline{WE} high, the output remains in a high impedance state.
2. All Write Cycle timings are referenced from the last valid address to the first transitioning address.
3. Transition is measured ± 500 mV from steady state voltage with Load B.
4. \overline{CS} or \overline{WE} must be high during address transitions.