

Mounting Plates for Sockets

PYP-1

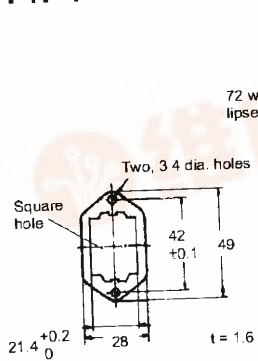

PYP-18

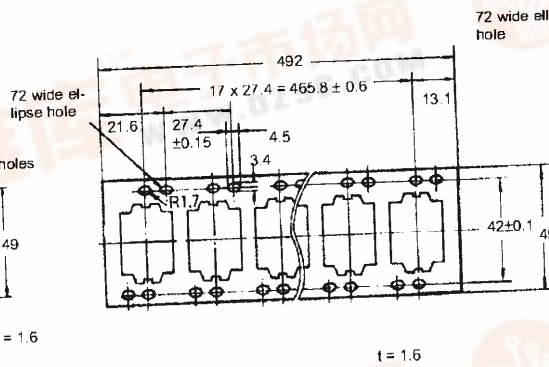

PYP-36

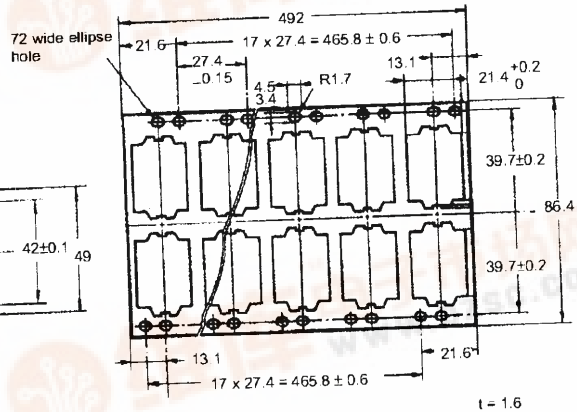

Hold-down Clips

Hold-down clips are used to hold relays to sockets and prevent them from coming loose due to vibration or shock.

Connection to socket		Connection to mounting plate		For relays with CR circuits	
PYC-A1	PYC-P	PYC-S	PYC-P2	Y92H-3	PYC-1

PY14-3 (for 4PDT)
with operation check terminal

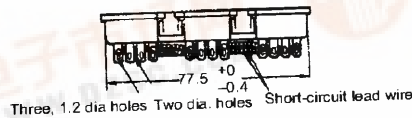
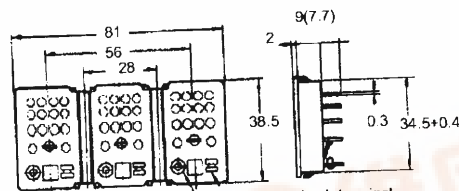
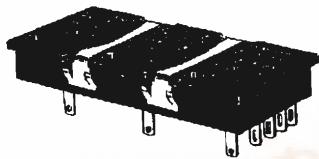

Mounting holes

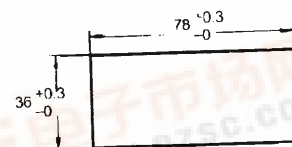

■ Safety Standards for Sockets

Item	Standards	File No.
PYF08A (-E), PYF11A	UL508	E87929
PYF14A (-E)	CSA22.2	LR31928