



EVERLIGHT ELECTRONICS CO., LTD.

DEVICE NUMBER : DPT-091-006 REV : 2.1
 ECN : _____ PAGE : 1/7

1.9mm Round Subminiature Axial Phototransistor

MODEL NO : PT91-21B

■ Features :

- Fast response time
- High photo sensitivity
- Small junction capacitance

■ Description :

PT91-21B is a phototransistor in miniature SMD package which is molded in a black transparent plastic with spherical top view lens .The device is spectrally matched to infrared emitting diode.

■ Applications :

- Optoelectronic switch
- VCR ,Video Camera
- Floppy disk drive
- Infrared applied system

PART NO.	CHIP	LENS COLOR
	MATERIAL	
PT	Silicon	Black





EVERLIGHT ELECTRONICS CO., LTD.

DEVICE NUMBER : DPT-091-006

REV : 2.1

ECN : _____

PAGE : 2/7

1.9mm Round Subminiature Axial Phototransistor

MODEL NO : PT91-21B

Package Dimensions :

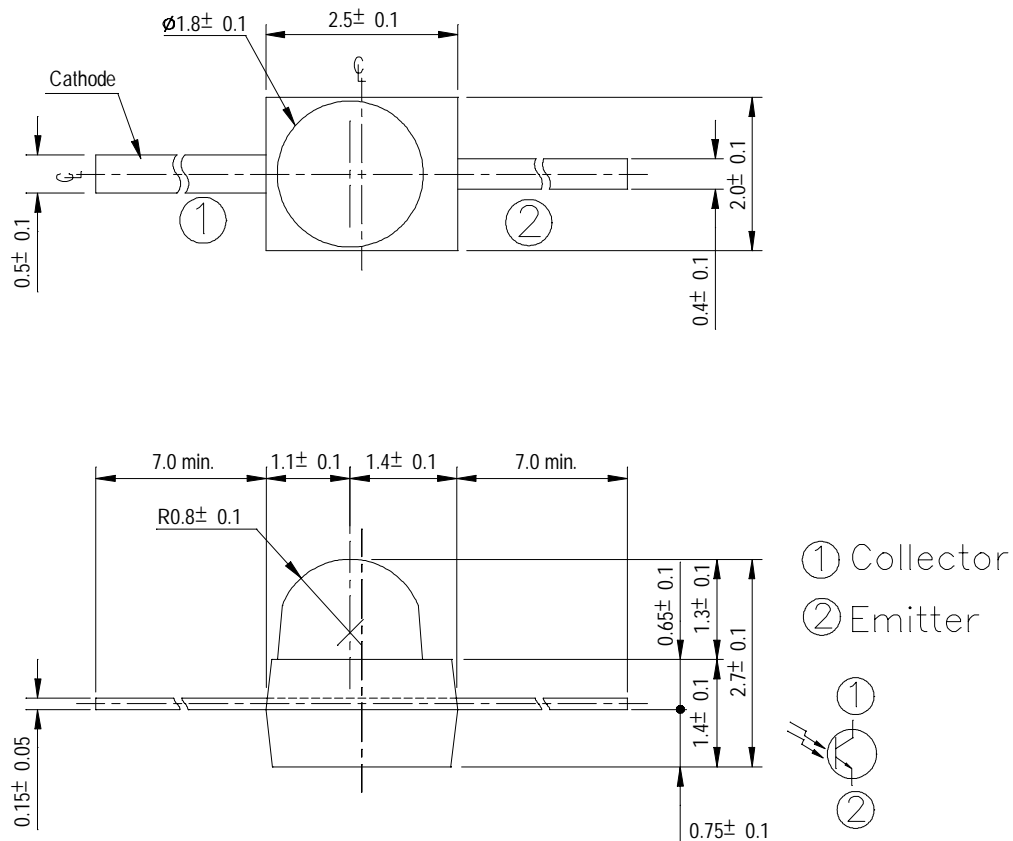

Notes :

1. All dimensions are in millimeter.
2. Lens color : Black transparent.
3. Above specification may be changed without notice. EVERLIGHT will reserve authority on material change for above specification.
4. These specification sheets include materials protected under copyright of EVERLIGHT corporation . Please don't reproduce or cause anyone to reproduce them without EVERLIGHT's consent.
5. When using this product , please observe the absolute maximum ratings and the instructions for use outlined in these specification sheets. EVERLIGHT assumes no responsibility for any damage resulting from use of the product which does not comply with the absolute maximum ratings and the instructions included in these specification sheets.



EVERLIGHT ELECTRONICS CO., LTD.

DEVICE NUMBER : DPT-091-006REV : 2.1

ECN : _____

PAGE : 3/7

1.9mm Round Subminiature Axial Phototransistor

MODEL NO : PT91-21B

■ Absolute Maximum Ratings at Ta = 25°C

Parameter	Symbol	Rating	Unit	Notice
Collector-Emitter Voltage	V_{CEO}	30	V	
Emitter-Collector-Voltage	V_{ECO}	5	V	
Collector Current	I_C	20	mA	
Operating Temperature	Topr	-25 ~ +85	°C	
Storage Temperature	Tstg	-40 ~ +85	°C	
Lead Soldering Temperature	Tsol	260	°C	
Power Dissipation at(or below) 25°C Free Air Temperature	Pc	75	mW	

■ Electronic Optical Characteristics :

Parameter	Symbol	Min.	Typ.	Max.	Unit	Condition
Collector-Emitter Breakdown Voltage	BV_{CEO}	30	----	----	V	$I_C=100\mu A$ $E_e=0mW/cm^2$
Emitter-Collector Breakdown Voltage	BV_{ECO}	5	----	----	V	$I_E=100\mu A$ $E_e=0mW/cm^2$
Collector-Emitter Saturation Voltage	$V_{CE(sat)}$	----	----	0.4	V	$I_C=2mA$ $E_e=1mW/cm^2$
Rise Time	t_r	----	15	----	μS	$V_{CE}=5V$ $I_C=1mA$ $R_L=1000\Omega$
Fall Time	t_f	----	15	----		
Collector Dark Current	I_{CEO}	----	----	100	nA	$E_e=0mW/cm^2$ $V_{CE}=20V$
On State Collector Current	$I_{C(on)}$	1.0	1.5	----	mA	$E_e=1mW/cm^2$ $V_{CE}=5V$
Wavelength of Peak Sensitivity	λ_p	----	980	----	nm	----
Rang of Spectral Bandwidth	$\lambda_{0.5}$	----	770--- 1200	----	nm	----



1.9mm Round Subminiature Axial Phototransistor

MODEL NO : PT91-21B

■ Typical Electrical/Optical/Characteristics Curves :

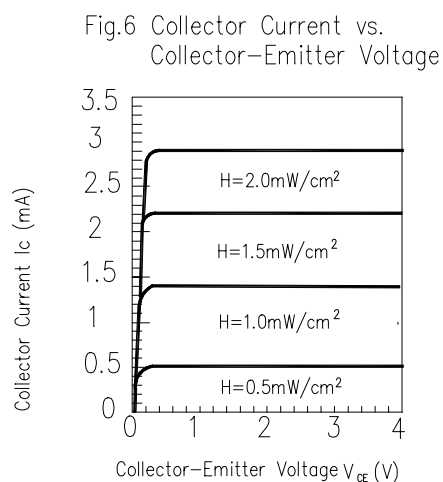
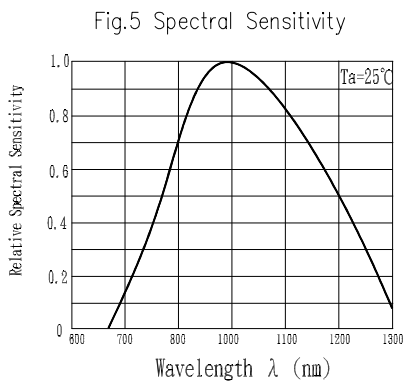
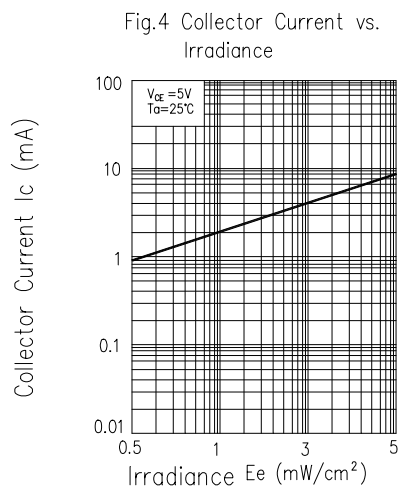
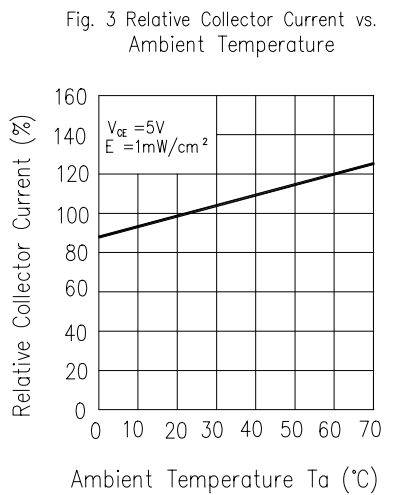
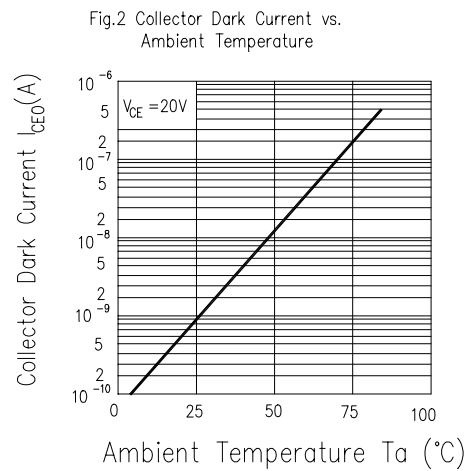
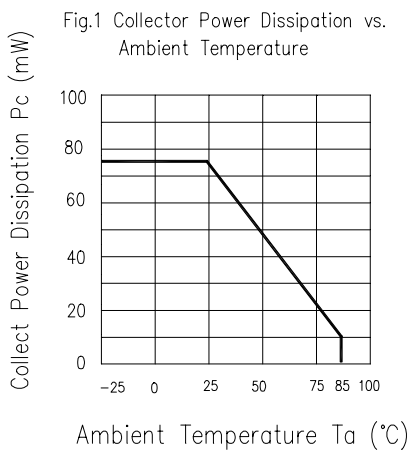



EVERLIGHT ELECTRONICS CO., LTD.

DEVICE NUMBER : DPT-091-006
ECN : _____

REV : 2.1
PAGE : 5/7

1.9mm Round Subminiature Axial Phototransistor

MODEL NO : PT91-21B

■ Reliability Test Item And Condition

The reliability of products shall be satisfied with items listed below.

Confidence level:90%

LTPD:10%

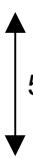
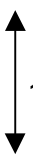
NO.	Item	Test Conditions	Test Hours/ Cycles	Sample Size	Failure Judgement Criteria	Ac/Re
1	REFLOW	TEMP : 240°C ± 5 °C 5 secs	6 mins	22 pcs	$I_{C(on)} \leq L \times 0.8$ L:Lower specification limit	0/1
2	Temperature Cycle	H : +85°C 30 mins  L : -55°C 30 mins	50 cycles	22 pcs		0/1
3	Thermal Shock	H : +100°C 5 mins  L : -10°C 5 mins	50 cycles	22 pcs		0/1
4	High Temperature Storage	TEMP. : +100°C	1000 hrs	22 pcs		0/1
5	Low Temperature Storage	TEMP. : -55°C	1000 hrs	22 pcs		0/1
6	DC Operating Life	$V_{CE}=5V$	1000 hrs	22 pcs		0/1
7	High Temperature / High Humidity	85°C / 85% R.H.	1000 hrs	22 pcs		0/1



EVERLIGHT ELECTRONICS CO., LTD.

DEVICE NUMBER : DPT-091-006

REV : 2.1

ECN : _____

PAGE : 6/7

1.9mm Round Subminiature Axial Phototransistor

MODEL NO : PT91-21B

■ Test Method For Reverse Light Current

Condition: $E_e=1\text{mW}/\text{cm}^2$, $V_{CE}=5\text{V}$

Test Item: Collector Current [$I_{C(on)}$]

(Unit: mA)

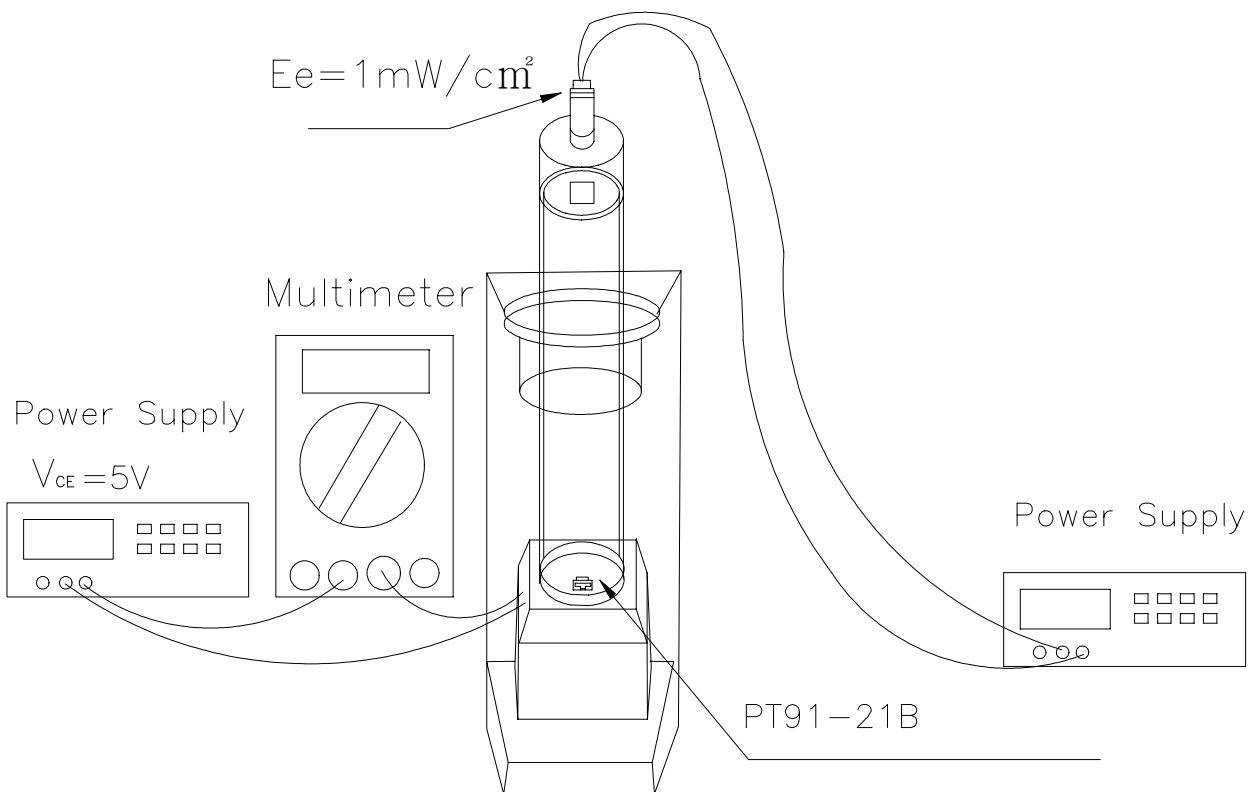



EVERLIGHT ELECTRONICS CO., LTD.

DEVICE NUMBER : DPT-091-006

REV : 2.1

ECN : _____

PAGE : 7/7

1.9mm Round Subminiature Axial Phototransistor

MODEL NO : PT91-21B

■ Packing Specifications

1. Bag

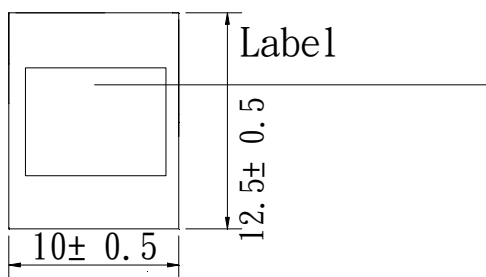

2. Box

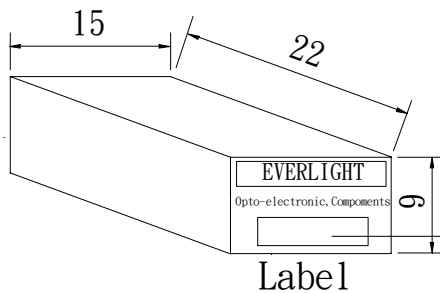

EVERLIGHT

CPN:

P/N:

PT91-21B

QTY:

LOT NO:

CAT:

HUE:

REF:

MADE IN TAIWAN

3. Carton

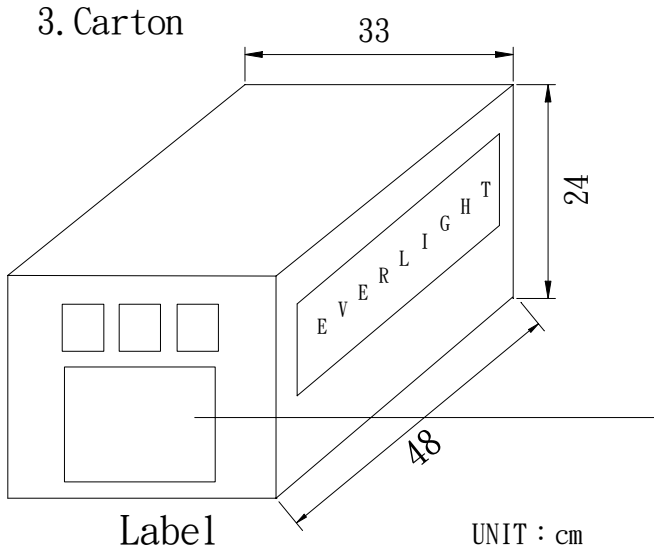

Label

UNIT : cm

CPN : Customer's Production Number

P/N : Production Number

QTY : Packing Quantity

CAT : Ranks

HUE : Peak Wavelength

REF : Reference

LOT NO : Lot Number

MADE IN TAIWAN : Production place

■ Packing Quantity Specification

1. 1000 Pcs/1Bag , 20 Bags/1Box

2. 10 Boxes/1Carton