

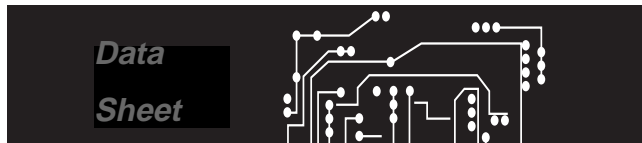

# PowerPC 403GA

## 32-Bit RISC

### Embedded Controller



#### Features

- PowerPC™ RISC CPU and instruction set architecture
- Glueless interfaces to DRAM, SRAM, ROM, and peripherals, including byte and half-word devices
- Separate instruction cache and write-back data cache, both two-way set-associative
- Minimized interrupt latency
- Individually programmable on-chip controllers for:
  - Four DMA channels
  - DRAM, SRAM, and ROM banks
  - Peripherals
  - Serial port
  - External interrupts
- Flexible interface to external bus masters
- Hardware multiplier and divider for faster integer arithmetic
- Thirty-two 32-bit general purpose registers

#### Applications

- Set-top boxes
- Consumer electronics and video games
- Telecommunications and networking
- Office automation (printers, copiers, fax machines)
- Personal digital assistants (PDA)

#### Specifications

- 25MHz, and 33MHz, and 40MHz versions
- Interfaces to both 3V and 5V technologies
- Low-power 3.3V operation with built-in power management and stand-by mode
- Low-cost 160 lead PQFP package
- 0.5 μm triple-level-metal CMOS

#### Overview

The PowerPC 403GA 32-bit RISC embedded controller offers high performance and functional integration with low power consumption. The 403GA RISC CPU executes at sustained speeds approaching one cycle per instruction. On-chip caches and integrated DRAM and SRAM control functions reduce chip count and design complexity in systems, while improving system throughput.

External I/O devices or SRAM/DRAM memory banks can be directly attached to the 403GA bus interface unit (BIU). Interfaces for up to eight memory banks and I/O devices, including a maximum of four DRAM banks, can be configured individually, allowing the BIU to manage devices or memory banks with differing control, timing, or bus width requirements.

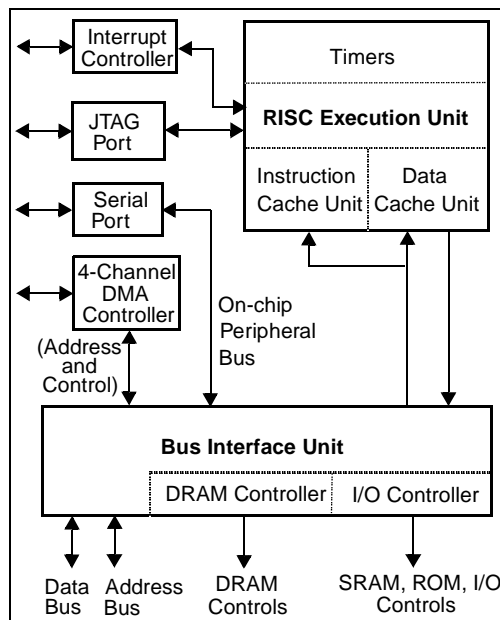

## IBM PowerPC 403GA

The 403GA RISC controller consists of a pipelined RISC processor core and several peripheral interface units: BIU, DMA controller, asynchronous interrupt controller, serial port, and JTAG debug port.

The RISC processor core includes the internal 2KB instruction cache and 1KB data cache, reducing overhead for data transfers to or from external memory. The instruction queue logic manages branch prediction, folding of branch and condition register logical instructions, and instruction prefetching to minimize pipeline stalls.

### RISC CPU

The RISC core comprises three tightly coupled functional units: the execution unit (EXU), the data cache unit (DCU), and the instruction cache unit (ICU). Each cache unit consists of a data array, tag array, and control logic for cache management and addressing. The execution unit consists of general purpose registers (GPR), special purpose registers (SPR), ALU, multiplier, divider, barrel shifter, and the control logic required to manage data flow and instruction execution within the EXU.

The EXU handles instruction decoding and execution, queue management, branch prediction, and branch folding. The instruction cache unit passes instructions to the queue in the EXU or, in the event of a cache miss, requests a fetch from external memory through the bus interface unit.

### General Purpose Registers

Data transfers to and from the EXU are handled through the bank of 32 GPRs, each 32 bits wide. Load and store instructions move data operands between the GPRs and the data cache unit, except in the cases of noncacheable data or cache misses. In such cases the DCU passes the address for the data read or write to the BIU. When noncacheable operands are being transferred, data can pass directly between the EXU and the BIU, which interfaces to the external memory being accessed.

### Special Purpose Registers

Special purpose registers are used to control debug facilities, timers, interrupts, the protection mechanism, memory cacheability, and other

architected processor resources. SPRs are accessed using move to/from special purpose register (mfspr/mfscr) instructions, which move operands between GPRs and SPRs.

Supervisory programs can write the appropriate SPRs to configure the operating and interface modes of the execution unit. The condition register (CR) and machine state register (MSR) are written by internal control logic with program execution status and machine state, respectively. Status of external interrupts is maintained in the external interrupt status register (EXISR). Fixed-point arithmetic exception status is available from the exception register (XER).

### Device Control Registers

Device control registers (DCR) are used to manage I/O interfaces, DMA channels, SRAM and DRAM memory configurations and timing, and status/address information regarding bus errors. DCRs are accessed using move to/from device control register (mtdcr/mfdcr) instructions, which move operands between GPRs and DCRs.

### Instruction Set

Table 1 summarizes the 403GA instruction set by categories of operations. Most instructions execute in a single cycle, with the exceptions of load/store multiple, load/store string, multiply, and divide instructions.

### Bus Interface Unit

The bus interface unit integrates the functional controls for data transfers and address operations other than those which the DMA controller handles. DMA transfers use the address logic in the BIU to output the memory addresses being accessed.

Control functions for direct-connect I/O devices and for DRAM, SRAM, or ROM banks are provided by the BIU. Burst access for SRAM, ROM, and page-mode DRAM devices is supported for cache fill and flush operations.

The BIU controls the transfer of data between the external bus and the instruction cache, the data cache, or registers internal to the processor core. The BIU also arbitrates among external bus master and DMA transfers, the internal buses to

the cache units and the register banks, and the serial port on the on-chip peripheral bus (OPB).

**Memory Addressing Regions**

The 403GA can address an effective range of four gigabytes, mapped to 3.5GB (256MB for SRAM/ROM or other I/O, 256MB DRAM, and 3GB OPB/reserved) of physical address space containing twenty-eight 128MB regions. Cacheability with respect to the instruction or data cache is programmed via the instruction and data cache control registers, respectively.

Within the DRAM and SRAM/ROM regions, a total of eight banks of devices are supported. Each bank supports direct attachment of memories up to 64 MB. Each bank can be configured for 8-, 16-, or 32-bit devices.

For individual DRAM banks, the number of wait states, bank size, RAS-to-CAS timing, use of an external address multiplexer (for external bus masters), and refresh rate are user-programmable. For each SRAM/ROM bank, the bank size, bank location, number of wait states, and timings of chip selects, byte enables, and output enables are all user-programmable.

**Instruction Cache Unit**

The instruction cache unit (ICU) is a two-way set-associative 2KB cache memory unit with enhancements to support branch prediction and folding. The ICU is organized as 64 sets of 2

lines, each line containing 16 bytes. A separate bypass path is available to handle cache-inhibited instructions and to improve performance during line fill operations.

The cache can send two cached instructions per cycle to the execution unit, allowing instructions to be folded out of the queue without interrupting normal instruction flow. When a branch instruction is folded and executed in parallel with another instruction, the ICU provides two more instructions to replace both of the instructions just executed so that bandwidth is balanced between the ICU and the execution unit.

**Data Cache Unit**

The data cache unit is provided to minimize the access time of frequently used data items in main store. The 1KB cache is organized as a two-way set associative cache. There are 32 sets of 2 lines, each line containing 16 bytes of data. The cache features byte-writeability to improve the performance of byte and halfword store operations.

Cache operations are performed using a write-back strategy. A write-back cache only updates locations in main storage that corresponds to changed locations in the cache. Data is flushed from the cache to main storage whenever changed data needs to be removed from the cache to make room for other data.

Table 1. 403GA Instructions by Category

Category	Base Instructions
Data Movement	load, store
Arithmetic / Logical	add, subtract, negate, multiply, divide, and, or, xor, nand, nor, xnor, sign extension, count leading zeros
Comparison	compare, compare logical, compare immediate
Branch	branch, branch conditional
Condition	condition register logical
Rotate/Shift	rotate, rotate and mask, shift left, shift right
Cache Control	invalidate, touch, zero, flush, store
Interrupt Control	write to external interrupt enable bit, move to/from machine state register, return from interrupt, return from critical interrupt
Processor Management	system call, synchronize, move to/from device control registers, move to/from special purpose registers

## IBM PowerPC 403GA

The data cache may be disabled for a 128MB memory region via control bits in the data cache control register or on a per-page basis if the MMU is enabled for data translation. A separate bypass path is available to handle cache-inhibited data operations and to improve performance during line fill operations.

Cache flushing and filling are triggered by load, store, and cache control instructions executed by the processor. Cache blocks are loaded starting at the requested fullword, continuing to the end of the block and then wrapping around to fill the remaining fullwords at the beginning of the block.

### DMA Controller

The four-channel DMA controller manages block data transfers in buffered, fly-by and memory-to-memory transfer modes with options for burst-mode operation. In fly-by and buffered modes, the DMA controller supports transactions between memory and peripheral devices.

Each DMA channel provides a control register, a source address register, a destination address register, a transfer count register, and a chained count register. Peripheral set-up cycles, wait cycles, and hold cycles can be programmed into each DMA channel control register. Each channel supports chaining operations. The DMA status register holds the status of all four channels.

### Exception Handling

Table 2 summarizes the 403GA exception priorities, types, and classes. Exceptions are generated by interrupts from internal and external peripherals, instructions, the internal timer facility, debug events or error conditions. Six external interrupt signals are provided on the 403GA: one critical and five general-purpose, all individually maskable.

All exceptions fall into three basic classes: asynchronous imprecise exceptions, synchronous precise exceptions, and asynchronous precise exceptions. Asynchronous exceptions are caused by events external to processor execution, while synchronous exceptions are caused by instructions.

Except for a system reset or machine check, all 403GA exceptions are handled precisely. Precise handling implies that the address of the excepting instruction (synchronous exceptions other than system call) or the address of the next sequential instruction (asynchronous exceptions and system call) is passed to the exception handling routine. Precise handling also implies that all instructions prior to the excepting instruction have completed execution and have written back their results.

Asynchronous imprecise exceptions include system resets and machine checks. Synchronous precise exceptions include most debug exceptions, program exceptions, protection violations, system calls, and alignment error exceptions. Asynchronous precise exceptions include the critical interrupt exception, external interrupts, and internal timer facility exceptions and some debug events.

Only one exception is handled at a time. If multiple exceptions occur simultaneously, they are handled in priority order.

The 403GA processes exceptions as reset, critical, or noncritical. Four exceptions are defined as critical: machine check exceptions, debug exceptions, exceptions caused by an active level on the critical interrupt pin, and the first time-out from the watchdog timer.

When a noncritical exception is taken, special purpose register Save/Restore 0 (SRR0) is loaded with the address of the excepting instruction (synchronous exceptions other than system call) or the next sequential instruction to be processed (asynchronous exceptions and system call). If the 403GA is executing a multicycle instruction (load/store multiple, load/store string, multiply or divide), the instruction is terminated and its address stored in SRR0. Save/Restore Register 1 (SRR1) is loaded with the contents of the machine state register. The MSR is then updated to reflect the new context of the machine. The new MSR contents take effect beginning with the first instruction of the exception handling routine.

At the end of the exception handling routine,

execution of a return from interrupt (rfi) instruction forces the contents of SRR0 and SRR1 to be loaded into the program counter and the MSR, respectively. Execution then begins at the address in the program counter.

The four critical exceptions are processed in a similar manner. When a critical exception is taken, SRR2 and SRR3 hold the next sequential address to be processed when returning from the exception and the contents of the machine state register, respectively. After the critical exception handling routine, return from critical interrupt (rfci) forces the contents of SRR2 and SRR3 to be loaded into the program counter and the MSR, respectively.

**Timers**

The 403GA contains four timer functions: a time base, a programmable interval timer (PIT), a fixed interval timer (FIT), and a watchdog timer. The time base is a 56-bit counter incremented at the timer clock rate. The timer clock may be driven by either an internal signal equal to the processor clock rate or by a separate external timer clock pin. No interrupts are generated when the time base rolls over.

The programmable interval timer is a 32-bit register that is decremented at the same rate as the time base is incremented. The user preloads the PIT register with a value to create the desired delay. When the register is decremented to

zeros, the timer stops decrementing, a bit is set in the timer status register (TSR), and a PIT interrupt is generated. Optionally, the PIT can be programmed to reload automatically the last value written to the PIT register, after which the PIT begins decrementing again. The timer control register (TCR) contains the interrupt enable for the PIT interrupt.

The fixed interval timer generates periodic interrupts based on selected bits in the time base. Users may select one of four intervals for the timer period by setting the correct bits in the TCR. When the selected bit in the time base changes from 0 to 1, a bit is set in the TSR and a FIT interrupt is generated. The FIT interrupt enable is contained in the TCR.

The watchdog timer generates a periodic interrupt based on selected bits in the time base. Users may select one of four time periods for the interval and the type of reset generated if the watchdog timer expires twice without an intervening clear from software. If enabled, the watchdog timer generates a system reset unless an exception handler updates the watchdog timer status bit before the timer has completed two of the selected timer intervals.

**Serial Port**

The 403GA serial port is capable of supporting

Table 2. 403GA Exception Priorities, Types and Classes

Priority	Exception Type	Exception Class
1	System Reset	Asynchronous imprecise
2	Machine Check	Asynchronous imprecise
3	Debug	Synchronous precise (except UDE and EXC)
4	Critical Interrupt	Asynchronous precise
5	WatchdogTimer Time-out	Asynchronous precise
6	Program Exception, Protection Violation, and System Calls	Synchronous precise
7	Alignment Exceptions	Synchronous precise
8	External Interrupts	Asynchronous precise
9	Fixed Interval Timer	Asynchronous precise
10	Programmable Interval Timer	Asynchronous precise

## IBM PowerPC 403GA

RS232 standard serial communication, as well as high-speed execution (bit speed at a maximum of one-sixteenth of the SysClk processor clock rate). The serial clock which drives the serial port can come from the internal SysClk or an external clock source at the external serial clock pin (maximum of one-half the SysClk rate).

The 403GA serial port contains many features found only on advanced communications controllers, including the capability of being a peripheral for DMA transfers. An internal loopback mode supports diagnostic testing without requiring external hardware. An auto echo mode is included to retransmit received bits to the external device. Auto-resynchronization after a line break and false start bit detection are also provided, as well as operating modes that allow the serial port to react to handshaking line inputs or control handshaking line outputs without software interaction. Program generation mode allows the serial port transmitter to be used for pulse width modulation with duty cycle variation controlled by frame size, baud rate, and data pattern.

### JTAG Port

The JTAG port has been enhanced to allow it to be used as a debug port. Through the JTAG test access port, debug software on a workstation or PC can single-step the processor and interrogate

internal processor state to facilitate software debugging. The standard JTAG boundary-scan register allows testing of circuitry external to the chip, primarily the board interconnect. Alternatively, the JTAG bypass register can be selected when no other test data register needs to be accessed during a board-level test operation.

### Real-Time Debug Port

The real-time debug port supports tracing the instruction stream being executed out of the instruction cache in real time. The trace status signals provide trace information while in real-time trace debug mode. This mode does not alter the performance of the processor.

### P/N Code

Table 3. PPC403GA Part Number

MHz	Part Number
25	PPC403GA-JC25C1
33	PPC403GA-JC33C1
40	PPC403GA-JC40C1

#### Notes:

1. The dash number indicates the speed version.
2. The characters in the dash number indicate package type (J), revision level (C), and commercial version (C).

Logic Symbol

Signals in brackets are multiplexed.

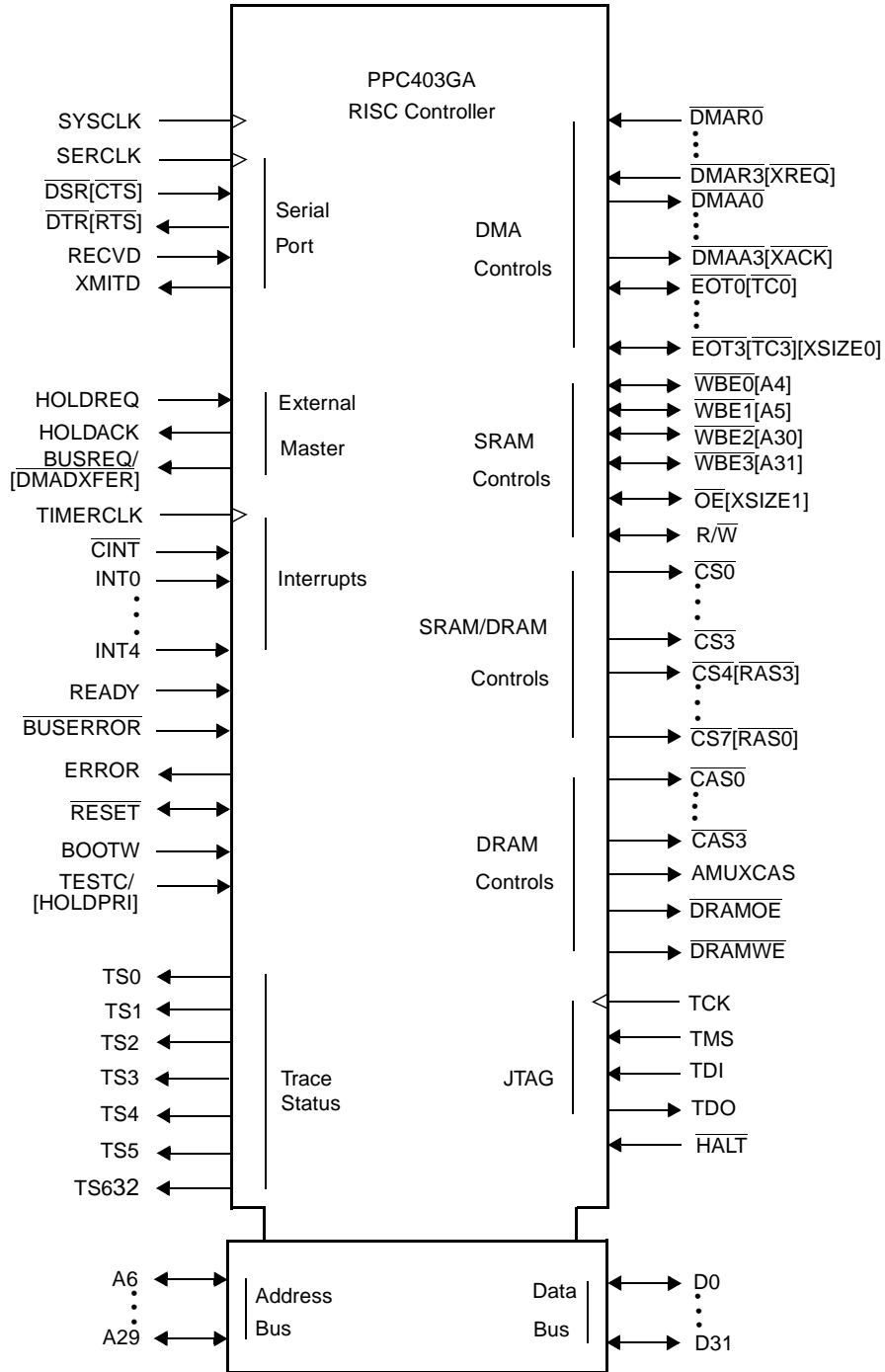

## IBM PowerPC 403GA

### Pin Functional Descriptions

Active-low signals are shown with overbars:  $\overline{\text{DMAR0}}$ . Multiplexed signals are alphabetized under the first (unmultiplexed) signal names on the same pins. The logic symbol on the preceding page shows all 403GA signals arranged by functional groups.

Table 4. 403GA Signal Descriptions

Signal Name	Pin	I/O Type	Function
A6	92	I/O	Address Bus Bit 6. When the 403GA is bus master, this is an address output from the 403GA. When the 403GA is not bus master, this is an address input from the external bus master, to determine bank register usage.
A7	93	I/O	Address Bus Bit 7. See description of A6.
A8	94	I/O	Address Bus Bit 8. See description of A6.
A9	95	I/O	Address Bus Bit 9. See description of A6.
A10	96	I/O	Address Bus Bit 10. See description of A6.
A11	97	I/O	Address Bus Bit 11. See description of A6.
A12	98	O	Address Bus Bit 12. When the 403GA is bus master, this is an address output from the 403GA.
A13	99	O	Address Bus Bit 13. See description of A12.
A14	103	O	Address Bus Bit 14. See description of A12.
A15	104	O	Address Bus Bit 15. See description of A12.
A16	105	O	Address Bus Bit 16. See description of A12.
A17	106	O	Address Bus Bit 17. See description of A12.
A18	107	O	Address Bus Bit 18. See description of A12.
A19	108	O	Address Bus Bit 19. See description of A12.
A20	109	O	Address Bus Bit 20. See description of A12.
A21	110	O	Address Bus Bit 21. See description of A12.
A22	112	I/O	Address Bus Bit 22. When the 403GA is bus master, this is an address output from the 403GA. When the 403GA is not bus master, this is an address input from the external bus master, to determine page crossings.
A23	113	I/O	Address Bus Bit 23. See description of A22.
A24	114	I/O	Address Bus Bit 24. See description of A22.
A25	115	I/O	Address Bus Bit 25. See description of A22.
A26	116	I/O	Address Bus Bit 26. See description of A22.
A27	117	I/O	Address Bus Bit 27. See description of A22.
A28	118	I/O	Address Bus Bit 28. See description of A22.



Table 4. 403GA Signal Descriptions

Signal Name	Pin	I/O Type	Function
A29	119	I/O	Address Bus Bit 29. See description of A22.
AMuxCAS	139	O	DRAM External Address Multiplexer Select. AMuxCAS controls the select logic on an external multiplexer. If AMuxCAS is low, the multiplexer should select the row address for the DRAM and when AMuxCAS is 1, the multiplexer should select the column address.
BootW	11	I	Boot-up ROM Width Select. BootW is sampled while the $\overline{\text{Reset}}$ pin is active and again after Reset becomes inactive to determine the width of the boot-up ROM. If this pin is tied to logic 0 when sampled on reset, an 8-bit boot width is assumed. If BootW is tied to 1, a 32-bit boot width is assumed. For 16-bit boot widths, this pin should be tied to the $\overline{\text{RESET}}$ pin.
$\overline{\text{BusError}}$	12	I	Bus Error Input. A logic 0 input to the $\overline{\text{BusError}}$ pin by an external device signals to the 403GA that an error occurred on the bus transaction. $\overline{\text{BusError}}$ is only sampled during the data transfer cycle or the last wait cycle of the transfer.
$\overline{\text{BusReq/DMADXFER}}$	135	O	Bus Request. While HoldAck is active, BusReq is active when the 403GA has a bus operation pending and needs to regain control of the bus. DMA Data Transfer. When HoldAck is not active, $\overline{\text{DMADXFER}}$ indicates a valid data transfer cycle. For DMA use, $\overline{\text{DMADXFER}}$ controls burst-mode fly-by DMA transfers between memory and peripherals. $\overline{\text{DMADXFER}}$ is not meaningful unless a DMA Acknowledge signal ( $\overline{\text{DMAA0:3}}$ ) is active. For transfer rates slower than one transfer per cycle, $\overline{\text{DMADXFER}}$ is active for one cycle when one transfer is complete and the next one starts. For transfer rates of one transfer per cycle, $\overline{\text{DMADXFER}}$ remains active throughout the transfer.
$\overline{\text{CAS0}}$	142	O	DRAM Column Address Select 0. $\overline{\text{CAS0}}$ is used with byte 0 of all DRAM banks.
$\overline{\text{CAS1}}$	143	O	DRAM Column Address Select 1. $\overline{\text{CAS1}}$ is used with byte 1 of all DRAM banks.
$\overline{\text{CAS2}}$	144	O	DRAM Column Address Select 2. $\overline{\text{CAS2}}$ is used with byte 2 of all DRAM banks.
$\overline{\text{CAS3}}$	145	O	DRAM Column Address Select 3. $\overline{\text{CAS3}}$ is used with byte 3 of all DRAM banks.
$\overline{\text{CINT}}$	36	I	Critical Interrupt. To initiate a critical interrupt, the user must maintain a logic 0 on the $\overline{\text{CINT}}$ pin for a minimum of one SysClk clock cycle followed by a logic 1 on the $\overline{\text{CINT}}$ pin for at least one SysClk cycle.
$\overline{\text{CS0}}$	155	O	SRAM Chip Select 0. Bank register 0 controls an SRAM bank, $\overline{\text{CS0}}$ is the chip select for that bank.
$\overline{\text{CS1}}$	154	O	SRAM Chip Select 1. See description of $\overline{\text{CS0}}$ but controls bank 1.

IBM PowerPC 403GA

Table 4. 403GA Signal Descriptions

Signal Name	Pin	I/O Type	Function
$\overline{CS2}$	153	O	SRAM Chip Select 2. See description of $\overline{CS0}$ but controls bank 2.
$\overline{CS3}$	152	O	SRAM Chip Select 3. See description of $\overline{CS0}$ but controls bank 3.
$\overline{CS4/RAS3}$	151	O	Chip Select 4/ DRAM Row Address Select 3. When bank register 4 is configured to control an SRAM bank, $\overline{CS4/RAS3}$ functions as a chip select. When bank register 4 is configured to control a DRAM bank, $\overline{CS4/RAS3}$ is the row address select for that bank.
$\overline{CS5/RAS2}$	148	O	Chip Select 5/ DRAM Row Address Select 2. See description of $\overline{CS4/RAS3}$ but controls bank 5.
$\overline{CS6/RAS1}$	147	O	Chip Select 6/ DRAM Row Address Select 1. See description of $\overline{CS4/RAS3}$ but controls bank 6.
$\overline{CS7/RAS0}$	146	O	Chip Select 7/ DRAM Row Address Select 0. See description of $\overline{CS4/RAS3}$ but controls bank 7.
D0	42	I/O	Data bus bit 0 (Most significant bit).
D1	43	I/O	Data bus bit 1.
D2	44	I/O	Data bus bit 2.
D3	45	I/O	Data bus bit 3.
D4	46	I/O	Data bus bit 4.
D5	47	I/O	Data bus bit 5.
D6	48	I/O	Data bus bit 6.
D7	51	I/O	Data bus bit 7.
D8	52	I/O	Data bus bit 8.
D9	53	I/O	Data bus bit 9.
D10	54	I/O	Data bus bit 10.
D11	55	I/O	Data bus bit 11.
D12	56	I/O	Data bus bit 12.
D13	57	I/O	Data bus bit 13.
D14	58	I/O	Data bus bit 14.
D15	62	I/O	Data bus bit 15.
D16	63	I/O	Data bus bit 16.
D17	64	I/O	Data bus bit 17.
D18	65	I/O	Data bus bit 18.
D19	66	I/O	Data bus bit 19.
D20	67	I/O	Data bus bit 20.
D21	68	I/O	Data bus bit 21.

Table 4. 403GA Signal Descriptions

Signal Name	Pin	I/O Type	Function
D22	71	I/O	Data bus bit 22.
D23	72	I/O	Data bus bit 23.
D24	73	I/O	Data bus bit 24.
D25	74	I/O	Data bus bit 25.
D26	75	I/O	Data bus bit 26.
D27	76	I/O	Data bus bit 27.
D28	77	I/O	Data bus bit 28.
D29	78	I/O	Data bus bit 29.
D30	79	I/O	Data bus bit 30.
D31	82	I/O	Data bus bit 31.
$\overline{\text{DMAA0}}$	156	O	DMA Channel 0 Acknowledge. $\overline{\text{DMAA0}}$ has an active level when a transaction is taking place between the 403GA and a peripheral.
$\overline{\text{DMAA1}}$	157	O	DMA Channel 1 Acknowledge. See description of $\overline{\text{DMAA0}}$ .
$\overline{\text{DMAA2}}$	158	O	DMA Channel 2 Acknowledge. See description of $\overline{\text{DMAA0}}$ .
$\overline{\text{DMAA3}}/\overline{\text{XACK}}$	159	O	DMA Channel 3 Acknowledge / External Master Transfer Acknowledge. When the 403GA is bus master, this signal is $\overline{\text{DMAA3}}$ ; see description of $\overline{\text{DMAA0}}$ . When the 403GA is not the bus master, this signal is $\overline{\text{XACK}}$ , an output from the 403GA which has an active level when data is valid during an external bus master transaction.
$\overline{\text{DMAR0}}$	2	I	DMA Channel 0 Request. External devices request a DMA transfer on channel 0 by putting a logic 0 on $\overline{\text{DMAR0}}$ .
$\overline{\text{DMAR1}}$	3	I	DMA Channel 1 Request. See description of $\overline{\text{DMAR0}}$ .
$\overline{\text{DMAR2}}$	4	I	DMA Channel 2 Request. See description of $\overline{\text{DMAR0}}$ .
$\overline{\text{DMAR3}}/\overline{\text{XREQ}}$	5	I	DMA Channel 3 Request. When the 403GA is the bus master, external devices request a DMA transfer on channel 3 by putting a logic 0 on $\overline{\text{DMAR3}}$ . See description of $\overline{\text{DMAR0}}$ . When the 403GA is not the bus master, $\overline{\text{DMAR3}}$ is used as the $\overline{\text{XREQ}}$ input. The external bus master places a logic 0 on $\overline{\text{XREQ}}$ to initiate a transfer to the DRAM controlled by the 403GA DRAM controller.
$\overline{\text{DRAMOE}}$	137	O	DRAM Output Enable. $\overline{\text{DRAMOE}}$ has an active level when either the 403GA or an external bus master is reading from a DRAM bank. This signal enables the selected DRAM bank to drive the data bus.
$\overline{\text{DRAMWE}}$	138	O	DRAM Write Enable. $\overline{\text{DRAMWE}}$ has an active level when either the 403GA or an external bus master is writing to a DRAM bank.

IBM PowerPC 403GA

Table 4. 403GA Signal Descriptions

Signal Name	Pin	I/O Type	Function
$\overline{\text{DSR}}/\overline{\text{CTS}}$	28	I	Data Set Ready / Clear to Send. The function of this pin as either $\overline{\text{DSR}}$ or $\overline{\text{CTS}}$ is selectable via the Serial Port Configuration bit in the IOCR.
$\overline{\text{DTR}}/\overline{\text{RTS}}$	88	O	Data Terminal Ready / Request to Send. The function of this pin as either $\overline{\text{DTR}}$ or $\overline{\text{RTS}}$ is selectable via the Serial Port Configuration bit in the IOCR.
$\overline{\text{EOT0}}/\overline{\text{TC0}}$	128	I/O	End of Transfer 0 / Terminal Count 0. The function of the $\overline{\text{EOT0}}/\overline{\text{TC0}}$ is controlled via the $\overline{\text{EOT}}/\overline{\text{TC}}$ bit in the DMA Channel 0 Control Register. When $\overline{\text{EOT0}}/\overline{\text{TC0}}$ is configured as an End of Transfer pin, external users may stop a DMA transfer by placing a logic 0 on this input pin. When configured as a Terminal Count pin, the 403GA signals the completion of a DMA transfer by placing a logic 0 on this pin.
$\overline{\text{EOT1}}/\overline{\text{TC1}}$	131	I/O	End of Transfer 1 / Terminal Count 1. See description of $\overline{\text{EOT0}}/\overline{\text{TC0}}$ .
$\overline{\text{EOT2}}/\overline{\text{TC2}}$	132	I/O	End of Transfer 2 / Terminal Count 2. See description of $\overline{\text{EOT0}}/\overline{\text{TC0}}$ .
$\overline{\text{EOT3}}/\overline{\text{TC3}}/\text{XSize0}$	133	I/O	End of Transfer 3 / Terminal Count 3 / External Master Transfer Size 0. When the 403GA is bus master, this pin has the same function as $\overline{\text{EOT0}}/\overline{\text{TC0}}$ . When the 403GA is not bus master, $\overline{\text{EOT3}}/\overline{\text{TC3}}/\text{XSize0}$ is used as one of two external transfer size input bits, XSize0:1.
Error	136	O	System Error. Error goes to a logic 1 whenever a machine check error is detected in the 403GA. The Error pin then remains a logic 1 until the machine check error is cleared in the Exception Syndrome Register and/or Bus Error Syndrome Register.

Table 4. 403GA Signal Descriptions

Signal Name	Pin	I/O Type	Function
GND	1		Ground. All ground pins must be used.
	10		Ground. All ground pins must be used.
	15		Ground. All ground pins must be used.
	29		Ground. All ground pins must be used.
	30		Ground. All ground pins must be used.
	41		Ground. All ground pins must be used.
	50		Ground. All ground pins must be used.
	59		Ground. All ground pins must be used.
	60		Ground. All ground pins must be used.
	70		Ground. All ground pins must be used.
	81		Ground. All ground pins must be used.
	90		Ground. All ground pins must be used.
	101		Ground. All ground pins must be used.
	102		Ground. All ground pins must be used.
	111		Ground. All ground pins must be used.
	121		Ground. All ground pins must be used.
130		Ground. All ground pins must be used.	
141		Ground. All ground pins must be used.	
150		Ground. All ground pins must be used.	
Halt	9	I	Halt from external debugger, active low.
HoldAck	134	O	Hold Acknowledge. HoldAck outputs a logic 1 when the 403GA relinquishes its external buses to an external bus master. HoldAck outputs a logic 0 when the 403GA regains control of the bus.
HoldReq	14	I	Hold Request. External bus masters can request the 403GA bus by placing a logic1 on this pin. The external bus master relinquishes the bus to the 403GA by deasserting HoldReq.
INT0	31	I	Interrupt 0. INT0 is an interrupt input to the 403GA and users may program the pin to be either edge-triggered or level-triggered and may also program the polarity to be active high or active low. The IOCR contains the bits necessary to program the trigger type and polarity.
INT1	32	I	Interrupt 1. See description of INT0.
INT2	33	I	Interrupt 2. See description of INT0.
INT3	34	I	Interrupt 3. See description of INT0.
INT4	35	I	Interrupt 4. See description of INT0.

IBM PowerPC 403GA

Table 4. 403GA Signal Descriptions

Signal Name	Pin	I/O Type	Function
IVR	39		Interface voltage reference. When connected to 3.3V supply, allows the device to interface to an exclusively 3V system. When connected to 5V supply, allows the device to interface to 5V or mixed 3V/5V system. If any input or output connects to 5V system, this pin must be connected to 5V supply.
$\overline{OE}/XSize1$	126	O/I	Output Enable / External Master Transfer Size 1. When the 403GA is bus master, $\overline{OE}$ enables the selected SRAMs to drive the data bus. The timing parameters of $\overline{OE}$ relative to the chip select, $\overline{CS}$ , are programmable via bits in the 403GA bank registers. When the 403GA is not bus master, $\overline{OE}/XSize1$ is used as one of two external transfer size input bits, $XSize0:1$ .
Ready	13	I	Ready. Ready is used to insert externally generated (device-paced) wait states into bus transactions. The Ready pin is enabled via the Ready Enable bit in 403GA bank registers.
RecvD	27	I	Serial Port Receive Data.
$\overline{Reset}$	91	I/O	$\overline{Reset}$ . A logic 0 input placed on this pin for eight SysClk cycles causes the 403GA to begin a system reset. When a system reset is invoked, the $\overline{Reset}$ pin becomes a logic 0 output for eight SysClk cycles.
$R/\overline{W}$	127	I/O	Read / Write. When the 403GA is bus master, $R/\overline{W}$ is an output which is high when data is read from memory and low when data is written to memory. $R/\overline{W}$ is driven with the same timings as the address bus. When the 403GA is not bus master, $R/\overline{W}$ is an input from the external bus master which indicates the direction of data transfer.
SerClk	26	I	Serial Port Clock. Through the Serial Port Clock Source bit in the Input/Output Configuration register (IOCR), users may choose the serial port clock source from either the input on the SerClk pin or processor SysClk. The maximum allowable input frequency into SerClk is half the SysClk frequency.
SysClk	22	I	SysClk is the processor system clock input. SysClk supports a 50/50 duty cycle clock input at the rated chip frequency.
TCK	6	I	JTAG Test Clock Input. TCK is the clock source for the 403GA test access port (TAP). The maximum clock rate into the TCK pin is one half of the processor SysClk clock rate.
TDI	8	I	Test Data In. The TDI is used to input serial data into the TAP. When the TAP enables the use of the TDI pin, the TDI pin is sampled on the rising edge of TCK and this data is input to the selected TAP shift register.
TDO	16	O	Test Data Output. TDO is used to transmit data from the 403GA TAP. Data from the selected TAP shift register is shifted out on TDO.
TestA	23	I	Reserved for manufacturing test. Tied low for normal operation.

Table 4. 403GA Signal Descriptions

Signal Name	Pin	I/O Type	Function
$\overline{\text{TestB}}$	24	I	Reserved for manufacturing test. Tied high for normal operation.
TestC/Hold-Pri	37	I	TestC. Reserved for manufacturing test during the reset interval. While Reset is active, this signal should be tied low for normal operation. HoldReq Priority. When Reset is not active, this signal is sampled to determine the priority of the external bus master signal HoldReq. If HoldPri = 0 then the HoldReq signal is considered high priority, otherwise HoldReq is considered low priority.
TestD	38	I	Reserved for manufacturing test. Tied low for normal operation.
TimerClk	25	I	Timer Facility Clock. Through the Timer Clock Source bit in the Input/Output Configuration register (IOCR), users may choose the clock source for the Timer facility from either the input on the TimerClk pin or processor CoreClk. The maximum input frequency into TimerClk is half the CoreClk frequency.
TMS	7	I	Test Mode Select. The TMS pin is sampled by the TAP on the rising edge of TCK. The TAP state machine uses the TMS pin to determine the mode in which the TAP operates.
TS0	17	O	Trace Status 0.
TS1	18	O	Trace Status 1.
TS2	19	O	Trace Status 2.
TS3	86	O/I	Trace Status 3.
TS4	85	O/I	Trace Status 4.
TS5	84	O/I	Trace Status 5.
TS6	83	O/I	Trace Status 6.

IBM PowerPC 403GA

Table 4. 403GA Signal Descriptions

Signal Name	Pin	I/O Type	Function
V <sub>DD</sub>	20		Power. All power pins must be connected to 3.3V supply.
	21		Power. All power pins must be connected to 3.3V supply.
	40		Power. All power pins must be connected to 3.3V supply.
	49		Power. All power pins must be connected to 3.3V supply.
	61		Power. All power pins must be connected to 3.3V supply.
	69		Power. All power pins must be connected to 3.3V supply.
	80		Power. All power pins must be connected to 3.3V supply.
	89		Power. All power pins must be connected to 3.3V supply.
	100		Power. All power pins must be connected to 3.3V supply.
	120		Power. All power pins must be connected to 3.3V supply.
	129		Power. All power pins must be connected to 3.3V supply.
	140		Power. All power pins must be connected to 3.3V supply.
	149		Power. All power pins must be connected to 3.3V supply.
160		Power. All power pins must be connected to 3.3V supply.	
XmitD	87	O	Serial port transmit data.

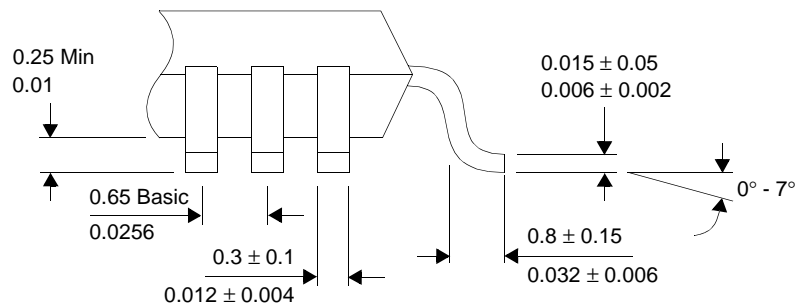
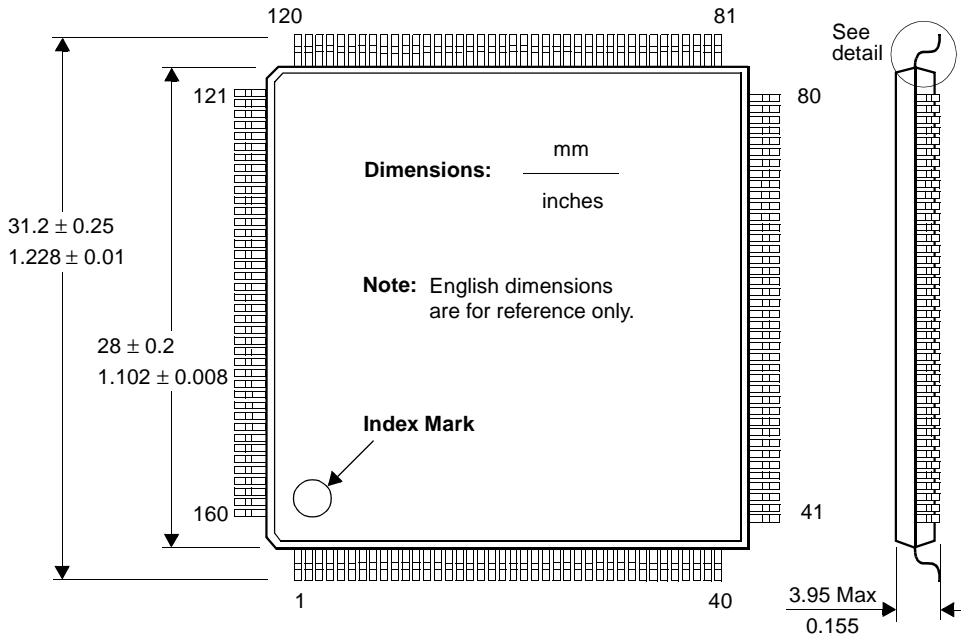

Table 5. Signals Ordered by Pin Number

Pin	Signal Name	Pin	Signal Name	Pin	Signal Name	Pin	Signal Name	Pin	Signal Name
1	GND	33	INT2	65	D18	97	A11	129	V <sub>DD</sub>
2	$\overline{\text{DMAR0}}$	34	INT3	66	D19	98	A12	130	GND
3	$\overline{\text{DMAR1}}$	35	INT4	67	D20	99	A13	131	$\overline{\text{EOT1/TC1}}$
4	$\overline{\text{DMAR2}}$	36	$\overline{\text{CINT}}$	68	D21	100	V <sub>DD</sub>	132	$\overline{\text{EOT2/TC2}}$
5	$\overline{\text{DMAR3/XREQ}}$	37	TestC/HoldPri	69	V <sub>DD</sub>	101	GND	133	$\overline{\text{EOT3/TC3/XSize0}}$
6	TCK	38	TestD	70	GND	102	GND	134	HoldAck
7	TMS	39	IVR	71	D22	103	A14	135	BusReq/ DMADXFER
8	TDI	40	V <sub>DD</sub>	72	D23	104	A15	136	Error
9	Halt	41	GND	73	D24	105	A16	137	$\overline{\text{DRAMOE}}$
10	GND	42	D0	74	D25	106	A17	138	$\overline{\text{DRAMWE}}$
11	BootW	43	D1	75	D26	107	A18	139	AMuxCAS
12	$\overline{\text{BusError}}$	44	D2	76	D27	108	A19	140	V <sub>DD</sub>
13	Ready	45	D3	77	D28	109	A20	141	GND
14	HoldReq	46	D4	78	D29	110	A21	142	$\overline{\text{CAS0}}$
15	GND	47	D5	79	D30	111	GND	143	$\overline{\text{CAS1}}$
16	TDO	48	D6	80	V <sub>DD</sub>	112	A22	144	$\overline{\text{CAS2}}$
17	TS0	49	V <sub>DD</sub>	81	GND	113	A23	145	$\overline{\text{CAS3}}$
18	TS1	50	GND	82	D31	114	A24	146	$\overline{\text{CS7/RAS0}}$
19	TS2	51	D7	83	TS6	115	A25	147	$\overline{\text{CS6/RAS1}}$
20	V <sub>DD</sub>	52	D8	84	TS5	116	A26	148	$\overline{\text{CS5/RAS2}}$
21	V <sub>DD</sub>	53	D9	85	TS4	117	A27	149	V <sub>DD</sub>
22	SysClk	54	D10	86	TS3	118	A28	150	GND
23	TestA	55	D11	87	XmitD	119	A29	151	$\overline{\text{CS4/RAS3}}$
24	$\overline{\text{TestB}}$	56	D12	88	$\overline{\text{DTR/RTS}}$	120	V <sub>DD</sub>	152	$\overline{\text{CS3}}$
25	TimerClk	57	D13	89	V <sub>DD</sub>	121	GND	153	$\overline{\text{CS2}}$
26	SerClk	58	D14	90	GND	122	$\overline{\text{WBE0/A4/BE0}}$	154	$\overline{\text{CS1}}$
27	RecvD	59	GND	91	Reset	123	$\overline{\text{WBE1/A5/BE1}}$	155	$\overline{\text{CS0}}$
28	$\overline{\text{DSR/CTS}}$	60	GND	92	A6	124	$\overline{\text{WBE2/A30/BE2}}$	156	$\overline{\text{DMAA0}}$
29	GND	61	V <sub>DD</sub>	93	A7	125	$\overline{\text{WBE3/A31/BE3}}$	157	$\overline{\text{DMAA1}}$
30	GND	62	D15	94	A8	126	$\overline{\text{OE/XSize1}}$	158	$\overline{\text{DMAA2}}$
31	INT0	63	D16	95	A9	127	R $\overline{\text{W}}$	159	$\overline{\text{DMAA3/XACK}}$
32	INT1	64	D17	96	A10	128	$\overline{\text{EOT0/TC0}}$	160	V <sub>DD</sub>

IBM PowerPC 403GA

PQFP Mechanical Drawing (Top View)



Notes:

1. Packages with date codes later than the 26th week of 1998 (1B26XXXXX) have a package thickness of 3.95 mm (0.155 inches) as shown. Earlier packages have a thickness of 4.5 mm (0.177 inches).
2. Key for reading package date codes of the form "abccddd":  
a = pin 1 indicator  
b = year code (B=1998)  
cc = week code  
ddd = lot number up to 5 digits
3. The date code is usually located beside the index mark on top of the package.

**Package Thermal Specifications**

The 403GA is designed to operate within the case temperature range from -40°C to 120°C. Thermal resistance values are shown in Table 6:

Table 6. Thermal Resistance (°C/Watt)

Parameter	Airflow-ft/min (m/sec)		
	0 (0)	100 (0.51)	200 (1.02)
$\theta_{JC}$ Junction to case	2	2	2
$\theta_{CA}$ Case to ambient PQFP (no heatsink)	37.2	31.6	29.8

**Notes:**

1. Case temperature  $T_{mC}$  is measured at top center of case surface with device soldered to circuit board.
2.  $T_{mA} = T_{mC} - P \times \theta_{CA}$ , where  $T_{mA}$  is ambient temperature.
3.  $T_{mCMax} = T_{mJMax} - P \times \theta_{JC}$ , where  $T_{mJMax}$  is maximum junction temperature and P is power consumption.
4. The above assumes that the chip is mounted on a card with at least one signal and two power planes.

**ELECTRICAL SPECIFICATIONS**

**Absolute Maximum Ratings**

The absolute maximum ratings in Table 7 below are stress ratings only. Operation at or beyond these maximum ratings may cause permanent damage to the device.

Table 7. 403GA Maximum Ratings

Parameter	Maximum Rating
Supply voltage with respect to GND	-0.5V to +3.8V
Voltage on other pins with respect to GND	-0.5V to +5.5V
Case temperature under bias	-40°C to +120°C
Storage temperature	-65°C to +150°C

**Operating Conditions**

The 403GA can interface to either 3V or 5V technologies. The range for supply voltages is

specified for five-percent margins relative to a nominal 3.3V power supply.

Device operation beyond the conditions specified in Table 8 is not recommended. Extended operation beyond the recommended conditions may affect device reliability:

Table 8. Operating Conditions

Symbol	Parameter	Min	Max	Unit
$V_{DD}$	Supply voltage	3.14	3.47	V
$F_C$	SysClock frequency <sup>1</sup> :			MHz
	403GA-25	0	25	
	403GA-33	0	33	
	403GA-40	0	40	
$T_{mC}$	Case temperature under bias	-40	85	°C

**Note:**

1. These frequencies do not account for  $T_{CS}$ . See Table 11.

**Power Considerations**

Power dissipation is determined by operating frequency, temperature, and supply voltage, as well as external source/sink current requirements. Typical power dissipation is 0.2 W at 25 MHz, 0.26 W at 33 MHz, or 0.32 W at 40 MHz,  $T_{mC} = 55$  °C, and  $V_{CC} = 3.3$  V, with an average 10pF capacitive load.

Estimated supply current as a function of frequency is shown in the figure, "Supply Current vs Operating Frequency," on page 28. Derating curves are provided in the section, "Output Derating for Capacitance and Voltage," on page 26.

**Recommended Connections**

Power and ground pins should all be connected to separate power and ground planes in the circuit board to which the 403GA is mounted. Unused input pins must be tied inactive, either high or low.

The interface voltage reference (IVR) pin should be connected to 3.3V supply if all signal pins connecting to the 403GA pins operate at 3V levels. If any signal pin connecting to the 403GA operates with 5V levels, the IVR pin should be connected to 5V supply.

## IBM PowerPC 403GA

### DC Specifications

Table 9. 403GA DC Characteristics

Symbol	Parameter	Min	Max	Units
$V_{IL}$	Input low voltage (except for SysClk)	GND - 0.1	0.8	V
$V_{ILC}$	Input low voltage for SysClk	GND - 0.1	0.8	V
$V_{IH}$	Input high voltage (except for SysClk) <sup>1</sup>	2.0	$V_{IVR} + 0.1$	V
$V_{IHC}$	Input high voltage for SysClk <sup>1</sup>	2.0	$V_{IVR} + 0.1$	V
$V_{OL}$	Output low voltage		0.4	V
$V_{OH}$	Output high voltage	2.4	$V_{DD}$	V
$I_{OH}$	Output high current		2	mA
$I_{OL}$	Output low current		4	mA
$I_{LI}$	Input leakage current		50	$\mu$ A
$I_{LO}$	Output leakage current		10	$\mu$ A
$I_{CC}$	Supply current ( $I_{CC\ Max}$ at $F_C$ of 25 MHz) <sup>2</sup>		200	mA
	Supply current ( $I_{CC\ Max}$ at $F_C$ of 33 MHz) <sup>2</sup>		260	mA
	Supply current ( $I_{CC\ Max}$ at $F_C$ of 40 MHz) <sup>2, 3</sup>		315	mA

#### Notes:

- $V_{IVR}$  is the interface voltage reference to which the IVR pin is tied to select either a 3.3V or 5V interface. For additional information, see "Recommended Connections," on page 19.
- The 403GA drives its outputs to the level of  $V_{DD}$  and, when not driving, the 403GA outputs can be pulled up to 5V by other devices in a system if the 403GA IVR pin has been tied to 5V properly.
- $I_{CC\ Max}$  is measured at  $T_{mC} = 85^\circ\text{C}$ , worst-case recommended operating conditions for frequency and voltage as specified in Table 8 on page 19, and a capacitive load of 50 pF.

Table 10. 403GA I/O Capacitance

Symbol	Parameter	Min	Max	Units
$C_{IN}$	Input capacitance (except for SysClk)		5	pF
$C_{INC}$	Input capacitance for SysClk		25	pF
$C_{OUT}$	Output capacitance <sup>1</sup>		7	pF
$C_{I/O}$	I/O pin capacitance		8	pF

#### Note:

- $C_{Out}$  is specified as the load capacitance of a floating output in high impedance.

### AC Specifications

Clock timing and switching characteristics are specified in accordance with recommended operating conditions in Table 8. AC specifications are tested at  $V_{DD} = 3.14\text{V}$  and  $T_J = 85^\circ\text{C}$  with the 50pF test load shown in the figure at right. Derating of outputs for capacitive loading is shown in the figure "Output Derating for Capacitance and Voltage," on page 26.

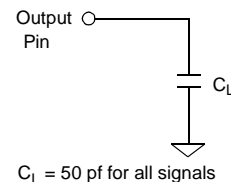

**SysClk Timing Waveform**

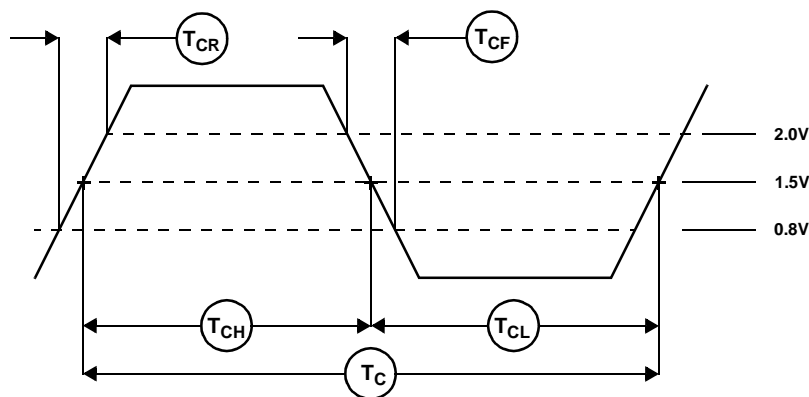

Table 11. 403GA System Clock Timing

Symbol	Parameter	25 MHz		33 MHz		40 MHz		Units
		Min	Max	Min	Max	Min	Max	
$F_C$	SysClk clock input frequency <sup>1</sup>	25		33		40		MHz
$T_C$	SysClk clock period <sup>1</sup>	40		30		25		ns
$T_{CS}$	Clock edge stability <sup>2</sup>	0.2		0.2		0.2		ns
$T_{CH}$	Clock input high time	16		13		11		ns
$T_{CL}$	Clock input low time	16		13		11		ns
$T_{CR}$	Clock input rise time <sup>3</sup>	0.5	2.5	0.5	2.5	0.5	1.5	ns
$T_{CF}$	Clock input fall time <sup>3</sup>	0.5	2.5	0.5	2.5	0.5	1.5	ns

**Notes:**

1. These values do not include the allowable tolerance for clock edge instability represented by  $T_{CS}$ .
2. Cycle-to-cycle jitter allowed between any two edges.
3. Rise and fall times measured between 0.8V and 2.0V.

**Timer Clock and Serial Port Timing Characteristics**

Table 12. 403GA Timer Clock and Serial Clock Timings

Symbol	Parameter	Min	Max	Units
$F_{SC}$	TimerClk, SerClk input frequency	$0.5 F_C$		MHz
$T_{SC}$	TimerClk, SerClk period	$2T_C$		ns
$T_{SCH}$	TimerClk, SerClk input high time	$1/F_C$		ns
$T_{SCL}$	TimerClk, SerClk input low time	$1/F_C$		ns

**Notes:**

1. Maximum input frequency of TimerClk and SerClk must be less than or equal to half of SysClk input frequency.
2. TimerClk and SerClk input high times must be greater than or equal to SysClk period  $T_C$ .
3. TimerClk and SerClk input low times must also be greater than or equal to SysClk period  $T_C$ .

## IBM PowerPC 403GA

Table 13. 403GA Serial Port Output Timings

Symbol	Parameter	25 MHz		33 MHz		40 MHz		Units
		$T_{OHMin}$	$T_{OVMax}$	$T_{OHMin}$	$T_{OVMax}$	$T_{OHMin}$	$T_{OVMax}$	
$T_{OH}, T_{OV}$	Output hold, output valid time							
	$T_{OH1}, T_{OV1}$ $\overline{DTR}/RTS$		14		13		12	ns
	$T_{OH2}, T_{OV2}$ XmitD		12		11		10	

1. Output times are measured with a standard 50 pF capacitive load, unless otherwise noted.

### Input Setup and Hold Waveform

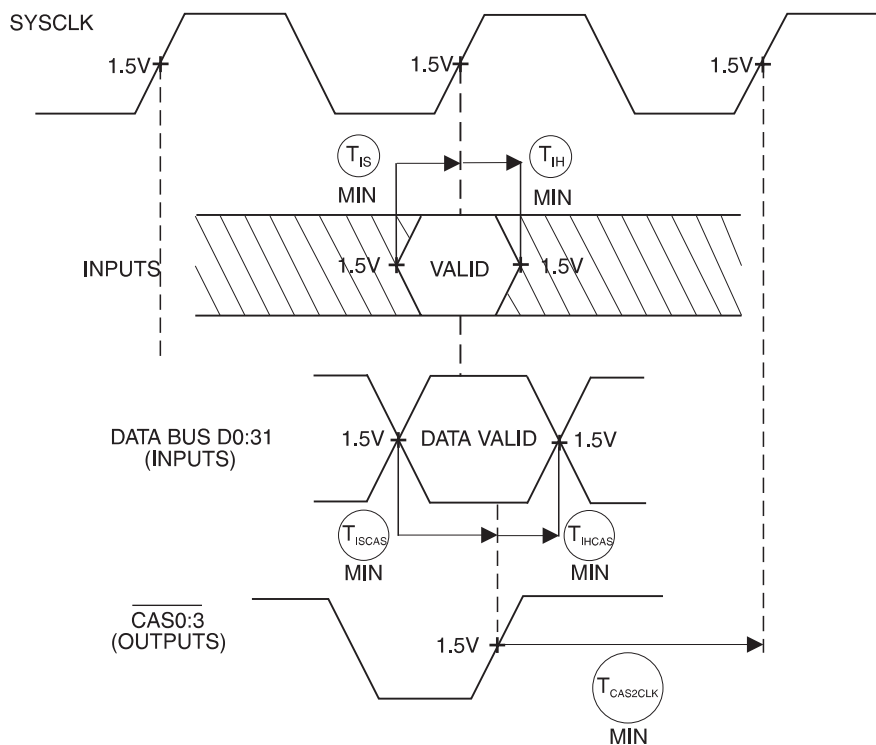

#### Notes:

1. The 403GA may be programmed to latch data from the data bus either on the rise of SysClk or the rise of  $\overline{CAS}$ . When the 403GA is programmed to latch data on  $\overline{CAS}$ , bit 26 of the I/O control register (IOCR) is set to 1.
2.  $T_{CAS2CLK} \geq 15.5$  ns. The capacitive load on the  $\overline{CAS}$  outputs must not delay the  $\overline{CAS}$  low-to-high transition such that the period from the  $\overline{CAS}$  rising edge to the next SysClk rising edge becomes less than 15.5 ns. The maximum value of  $\overline{CAS}$  capacitive loading can be determined by using the output time for  $\overline{CAS}$  from Table 17 on page 29, and applying the appropriate derating factor for your application. See the figure, "Output Derating for Capacitance and Voltage," on page 26.

Table 14. 403GA Synchronous Input Timings

Symbol	Parameter	25 MHz		33 MHz		40 MHz		Units
		Min	Max	Min	Max	Min	Max	
$T_{IS}$	Input setup:							
$T_{IS1}$	A4:11,A22:31	4		3		3		
$T_{IS2}$	BusError	5		5		5		
$T_{IS3}$	D0:31 (to SysClk)	5		4		4		
$T_{ISCAS}$	D0:31 (to $\overline{CAS}$ )	2		2		2		
$T_{IS4}$	HoldPri	3		3		3		ns
$T_{IS5}$	HoldReq	4		3		3		
$T_{IS6}$	R/W	3		3		3		
$T_{IS7}$	Ready	6		5		5		
$T_{IS8}$	$\overline{XReq}$	5		4		4		
$T_{IS9}$	XSize0:1	5		4		4		
$T_{IH}$	Input hold:							
$T_{IH1}$	A4:11,A22:31	2		2		2		
$T_{IH2}$	BusError	2		2		2		
$T_{IH3}$	D0:31 (after SysClk)	2		2		2		
$T_{IHCAS}$	D0:31 (after $\overline{CAS}$ )	3		3		3		
$T_{IH4}$	HoldPri	2		2		2		ns
$T_{IH5}$	HoldReq	2		2		2		
$T_{IH6}$	R/W	2		2		2		
$T_{IH7}$	Ready	2		2		2		
$T_{IH8}$	$\overline{XReq}$	2		2		2		
$T_{IH9}$	XSize0:1	2		2		2		
$T_R, T_F$	Rise/fall time	0.5	2.5	0.5	2.5	0.5	2.5	ns

Table 15. 403GA Asynchronous Input Timings

Symbol	Parameter	25 MHz		33 MHz		40 MHz		Units
		Min	Max	Min	Max	Min	Max	
T <sub>IS</sub>	Input setup time							
	T <sub>IS10</sub>	$\overline{\text{CINT}}$	5		3		3	
	T <sub>IS11</sub>	DMAR0:3	3		3		3	
	T <sub>IS12</sub>	EOT0:3	3		3		3	ns
	T <sub>IS13</sub>	HALT	3		3		3	
	T <sub>IS14</sub>	INT0:4	6		5		5	
	T <sub>IS15</sub>	Reset	8		8		8	
T <sub>IH</sub>	Input hold time							
	T <sub>IH10</sub>	$\overline{\text{CINT}}$	T <sub>C</sub>		T <sub>C</sub>		T <sub>C</sub>	
	T <sub>IH11</sub>	DMAR0:3	T <sub>C</sub>		T <sub>C</sub>		T <sub>C</sub>	
	T <sub>IH12</sub>	EOT0:3	T <sub>C</sub>		T <sub>C</sub>		T <sub>C</sub>	ns
	T <sub>IH13</sub>	HALT	T <sub>C</sub>		T <sub>C</sub>		T <sub>C</sub>	
	T <sub>IH14</sub>	INT0:4	T <sub>C</sub>		T <sub>C</sub>		T <sub>C</sub>	
	T <sub>IH15</sub>	Reset	Note 1, 2		Note 1, 2		Note 1, 2	

**Notes:**

1. During a system-initiated reset,  $\overline{\text{Reset}}$  must be taken low for a minimum of eightSysClk cycles.
2. The BootW input has a maximum rise time requirement of 10 ns when it is tied to  $\overline{\text{Reset}}$ .
3. Input hold times are measured at 3.47V and T<sub>J</sub> = 0°C.

**Output Delay and Float Timing Waveform**

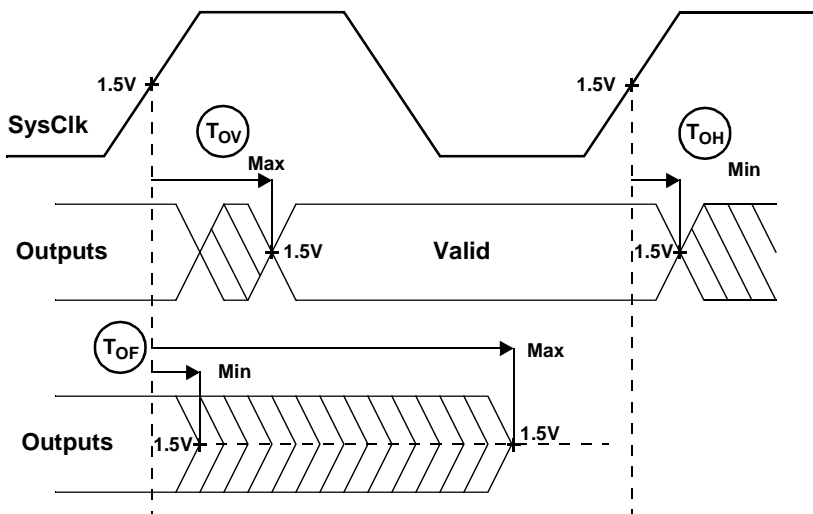



Table 16. 403GA Synchronous Output Timings

Symbol	Parameter	25 MHz		33 MHz		40 MHz		Units
		T <sub>OHMin</sub>	T <sub>OVMax</sub>	T <sub>OHMin</sub>	T <sub>OVMax</sub>	T <sub>OHMin</sub>	T <sub>OVMax</sub>	
T <sub>OH</sub> , T <sub>OV</sub>	Output hold, output valid time							
	T <sub>OH1</sub> , T <sub>OV1</sub> A6:31	4	15	4	13	4	11	
	T <sub>OH2</sub> , T <sub>OV2</sub> AMuxCAS	3	11	3	11	3	10	
	T <sub>OH3</sub> , T <sub>OV3</sub> BusReq	3	12	3	11	3	10	
	T <sub>OH4</sub> , T <sub>OV4</sub> CAS0:3	4	13	4	12	4	11	
	T <sub>OH5</sub> , T <sub>OV5</sub> CS0:7	2	13	2	11	2	10	
	T <sub>OH6</sub> , T <sub>OV6</sub> D0:31	4	16	4	15	4	14	
	T <sub>OH7</sub> , T <sub>OV7</sub> DMAA0:3	3	11	3	10	3	9	
	T <sub>OH8</sub> , T <sub>OV8</sub> DMADXFER	3	13	3	11	3	10	
	T <sub>OH9</sub> , T <sub>OV9</sub> DRAMOE	3	11	3	11	3	10	
	T <sub>OH10</sub> , T <sub>OV10</sub> DRAMWE	2	10	3	10	3	9	ns
	T <sub>OH11</sub> , T <sub>OV11</sub> Error	4	14	4	12	4	12	
	T <sub>OH12</sub> , T <sub>OV12</sub> HoldAck	3	12	3	11	3	10	
	T <sub>OH13</sub> , T <sub>OV13</sub> OE	3	11	3	10	3	9	
	T <sub>OH14</sub> , T <sub>OV14</sub> RAS0:3	3	12	3	11	3	10	
	T <sub>OH15</sub> , T <sub>OV15</sub> RAS0:3 (Early)	12	22	11	20	11	18	
	T <sub>OH16</sub> , T <sub>OV16</sub> Reset	3	14	3	12	3	12	
	T <sub>OH17</sub> , T <sub>OV17</sub> R/W	3	11	3	10	3	9	
	T <sub>OH18</sub> , T <sub>OV18</sub> TC0:3	3	13	3	12	3	11	
	T <sub>OH19</sub> , T <sub>OV19</sub> TS0:6	4	30	4	25	4	22	
	T <sub>OH20</sub> , T <sub>OV20</sub> WBEO:3(BE0:3)	3	12	3	11	3	10	
	T <sub>OH21</sub> , T <sub>OV21</sub> XAck	3	13	3	12	3	11	
T <sub>OF</sub>	Output float time	<b>Min</b>	<b>Max</b>	<b>Min</b>	<b>Max</b>	<b>Min</b>	<b>Max</b>	
	T <sub>OF1</sub> A6:31	2	10	2	9	2	9	
	T <sub>OF2</sub> CS0:7	3	12	3	10	3	10	
	T <sub>OF3</sub> D0:31	3	11	3	9	3	9	ns
	T <sub>OF4</sub> OE	3	12	3	10	3	10	
	T <sub>OF5</sub> Reset	2	8	2	7	2	7	
	T <sub>OF6</sub> R/W	3	12	3	10	3	10	
	T <sub>OF7</sub> TC0:3	3	12	3	10	3	10	
	T <sub>OF8</sub> WBEO:3(BE0:3)	3	12	3	10	3	10	
T <sub>CAS</sub>	Available CAS access time	<b>Min</b>	<b>Max</b>	<b>Min</b>	<b>Max</b>	<b>Min</b>	<b>Max</b>	
	2-1-1-1 access mode (Note )	0.5T <sub>C</sub> -2.5		0.5T <sub>C</sub> - 2.5		0.5T <sub>C</sub> - 2.5		ns
	3-2-2-2 access mode (Note )	1.5T <sub>C</sub> -2.5		1.5T <sub>C</sub> -2.5		1.5T <sub>C</sub> -2.5		

**Notes:**

- For normal RAS and CAS timing, T<sub>OH</sub> is relative to the rising edge of SysClk and T<sub>OV</sub> is relative to the falling edge of SysClk. In early RAS mode, T<sub>OV</sub> is relative to the rising edge of SysClk. CAS access time assumes a SysClk 50% duty cycle.
- In early RAS mode, the RAS output delay varies with the 403GA operating frequency. Use the following equation to determine the worst-case output delay for this signal: T<sub>OVMax</sub> = 12 ns + T<sub>c</sub>/4; T<sub>OHMin</sub> remains unchanged. Valid for T<sub>c</sub> greater than 30 ns and less than 80 ns.
- When initiating a system reset, the 403GA pulls the Reset output low for 2048 cycles minimum and then samples to determine when Reset has gone low. Three cycles after Reset has been sampled as low, the 403GA stops driving the Reset output. At this time the system must hold Reset low for five more cycles. Output times are measured with a standard 50 pF capacitive load, unless otherwise noted. Output hold times are measured at 3.47V and T<sub>J</sub> = 0°C.
- Output times are measured with a standard 50 pF capacitive load, unless otherwise noted. Output hold times are measured at 3.47V and T<sub>J</sub> = 0°C.

IBM PowerPC 403GA

Output Derating for Capacitance and Voltage

Output Propagation Delay Derating

Derating Equations for Output Delays:

1.  $\Delta t_{p_{LH}}(C_L, V) = t_{p_{LH}\Delta C} + t_{p_{LH}\Delta V}$
2.  $\Delta t_{p_{HL}}(C_L, V) = t_{p_{HL}\Delta C} + t_{p_{HL}\Delta V}$
3.  $\Delta t_{p_{ZL5V}}(C_L, V) = t_{p_{ZL}\Delta C} + t_{p_{HL}\Delta V}$

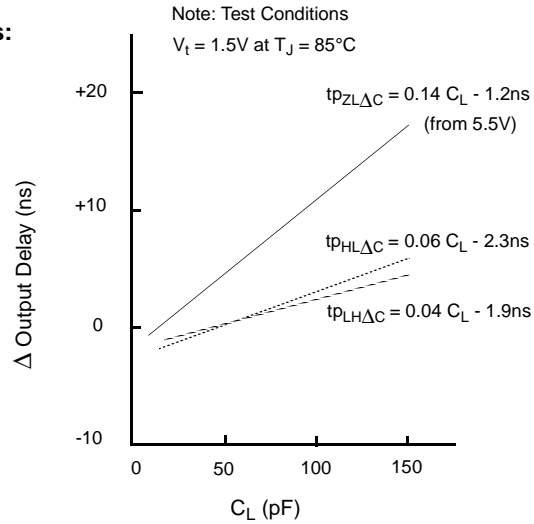

Output Propagation Delay Derating vs Output Voltage Level

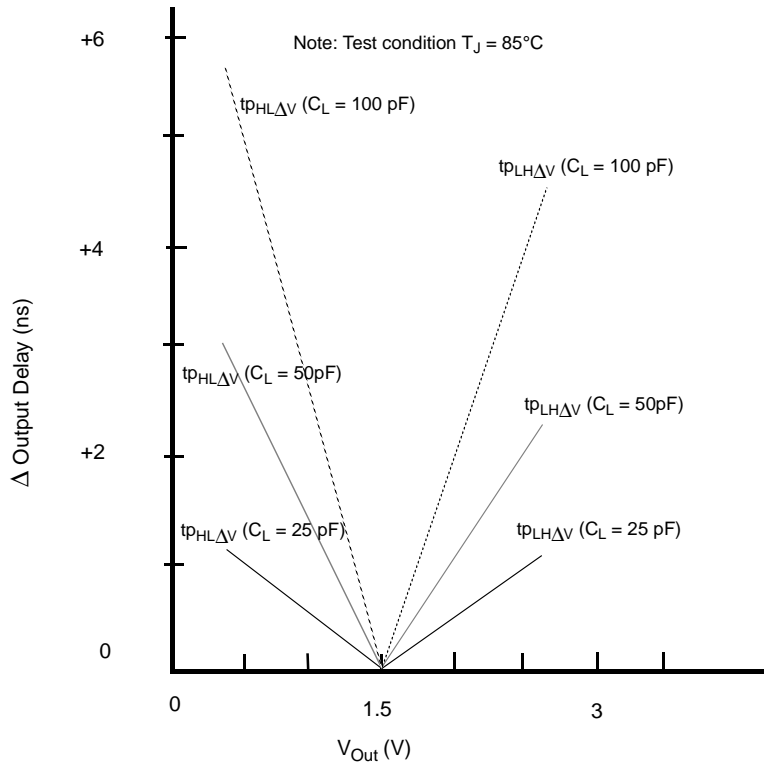

**Output Rise and Fall Time Derating**

**Derating Equations for Output Rise and Fall Times:**

- 4.  $t_R(C_L) = 2ns + tp_{t\Delta C}$
- 5.  $t_F(C_L) = 2.5ns + tp_{t\Delta C}$

**Output Transition Time Derating**

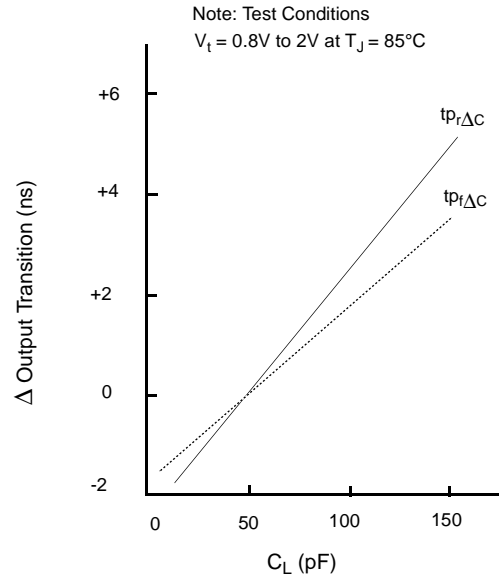

**Output Voltage vs Output Current**

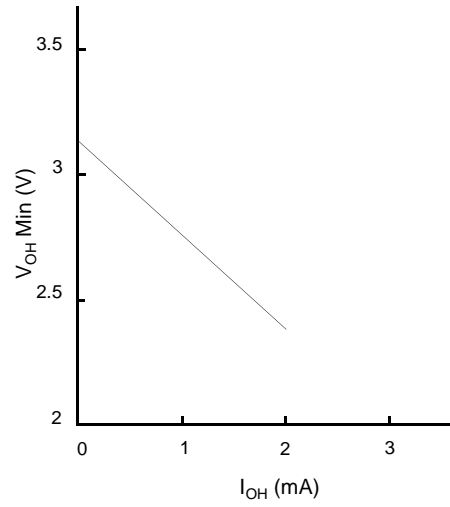
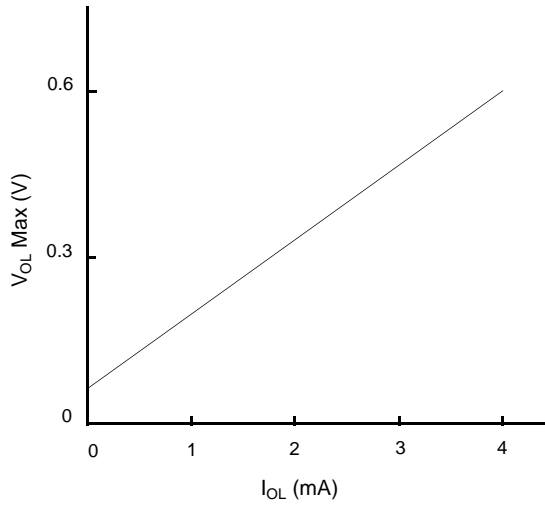

Note: Test conditions 3.14V at  $T_J = 85^\circ C$

# IBM PowerPC 403GA

## Receiver Input Voltage vs DC Input Current

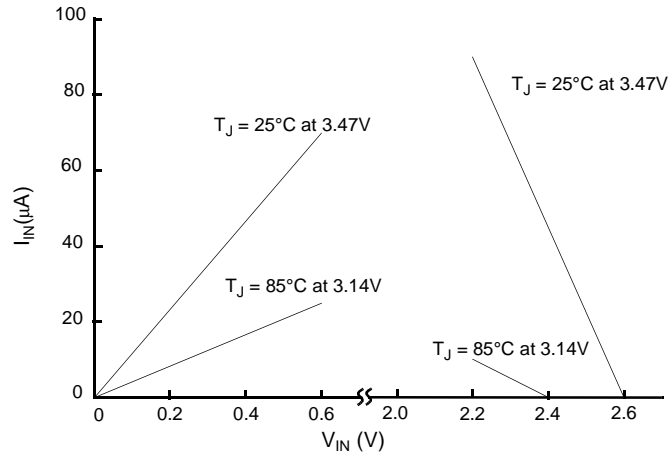

**Note:**

- Applies to receivers for asynchronous inputs on pins 2-9, 11,13, 23, 25-28, 31-38, and 91, and synchronous inputs on pins 5, 12, and 14.

## Receiver Noise Sensitivity

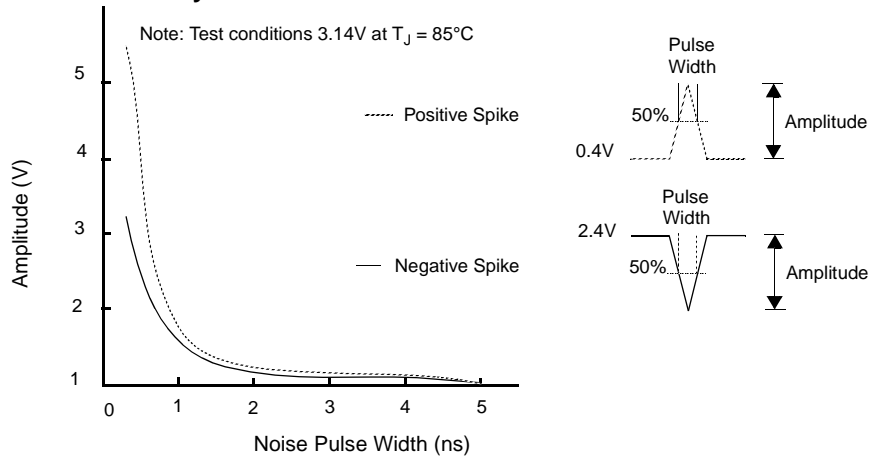

## Supply Current vs Operating Frequency

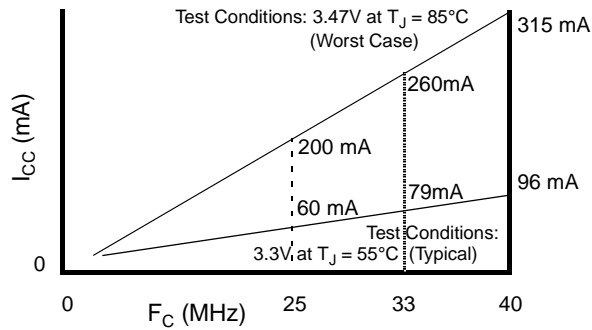

## IBM PowerPC 403GA

### Reset and HoldAck

The following table summarizes the states of signals on output pins when  $\overline{\text{Reset}}$  or HoldAck is active.

Table 17. Signal States During Reset or Hold Acknowledge

Signal Names	State When $\overline{\text{Reset}}$ Active	State When HoldAck Active
A6:29	Floating	Floating (set to input mode)
AMuxCAS	Inactive (low)	Operable (see note 1)
BusReq	Inactive (low)	Operable (see note 1)
$\overline{\text{CAS0:3}}$	Inactive (high)	Operable (see notes 1 and 2)
$\overline{\text{CS0:3}}$	Floating	Floating
$\overline{\text{CS4:7/RAS3:0}}$	Floating	$\overline{\text{CS}}$ floating, $\overline{\text{RAS}}$ operable (notes 1 and 2)
D0:31	Floating	Floating (external master drives bus)
$\overline{\text{DMAA0:3}}$	Inactive (high)	Inactive (high)
$\overline{\text{XAck}}$	Inactive (high)	Operable (see note 1)
$\overline{\text{DRAMOE}}$	Inactive (high)	Operable (see notes 1 and 2)
$\overline{\text{DRAMWE}}$	Inactive (high)	Operable (see notes 1 and 2)
Error	Inactive (low)	Operable (see note 1)
HoldAck	Inactive (low)	Active
$\overline{\text{OE}}$	Floating	Floating (input for XSize1)
$\overline{\text{Reset}}$	Floating unless initiating system reset	Floating unless initiating system reset
$\overline{\text{R/W}}$	Floating	Floating (set to input)
$\overline{\text{TC0:2}}$	Floating (set to input)	Inactive (high)
$\overline{\text{TC3}}$	Floating (set to input)	Floating (input for XSize0)
TDO	Floating	Operable (see note 1)
TS0:	Inactive (low)	Operable (see note 1)
$\overline{\text{WBE0:3}}$	Floating	Operable (inputs for A4:5, A30:31)
XmitD	Inactive (high)	Operable (see note 1)

**Note:**

- Signal may be active while HoldAck is asserted, depending on the operation being performed by the 403GA.

### BUS WAVEFORMS

The waveforms in this section represent external bus operations, including SRAM and DRAM accesses, DMA transfers, and external master operations.

#### Write Byte Enable Encoding

The 403GA provides four write byte enable signals ( $\overline{\text{WBE0:3}}$ ) to support 8-, 16-, and 32-bit devices, as shown in Table 18. For an eight-bit memory region,  $\overline{\text{WBE2:3}}$  are encoded as A30:31 and  $\overline{\text{WBE0}}$  is the byte-enable line. For a 16-bit region,  $\overline{\text{WBE0}}$  is the high-byte enable,  $\overline{\text{WBE1}}$  is the low-byte enable and  $\overline{\text{WBE2:3}}$  are encoded as A30:31. For a 32-bit region, address bits A6:29 select the word address and  $\overline{\text{WBE0:3}}$  select data bytes 0:3, respectively.

Table 18. Write Byte Enable Encoding

	Transfer Size	Address	$\overline{WBE0} = \overline{WE}$	$\overline{WBE1} = 1$	$\overline{WBE2} = A30$	$\overline{WBE3} = A31$
<b>8-Bit Bus Width</b>	Byte	0	0	1	0	0
	Byte	1	0	1	0	1
	Byte	2	0	1	1	0
	Byte	3	0	1	1	1
	Transfer Size	Address	$\overline{WBE0} = \overline{BHE}$	$\overline{WBE1} = \overline{BLE}$	$\overline{WBE2} = A30$	$\overline{WBE3} = A31$
<b>16-Bit Bus Width</b>	Half-word	0	0	0	0	0
	Half-word	2	0	0	1	0
	Byte	0	0	1	0	0
	Byte	1	1	0	0	1
	Byte	2	0	1	1	0
	Byte	3	1	0	1	1
	Transfer Size	Address	$\overline{WBE0}$	$\overline{WBE1}$	$\overline{WBE2}$	$\overline{WBE3}$
<b>32-Bit Bus Width</b>	Word	0	0	0	0	0
	Half-word	0	0	0	1	1
	Half-word	2	1	1	0	0
	Byte	0	0	1	1	1
	Byte	1	1	0	1	1
	Byte	2	1	1	0	1
	Byte	3	1	1	1	0

**Address Bus Multiplexing**

To support memories and I/O devices with differing configurations and bus widths, the 403GA provides an internally multiplexed address bus controlled by the BIU. Table 19 shows the multiplexed address outputs referenced by waveforms later in this section.

Table 19. Multiplexed Address Outputs

<b>Address Pins</b>	A11	A12	A13	A14	A15	A16	A17	A18	A19	A20	A21	A22	A23	A24	A25	A26	A27	A28	A29	A30	A31
Addr Bits Out in $\overline{RAS}$ Cycle	a6	a7	a8	a9	a10	a11	a12	a13	a12	a13	a14	a15	a16	a17	a18	a19	a20	a21	a22		
Addr Bits Out in $\overline{CAS}$ Cycle	xx	a6	a7	a8	a9	a10	a11	a12	a21	a22	a23	a24	a25	a26	a27	a28	a29	a30	a31		

## IBM PowerPC 403GA

### SRAM Read-Write-Read with Zero Wait and One Hold

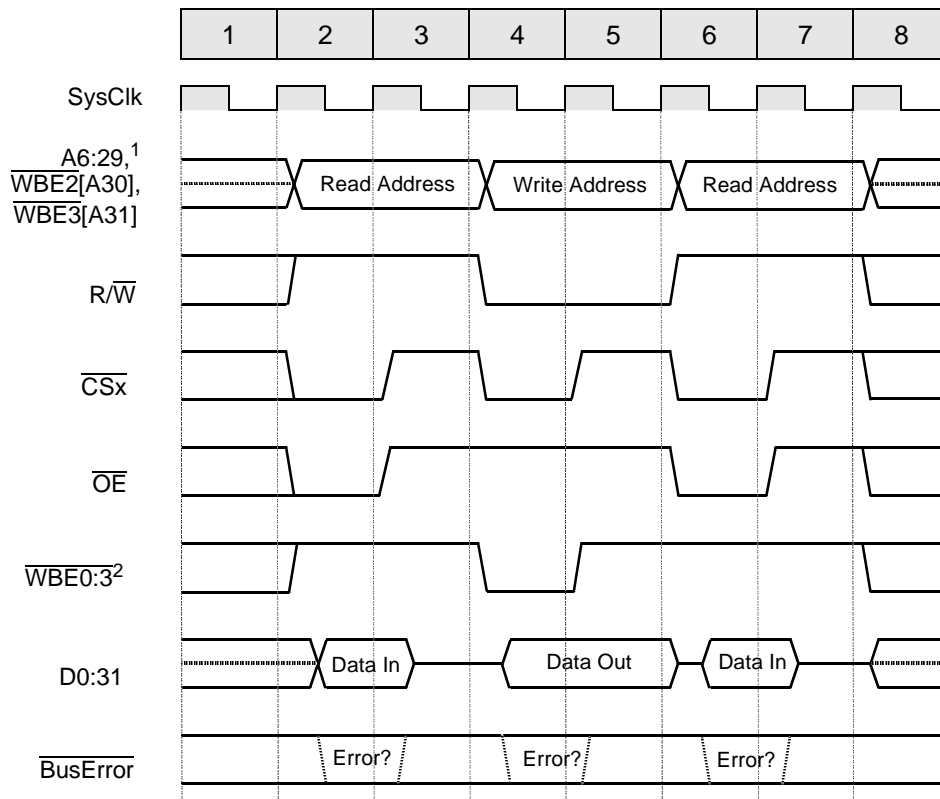

#### Bank Register Bit Settings

SLF	Burst Mode	Bus Width	Ready Enable	Wait States	C <sub>Son</sub>	O <sub>Eon</sub>	W <sub>Eon</sub>	W <sub>Eoff</sub>	Hold
Bit 13	Bit 14	Bits 15:16	Bit 17	Bits 18:23	Bit 24	Bit 25	Bit 26	Bit 27	Bits 28:30
0 or 1	0	xx	0	00 0000	0	0	0	0	001

#### Notes:

1. WBE2:3 are address bits 30:31 if the bus width is programmed as byte or halfword.
2. See Table 18 on page 30 for WBE signal definitions based on bus width.

SRAM, ROM, or I/O Write Request with Wait and Hold

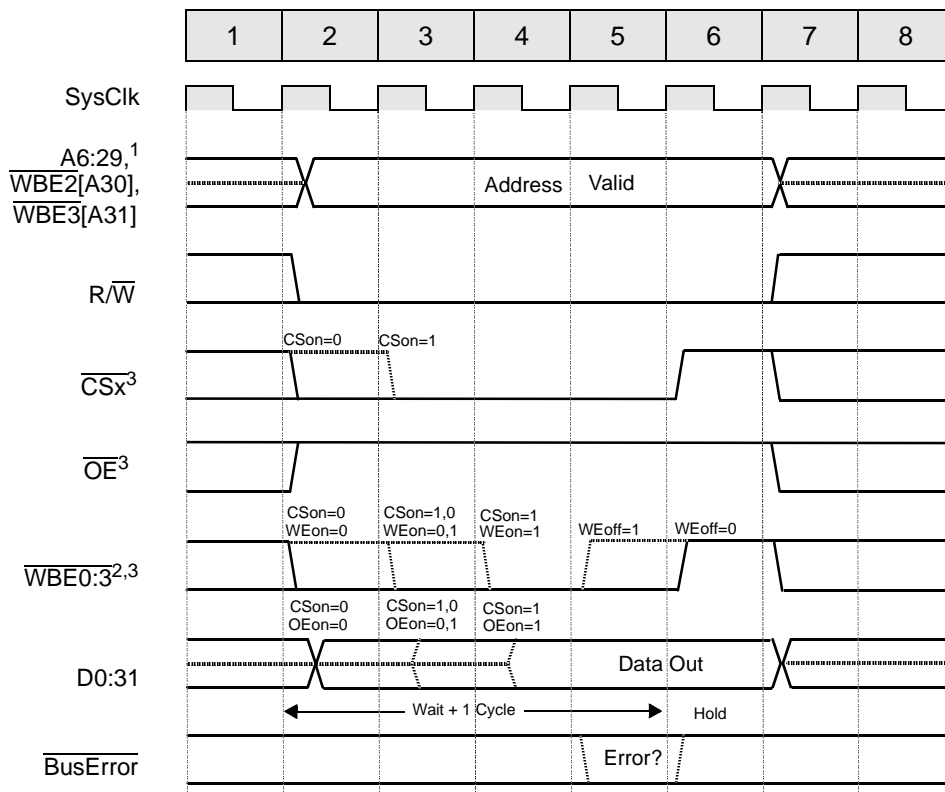

Bank Register Bit Settings

SLF	Burst Mode	Bus Width	Ready Enable	Wait States	CSON	OEon	WEon	WEoff	Hold
Bit 13	Bit 14	Bits 15:16	Bit 17	Bits 18:23	Bit 24	Bit 25	Bit 26	Bit 27	Bits 28:30
0 or 1	0	xx	0	00 0011	0 or 1	0 or 1	0 or 1	0 or 1	001

Notes:

- WBE2:3 are address bits 30:31 if the bus width is programmed as byte or halfword.
- See Table 18 for WBE signal definitions based on bus width.
- 403GAWait must be programmed to a value  $\geq (CSON + WEon + WEoff)$  and  $\geq (CSON + OEon + WEoff)$ .  
If Wait  $> (CSON + WEon)$  and  $> (CSON + OEon)$ , then all signals retain the values shown in cycle 4 until the Wait time expires.
- If Hold is programmed  $> 001$ , all signals retain the values shown in cycle 6 until the Hold timer expires.



## IBM PowerPC 403GA

### SRAM, ROM, or I/O Read Request, Wait Extended with Ready

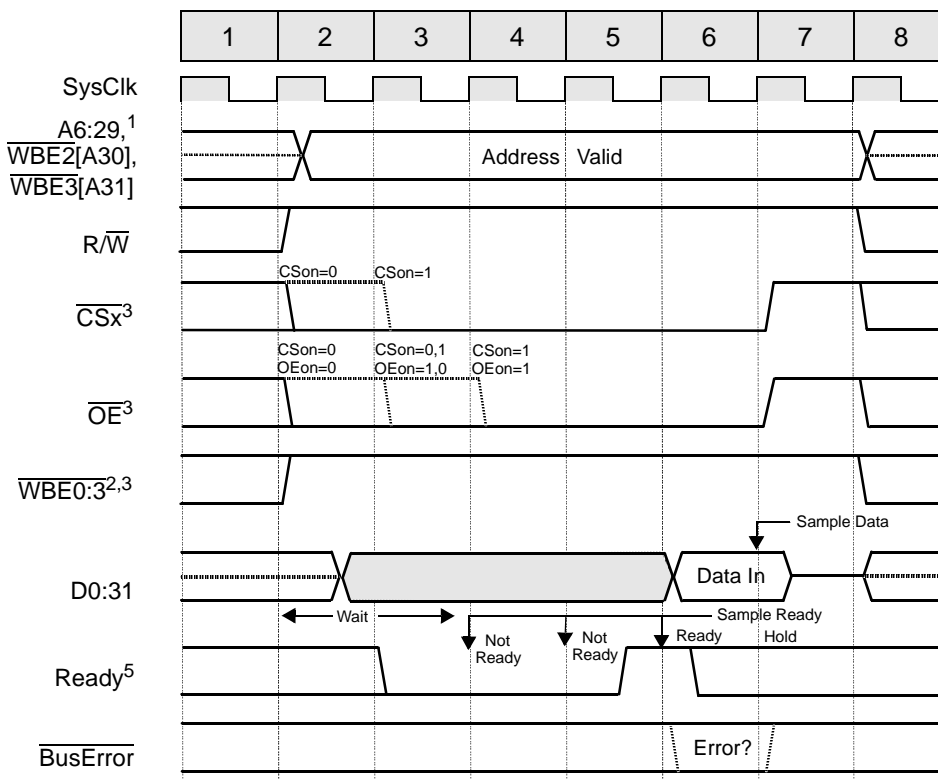

#### Bank Register Bit Settings

SLF	Burst Mode	Bus Width	Ready Enable	Wait States	CSon	OEon	WEon	WEoff	Hold
Bit 13	Bit 14	Bits 15:16	Bit 17	Bits 18:23	Bit 24	Bit 25	Bit 26	Bit 27	Bits 28:30
0 or 1	0	xx	1	00 0010	0 or 1	0 or 1	0 or 1	x	001

#### Notes:

1. WBE2:3 are address bits 30:31 if the bus width is programmed as byte or halfword.
2. See Table 18 on page 30 for WBE signal definitions based on bus width.
3. Wait must be programmed to a value  $\geq$  (CSon + OEon). If Wait > (CSon + OEon), then all signals will retain the values shown in cycle 4 until the Wait timer expires.
4. If Hold is programmed > 001, all 403GA output signals retain the values shown in cycle 7 until the Hold timer expires.
5. If Wait = 00 0000, the Ready input is ignored and single-cycle transfers occur. If Wait = 00 0001, Ready is sampled starting in cycle 2. If Wait > 00 0001, Ready is sampled starting after the Wait cycles have expired.

SRAM, ROM or I/O Burst Read with Wait and Hold

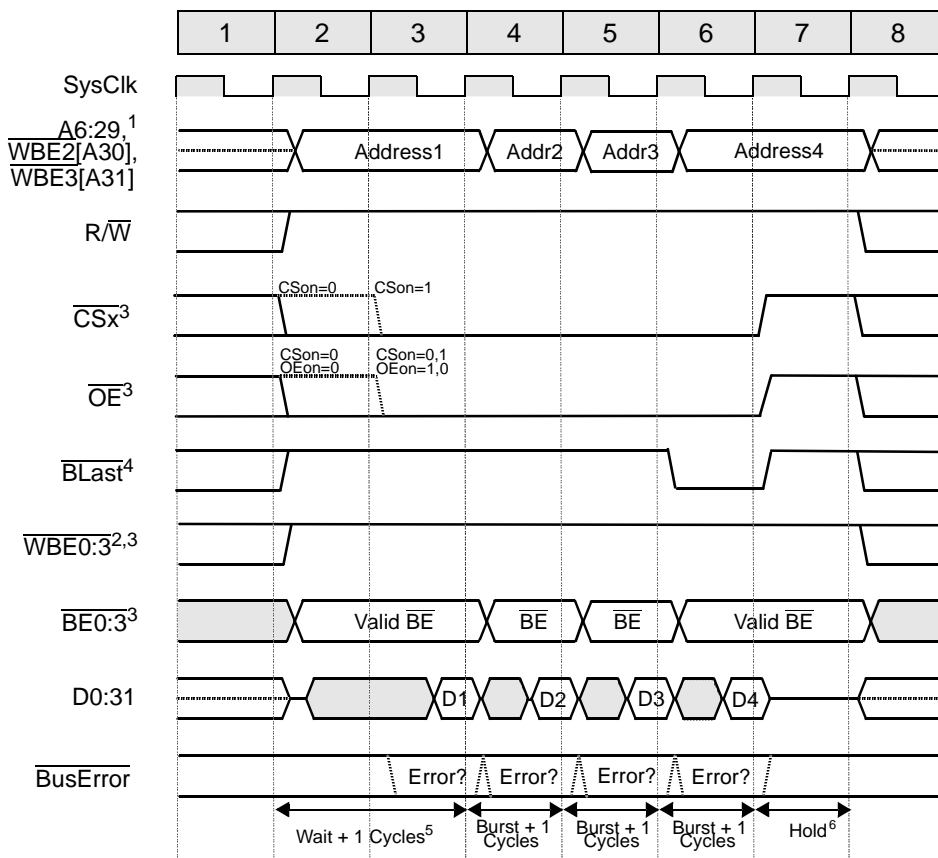

Bank Register Bit Settings

SLF	Burst Mode	Bus Width	Ready Enable	Wait States	Burst Wait	CSON	OEON	WEON	WEOFF	Hold
Bit 13	Bit 14	Bits 15:16	Bit 17	Bits 18:21	Bits 22:23	Bit 24	Bit 25	Bit 26	Bit 27	Bits 28:30
0 or 1	1	xx	0	0001	00	0 or 1	0 or 1	x	x	001

Notes:

1. WBE2:3 are address bits 30:31 if the bus width is programmed as byte or halfword.
2. See Table 18 on page 30 for WBE signal definitions based on bus width.
3. Wait must be programmed to a value  $\geq$  (CSON + OEON). If Wait > (CSON + OEON), then all signals will retain the values shown in cycle 3 until the Wait timer expires.
4. If Hold is programmed > 001, all 403GA output signals retain the values shown in cycle 7 until the Hold timer expires.

## IBM PowerPC 403GA

### SRAM, ROM or I/O Burst Write with Wait, Burst Wait, and Hold

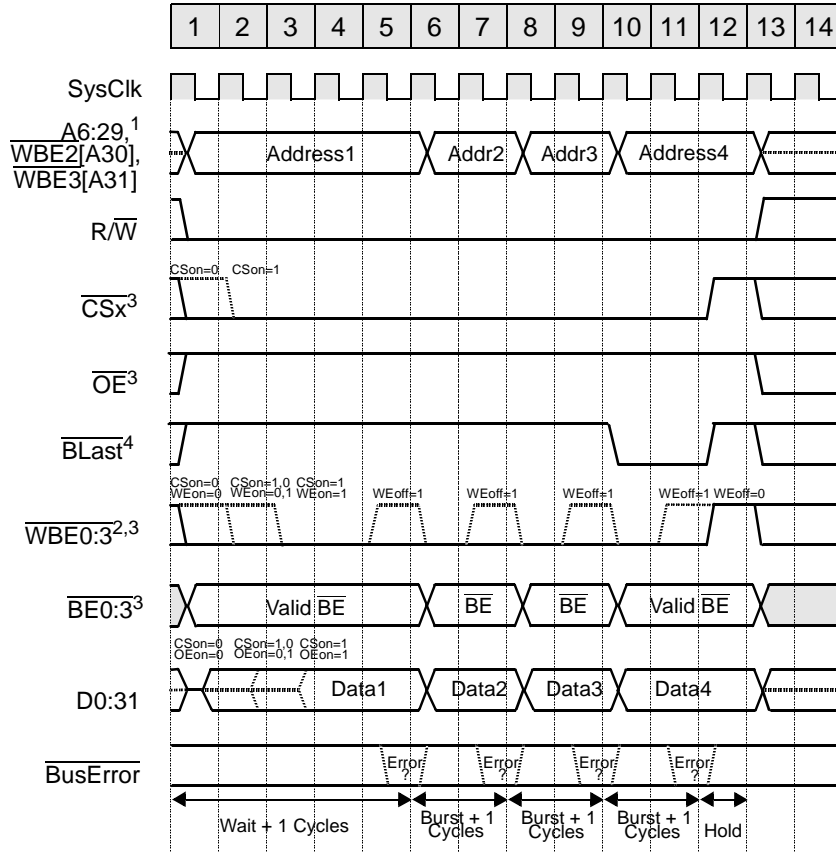

### Bank Register Bit Settings

SLF	Burst Mode	Bus Width	Ready Enable	Wait States	Burst Wait	CSon	OEon	WEon	WEoff	Hold
Bit 13	Bit 14	Bits 15:16	Bit 17	Bits 18:21	Bits 22:23	Bit 24	Bit 25	Bit 26	Bit 27	Bits 28:30
0 or 1	1	xx	0	0100	01	0 or 1	0 or 1	0 or 1	0 or 1	001

#### Notes:

- WBE2:3 are address bits 30:31 if the bus width is programmed as byte or halfword.
- See Table 18 on page 30 for WBE signal definitions based on bus width.
- Wait must be programmed to a value  $\geq$  (CSon + WEon + WEoff) and  $\geq$  (CSon + OEon + WEoff). If Wait > (CSon + WEon) and > (CSon + OEon), then all signals retain the values shown in cycle 3 until the Wait timer expires.
- If Hold is programmed > 001, all 403GA output signals retain the values shown in cycle 12 until the Hold timer expires.

**DRAM 2-1-1-1 Page Mode Read**

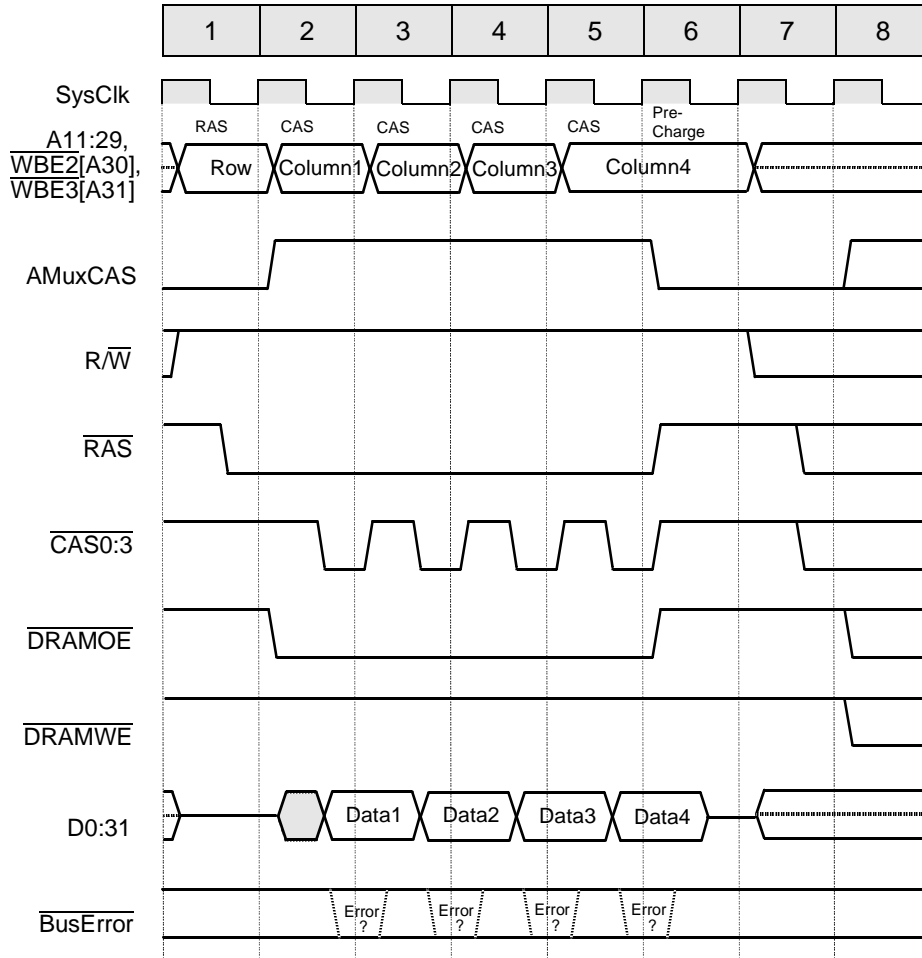

**Bank Register Bit Settings**

SLF	ERM	Bus Width	Ext Mux	RAS-to-CAS	Refresh Mode	Page Mode	First Access	Burst Access	Prechg Cycles	Refresh RAS	Refresh Rate
Bit 13	Bit 14	Bits 15:16	Bit 17	Bit 18	Bit 19	Bit 20	Bits 21:22	Bits 23:24	Bit 25	Bit 26	Bits 27:30
0 or 1	0	xx	x	0	0	1	00	00	0	x	xxxx

**Notes:**

1. For burst access, the addresses represented by Columns 1 to 4 does not necessarily indicate that they are in incremental address order. Typically, burst access is target word first.
2. If internal mux mode is used, address bits A11:29 represent address bits described in Table 19 on page 30.
3. During internal mux mode access, A6:10 retain their unmuxed values.
4. If external mux mode is used, A11:29 are unaffected and do not change between  $\overline{\text{CAS}}$  and  $\overline{\text{RAS}}$  cycles.
5. If bus width is programmed as byte or half-word,  $\overline{\text{WBE2:3}}$  represent address bits A30:31 regardless of mux mode.
6.  $\overline{\text{WBE0:1}}$  are always ones during DRAM transfers.

## IBM PowerPC 403GA

### DRAM 3-2-2-2 Page Mode Write

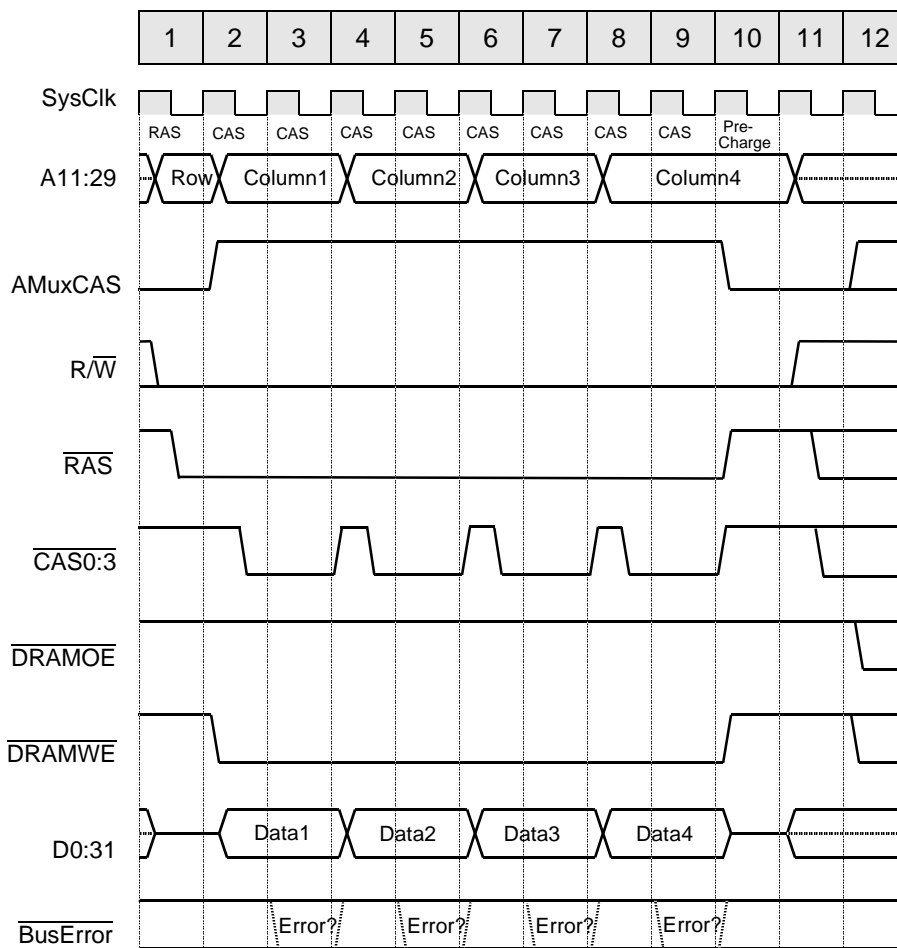

### Bank Register Bit Settings

SLF	ERM	Bus Width	Ext Mux	RAS-to-CAS	Refresh Mode	Page Mode	First Access	Burst Access	Prechg Cycles	Refresh RAS	Refresh Rate
Bit 13	Bit 14	Bits 15:16	Bit 17	Bit 18	Bit 19	Bit 20	Bits 21:22	Bits 23:24	Bit 25	Bit 26	Bits 27:30
0 or 1	0	xx	x	0	0	1	01	01	0	x	xxxx

#### Notes:

1. For burst access, the addresses represented by Columns 1 to 4 do not necessarily indicate that they are in incremental address order. Typically, burst access is target word first.
2. If internal mux mode is used, address bits A11:29 represent address bits described in Table 19 on page 30.
3. During internal mux mode access, A6:10 retain their unmuxed values.
4. If external mux mode is used, A11:29 are unaffected and do not change between  $\overline{\text{CAS}}$  and  $\overline{\text{RAS}}$  cycles.
5. If bus width is programmed as byte or half-word,  $\overline{\text{WBE2:3}}$  represent address bits A30:31 regardless of mux mode.
6.  $\overline{\text{WBE0:1}}$  are always ones during DRAM transfers.

**DRAM Read-Write-Read, One Wait**

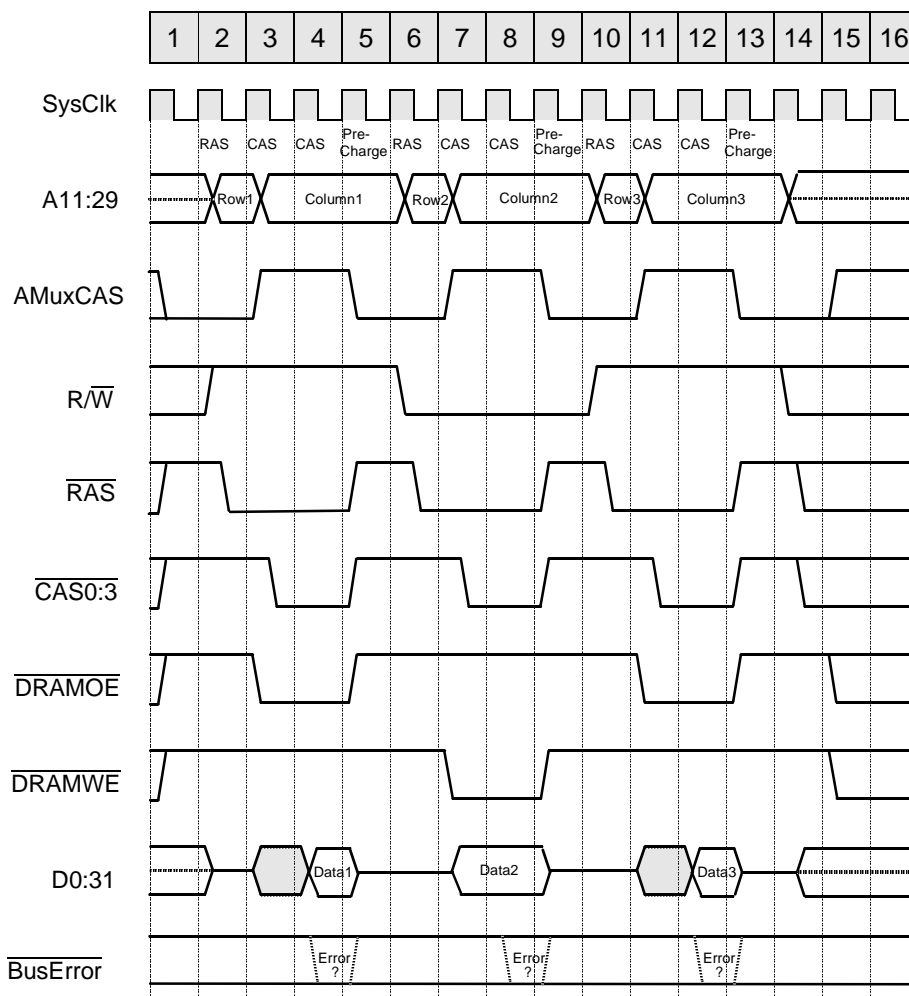

**Bank Register Bit Settings**

SLF	ERM	Bus Width	Ext Mux	RAS-to-CAS	Refresh Mode	Page Mode	First Access	Burst Access	Prechg Cycles	Refresh RAS	Refresh Rate
Bit 13	Bit 14	Bits 15:16	Bit 17	Bit 18	Bit 19	Bit 20	Bits 21:22	Bits 23:24	Bit 25	Bit 26	Bits 27:30
0 or 1	0	xx	x	0	0	0	01	xx	0	x	xxxx

**Notes:**

1. If internal mux mode is used, address bits A11:29 represent address bits described in Table 19 on page 30.
2. During internal mux mode access, A6:10 retain their unmuxed values.
3. If external mux mode is used, A11:29 are unaffected and do not change between  $\overline{\text{CAS}}$  and  $\overline{\text{RAS}}$  cycles.
4. If bus width is programmed as byte or half-word,  $\overline{\text{WBE2:3}}$  represent address bits A30:31 regardless of mux mode.
5.  $\overline{\text{WBE0:1}}$  are always ones during DRAM transfers.

## IBM PowerPC 403GA

### DMA Buffered Single Transfer from Peripheral to 3-Cycle DRAM

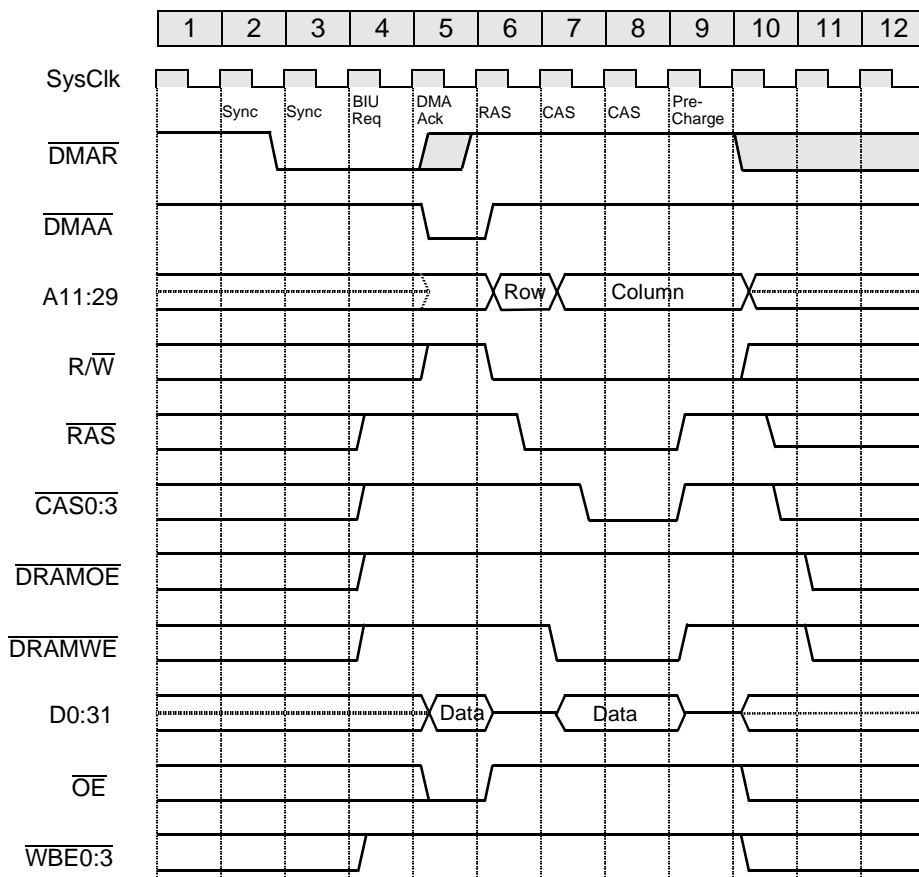

#### Bank Register Bit Settings

SLF	ERM	Bus Width	Ext Mux	RAS-to-CAS	Refresh Mode	Page Mode	First Access	Burst Access	Prechg Cycles	Refresh RAS	Refresh Rate
Bit 13	Bit 14	Bits 15:16	Bit 17	Bit 18	Bit 19	Bit 20	Bits 21:22	Bits 23:24	Bit 25	Bit 26	Bits 27:30
0 or 1	0	10	0	0	0	0	01	xx	0	x	xxxx

#### DMA Control Register Bit Settings

Transfer Direction	Transfer Width	Transfer Mode	Peripheral Setup	Peripheral Wait	Peripheral Hold
Bit 2	Bits 4:5	Bits 9:10	Bits 11:12	Bits 13:18	Bits 19:21
1	10	00	00	00 0000	000

#### Notes:

1. DMAR must be sampled inactive at the start of cycle 9 to guarantee a single transfer.
2. Peripheral data bus width must match DRAM bus width.
3. This waveform assumes that the internal address mux is used.
4. CAS0 is used for byte accesses, CAS0:1 for halfwords, and CAS0:3 for fullwords.

**DMA Fly-By Single Transfer, Write to 3-Cycle DRAM**

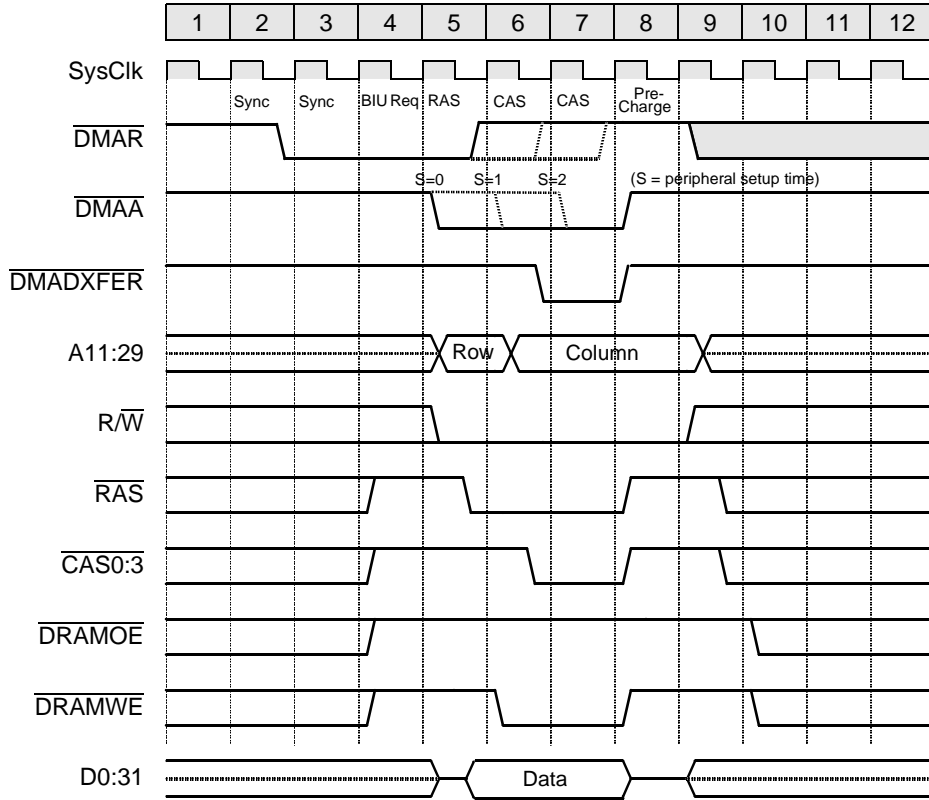

**Bank Register Bit Settings**

SLF	ERM	Bus Width	Ext Mux	RAS-to-CAS	Refresh Mode	Page Mode	First Access	Burst Access	Prechg Cycles	Refresh RAS	Refresh Rate
Bit 13	Bit 14	Bits 15:16	Bit 17	Bit 18	Bit 19	Bit 20	Bits 21:22	Bits 23:24	Bit 25	Bit 26	Bits 27:30
0 or 1	0	10	0	0	0	0	01	xx	0	x	xxxx

**DMA Control Register Bit Settings**

Transfer Direction	Transfer Width	Transfer Mode	Peripheral Setup	Peripheral Wait	Peripheral Hold
Bit 2	Bits 4:5	Bits 9:10	Bits 11:12	Bits 13:18	Bits 19:21
1	10	01	Note 3	xx xxxx	xxx

**Notes:**

1. DMAR must be inactive in cycle 7 (last DMAA cycle) to guarantee a single transfer.
2. Peripheral data bus width must match DRAM bus width.
3. See diagram for settings.
4. This waveform assumes that the internal address mux is used.
5. CAS0 is used for byte accesses, CAS0:1 for halfwords, and CAS0:3 for fullwords.



## IBM PowerPC 403GA

### DMA Fly-By Continuous Burst to 3-Cycle DRAM

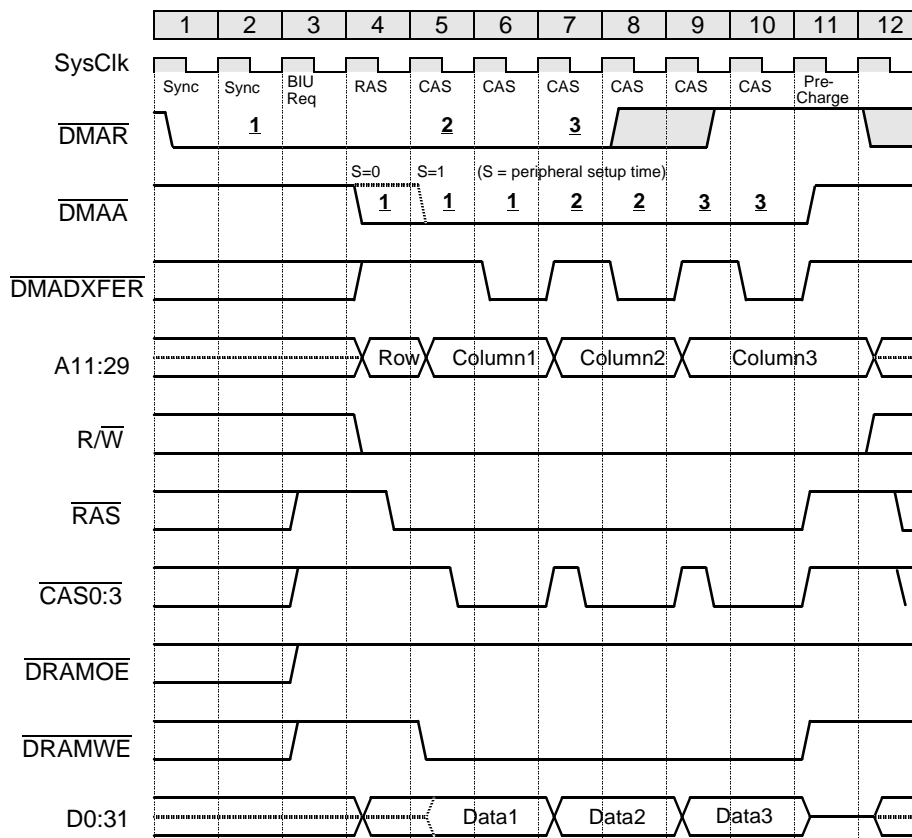

#### Bank Register Bit Settings

SLF	ERM	Bus Width	Ext Mux	RAS-to-CAS	Refresh Mode	Page Mode	First Access	Burst Access	Prechg Cycles	Refresh RAS	Refresh Rate
Bit 13	Bit 14	Bits 15:16	Bit 17	Bit 18	Bit 19	Bit 20	Bits 21:22	Bits 23:24	Bit 25	Bit 26	Bits 27:30
0 or 1	0	10	0	0	0	1	01	01	0	x	xxxx

#### DMA Control Register Bit Settings

Transfer Direction	Transfer Width	Transfer Mode	Peripheral Setup	Peripheral Wait	Peripheral Hold	Burst Mode
Bit 2	Bits 4:5	Bits 9:10	Bits 11:12	Bits 13:18	Bits 19:21	Bit 25
1	10	01	Note 3	xx xxxx	xxx	1

#### Notes:

1. DMAR must be inactive at the end of cycle 9 to guarantee three transfers.
2. Peripheral data bus width must match DRAM bus width.
3. See diagram for settings.
4. This waveform assumes that the internal address mux is used.
5.  $\overline{\text{CAS0}}$  is used for byte accesses,  $\overline{\text{CAS0:1}}$  for halfwords, and  $\overline{\text{CAS0:3}}$  for fullwords.
6. Numbers (1,2,3,...) in the DMAR signal represent when DMAR is sampled and accepted. Numbers (1,2,3,...) in the DMAA signal represent the transfers associated with the accepted DMAR.

**External Master Nonburst DRAM Read with HoldReq/HoldAck**

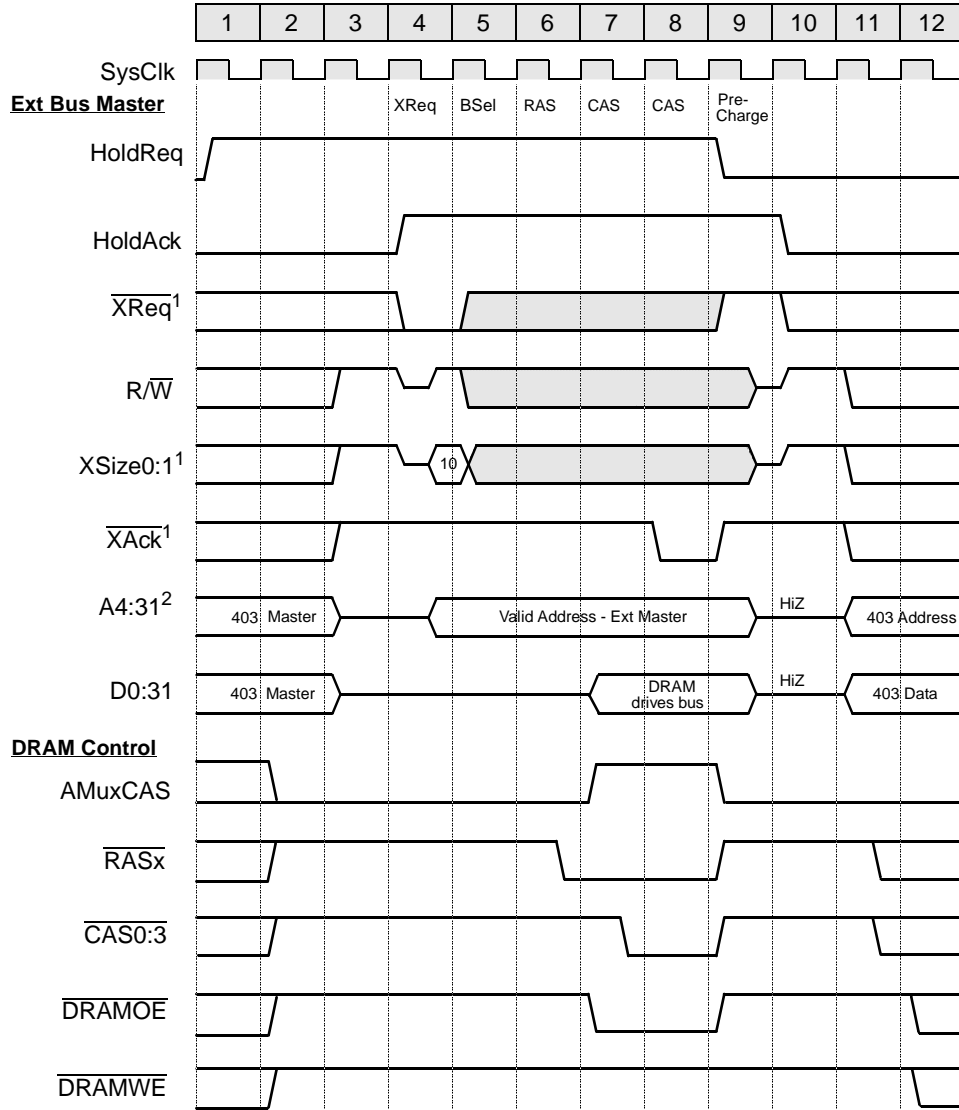

**Bank Register Bit Settings**

SLF	ERM	Bus Width	Ext Mux	RAS-to-CAS	Refresh Mode	Page Mode	First Access	Burst Access	Prechg Cycles	Refresh RAS	Refresh Rate
Bit 13	Bit 14	Bits 15:16	Bit 17	Bit 18	Bit 19	Bit 20	Bits 21:22	Bits 23:24	Bit 25	Bit 26	Bits 27:30
0 or 1	0	10	1	0	0	0	01	xx	0	x	xxxx

**Notes:**

1. XReq, XSize0, XSize1, and XAck are multiplexed with DMAR3, EOT3/TC3, OE, and DMAA3, respectively.
2. A4, A5, A30, and A31 are multiplexed with WBE0, WBE1, WBE2, and WBE3, respectively.

## IBM PowerPC 403GA

### External Master DRAM Burst Write, 3-2-2-2 Page Mode

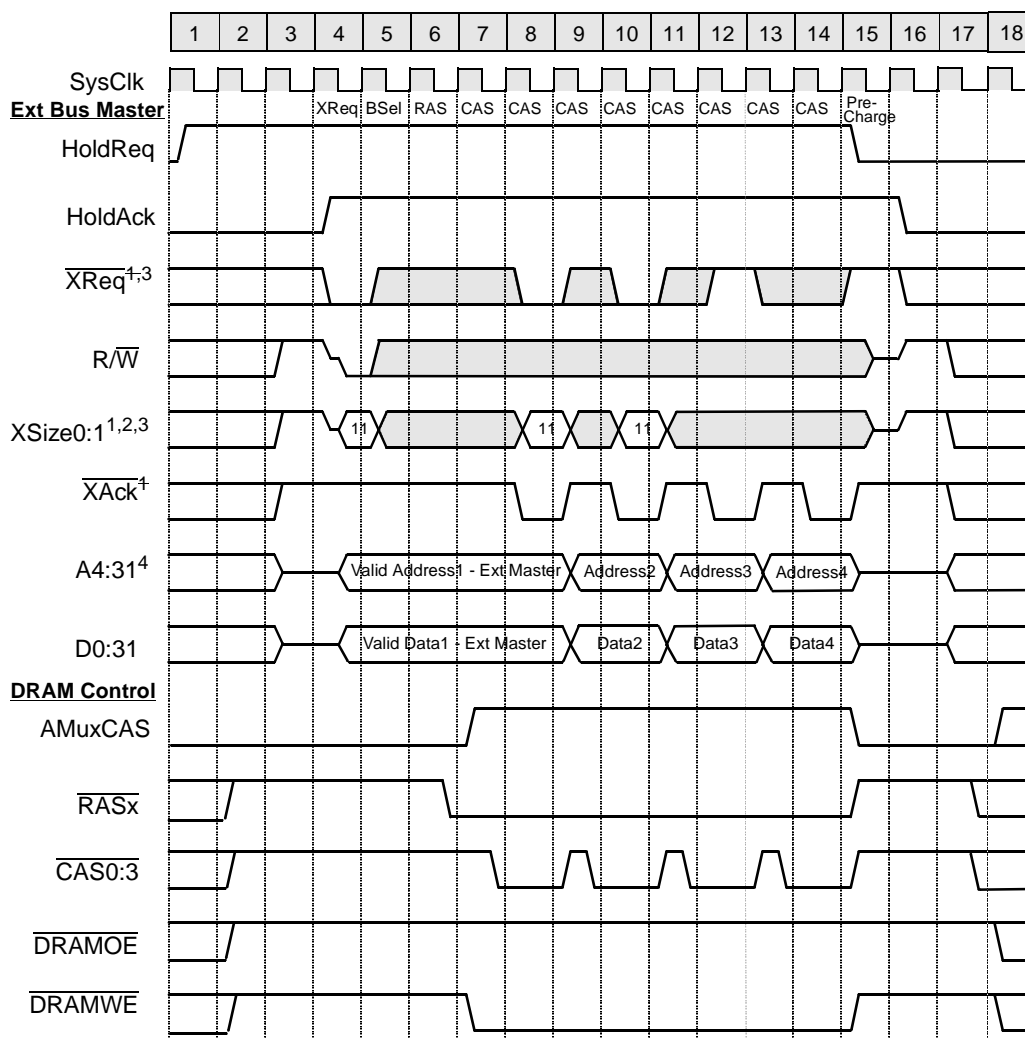

#### Bank Register Bit Settings

SLF	ERM	Bus Width	Ext Mux	RAS-to-CAS	Refresh Mode	Page Mode	First Access	Burst Access	Prechg Cycles	Refresh RAS	Refresh Rate
Bit 13	Bit 14	Bits 15:16	Bit 17	Bit 18	Bit 19	Bit 20	Bits 21:22	Bits 23:24	Bit 25	Bit 26	Bits 27:30
0 or 1	0	10	1	0	0	1	01	01	0	x	xxxx

#### Notes:

1. XReq, XSize0, XSize1, and XAck are multiplexed with DMAR3, EOT3/TC3, OE, and DMAA3, respectively.
2. XSize0:1 = 11 indicates a burst transfer at the width of the DRAM device.
3. The burst is terminated in cycle 12 by deasserting the XReq input signal. A burst may also be terminated by deasserting either XSize0 or XSize1.
4. A4, A5, A30, and A31 are multiplexed with WBE0, WBE1, WBE2, and WBE3, respectively.



© Copyright IBM Corporation 1996,1998. All rights reserved.  
Printed in the USA on recycled paper.  
12-98

IBM Microelectronics, PowerPC, PowerPC Architecture, and 403GA are trademarks, IBM and the IBM logo are registered trademarks of IBM Corporation.

This document may contain preliminary information and is subject to change by IBM without notice. IBM assumes no responsibility of liability for any use of the information contained herein. Nothing in this document shall operate as an express or implied license or indemnity under the intellectual property rights of IBM or third parties. The products described in this document are not intended for use in implantation or other direct life support applications where malfunction may result in direct physical harm or injury to persons. NO WARRANTIES OF ANY KIND, INCLUDING BUT NOT LIMITED TO THE IMPLIED WARRANTIES OF MERCHANTABILITY OR FITNESS FOR A PARTICULAR PURPOSE, ARE OFFERED IN THIS DOCUMENT.

IBM Microelectronics Division  
1580 Route 52, Bldg. 502  
Hopewell Junction, NY 12533-6531  
Tel: (800) PowerPC

12.15.98