

PM300DHA060

Powerex, Inc., Hillis Street, Youngwood, Pennsylvania 15697 (412) 925-7272
 Powerex, Europe, S.A. 428 Avenue G. Durand, BP107, 72003 Le Mans, France (43) 41.14.14

Intellimod™-3 Modules
 Single Phase
 IGBT Inverter Output
 300 Amperes/110-230 Volt Line

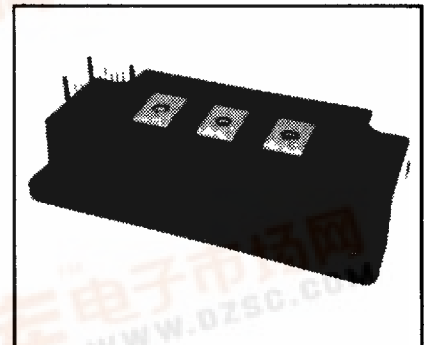
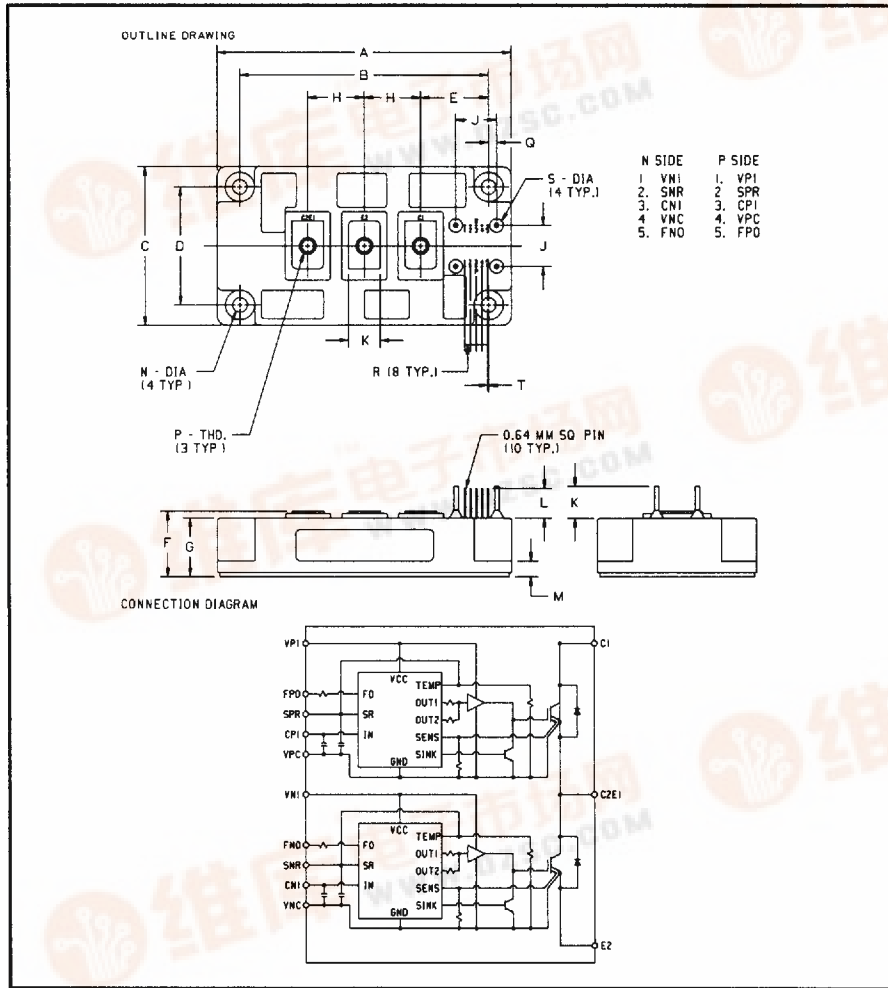

Description

Powerex Intellimod-3 Modules are designed for applications requiring a high frequency (20kHz) output switching inverter. The modules are isolated from the baseplate, consisting of complete drive, control and protection circuitry for the IGBT inverter.

Features:

- Complete Output Power Circuit
- Gate Drive Circuit
- Protection Logic
 - Short Circuit
 - Over-Current
 - Over Temperature
 - Under Voltage

Applications:

- Inverters
- Small UPS
- Motion/Servo Control
- AC Motor Control

Ordering Information
 PM300DHA060

110-230 Volt Line, PM300DHA060 Outline Drawing

Dimensions	Inches	Millimeters
A	5.12	130.0
B	4.33±0.01	110.0±0.25
C	2.76	70.0
D	2.05±0.01	52.0±0.25
E	1.18	30.0
F	1.14+0.04/-0.02	29.0+1.0/-0.5
G	1.02	26.0
H	0.98	25.0
J	0.71	18.0

Dimensions	Inches	Millimeters
K	0.55	14.0
L	0.51	13.0
M	0.28	7.0
N	0.26 Dia.	6.5 Dia.
P	Metric M6	M6
Q	0.14	3.5
R	0.1	2.54
S	0.08 Dia.	2.0 Dia.
T	0.016	0.42





POWEREX INC

51E D ■ 7294621 0005731 8T9 ■ PRX

Powerex, Inc., Hillis Street, Youngwood, Pennsylvania 15697 (412) 925-7272
Powerex, Europe, S.A. 428 Avenue G. Durand, BP107, 72003 Le Mans, France (43) 41.14.14

T-57-29

PM300DHA060
Intellimod-3 Modules
Single Phase IGBT Inverter Output
300 Amperes/110-230 Volt Line

Absolute Maximum Ratings, $T_j = 25\text{ }^\circ\text{C}$ unless otherwise specified

Characteristics	Symbol	PM300DHA060	Units
Power Device Junction Temperature	T_j	-20 to +150	$^\circ\text{C}$
Storage Temperature	T_{STG}	-40 to +125	$^\circ\text{C}$
Case Operating Temperature	T_C	-20 to +100	$^\circ\text{C}$
Mounting Torque, M6 Mounting Screws	—	30	Kg-cm
Mounting Torque, M6 Main Terminal Screws	—	30	Kg-cm
Module Weight (Typical)	—	630	Grams
Supply Voltage Protected by OC and SC ($V_D = 13.5 - 16.5\text{V}$, Inverter Part)	$V_{CC(prot.)}$	400	Volts
Isolation Voltage AC 1 minute, 60Hz	V_{RMS}	2500	Volts

Control Sector

Supply Voltage Applied between ($V_{P1} - V_{PC}, V_{N1} - V_{NC}$)	V_D	20	Volts
Input Voltage Applied between ($C_{P1} - V_{PC}, C_{N1} - V_{NC}$)	V_{CIN}	10	Volts
Fault Output Supply Voltage Applied between ($F_{PO} - V_{PC}, F_{NO} - V_{NC}$)	V_{FO}	20	Volts
Fault Output Current (Sink Current at F_{PO}, F_{NO} Terminals)	I_{FO}	20	mA

IGBT Inverter Sector

Collector-Emitter Voltage	V_{CES}	600	Volts
Collector Current \pm	I_C	300	Amperes
Peak Collector Current \pm	I_{CP}	600	Amperes
Supply Voltage (Applied C1 to E2)	V_{CC}	450	Volts
Supply Voltage (Surge) Applied C1 to E2	$V_{CC(surge)}$	500	Volts
Collector Dissipation	P_C	1140	Watts



POWEREX INC

51E D ■ 7294621 0005732 735 ■ PRX

Powerex, Inc., Hillis Street, Youngwood, Pennsylvania 15697 (412) 925-7272
 Powerex, Europe, S.A. 428 Avenue G. Durand, BP107, 72003 Le Mans, France (43) 41.14.14

T-57-29

PM300DHA060
Intellimod-3 Modules
Single Phase IGBT Inverter Output
 300 Amperes/110-230 Volt Line

Electrical Characteristics, $T_j = 25^\circ\text{C}$ unless otherwise specified

Characteristics	Symbol	Test Conditions	Min.	Typ.	Max.	Units
Control Sector						
Overcurrent Trip Level	OC	$-20^\circ\text{C} \leq T \leq 125^\circ\text{C}$, Fig. 5	396	540	–	Amperes
Short Circuit Trip Level	SC	$-20^\circ\text{C} \leq T \leq 125^\circ\text{C}$, Fig. 5	540	760	–	Amperes
Over Current Delay Time	$t_{\text{off(OC)}}$	$V_D = 15\text{V}$, Fig. 5	–	5	–	μS
Over Temperature Protection	OT	Trip Level	100	110	120	$^\circ\text{C}$
Over Temperature Protection	OT_R	Reset Level	85	95	105	$^\circ\text{C}$
Supply Circuit Under Voltage Protection	UV	Trip Level	11.5	12.0	12.5	Volts
Supply Circuit Under Voltage Protection	UV_R	Reset Level	–	12.5	–	Volts
Supply Voltage	V_D	Applied between $V_{P1} - V_{PC}, V_{N1} - V_{NC}$	13.5	15	16.5	Volts
Circuit Current	I_D	$V_D = 15\text{V}, V_{CIN} = 5\text{V}, V_{N1} - V_{NC}$	–	13	20	mA
	I_D	$V_D = 15\text{V}, V_{CIN} = 5\text{V}, V_{P1} - V_{PC}$	–	13	20	mA
Input On Voltage	$V_{CIN(\text{on})}$	Applied between	1.2	1.5	1.8	Volts
Input Off Voltage	$V_{CIN(\text{off})}$	$C_{P1} - V_{PC}, C_{N1} - V_{NC}$	1.7	2.0	2.3	Volts
PWM Input Frequency	f_{PWM}	3- \emptyset Sinusoidal	–	15	20	kHz
Dead Time	t_{DEAD}	For each Input Pulse	4.0	–	–	μS
		Using example Interface Circuit*	6.0	–	–	μS
Fault Output Current	$I_{\text{FO(H)}}$	$V_D = 15\text{V}, V_{\text{FO}} = 15\text{V}$	–	–	0.01	mA
	$I_{\text{FO(L)}}$	$V_D = 15\text{V}, V_{\text{FO}} = 15\text{V}$	–	10	15	mA
Minimum Fault Output Pulse Width	t_{FO}	$V_D = 15\text{V}$	1.0	1.8	–	mS
SXR Terminal Output Voltage	V_{SXR}	$T_j = 125^\circ\text{C}, R_{\text{IN}} = 6.8\text{k}\Omega, (S_{\text{PR}}, S_{\text{NR}})$	4.5	5.1	5.6	Volts

*See Intellimod-3 Applications Data Section 4.3.



POWEREX INC

SIE D ■ 7294621 0005733 671 ■ PRX

Powerex, Inc., Hillis Street, Youngwood, Pennsylvania 15697 (412) 925-7272
 Powerex, Europe, S.A. 428 Avenue G. Durand, BP107, 72003 Le Mans, France (43) 41.14.14

T-57-29

PM300DHA060
Intellimod-3 Modules
Single Phase IGBT Inverter Output
 300 Amperes/110-230 Volt Line

Electrical Characteristics, $T_j = 25\text{ }^\circ\text{C}$ unless otherwise specified

Characteristics	Symbol	Test Conditions	Min.	Typ.	Max.	Units
IGBT Inverter Sector						
Collector Cutoff Current	I_{CEX}	$V_{CE} = V_{CES}, T_j = 25^\circ\text{C}$, Fig. 4	–	–	1	mA
Collector Cutoff Current	I_{CEX}	$V_{CE} = V_{CES}, T_j = 125^\circ\text{C}$, Fig. 4	–	–	10.0	mA
Diode Forward Voltage	V_{FM}	$-I_C = 300\text{A}, V_{CIN} = 5\text{V}$, Fig. 2	–	1.6	2.5	Volts
Collector Emitter Saturation Voltage	$V_{CE(sat)}$	$V_D = 15\text{V}, V_{CIN} = 0\text{V}, I_C = 300\text{A}$, Fig. 1	–	2.6	3.5	Volts
Collector Emitter Saturation Voltage	$V_{CE(sat)}$	$V_D = 15\text{V}, V_{CIN} = 0\text{V}, I_C = 300\text{A}$, $T_j = 125\text{ }^\circ\text{C}$, Fig. 1	–	2.4	3.4	Volts
Inductive Load Switching Times	t_{on}	$V_D = 15\text{V}, V_{CIN} = 0\text{V}$, $V_{CC} = 300\text{V}, I_C = 300\text{A}$, $T_j = 125\text{ }^\circ\text{C}$ Fig. 3	0.5	1.4	2.5	μS
	t_{rr}		–	0.2	0.4	μS
	$t_{C(on)}$		–	0.5	1.0	μS
	t_{off}		–	2.0	3.0	μS
	$t_{C(off)}$		–	0.5	1.0	μS

Thermal Characteristics

Characteristics	Symbol	Test Conditions	Min.	Typ.	Max.	Units
Thermal Resistances Junction to Case	$R_{th(j-c)Q}$	Inverter IGBT	–	–	0.11	$^\circ\text{C/W}$
	$R_{th(j-c)F}$	Inverter FWD	–	–	0.24	$^\circ\text{C/W}$
Contact Thermal Resistance	$R_{th(c-f)}$	Case to Fin, Thermal Grease Applied	–	–	0.075	$^\circ\text{C/W}$

Recommended Operating Conditions

Characteristics	Symbol	Test Conditions	Value	Units
Supply Voltage	V_{CC}	Applied across C1 - E2 Terminals	0 ~ 400	Volts
	V_D	Applied between $V_{P1} - V_{PC}, V_{N1} - V_{NC}$	15±1.5	Volts
Input On Voltage	$V_{CIN(on)}$	Applied between	0 ~ 0.8	Volts
Input Off Voltage	$V_{CIN(off)}$	$C_{P1} - V_{PC}, C_{N1} - V_{NC}$	4 ~ V_{SXR}	Volts
PWM Input Frequency	f_{PWM}	Using example Interface Circuit *	5 ~ 20	kHz
Minimum Dead Time	t_{DEAD}	Using example Interface Circuit *	6.0	μS

*See Intellimod-3 Applications Data Section 4.3.



POWEREX INC

51E D ■ 7294621 0005734 508 ■ PRX

Powerex, Inc., Hillis Street, Youngwood, Pennsylvania 15697 (412) 925-7272
Powerex, Europe, S.A. 428 Avenue G. Durand, BP107, 72003 Le Mans, France (43) 41.14.14

PM300DHA060
Intellimod-3 Modules
Single Phase IGBT Inverter Output
300 Amperes/110-230 Volt Line

T-57-29

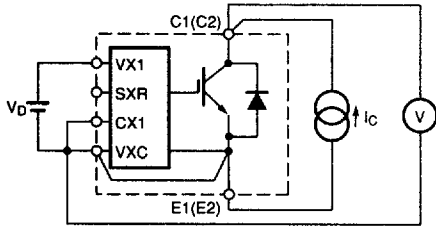

Figure 1 $V_{CE(SAT)}$ Test

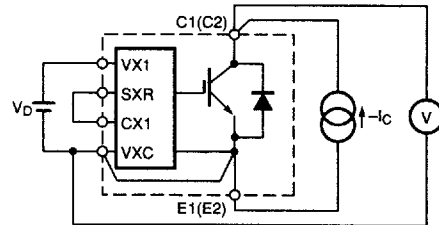

Figure 2 V_{EC} Test

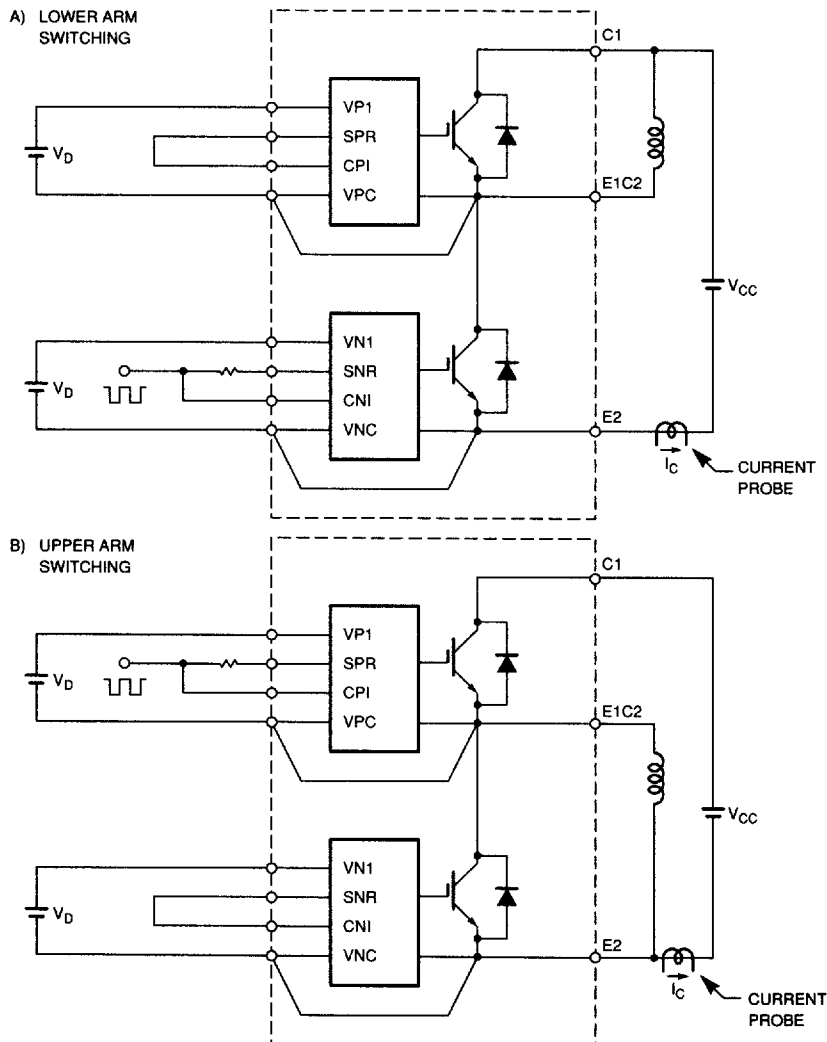

Figure 3 Half Bridge Switching Test and Waveform



POWEREX INC

51E D 729462J 0005735 444 PRX

Powerex, Inc., Hillis Street, Youngwood, Pennsylvania 15697 (412) 925-7272
Powerex, Europe, S.A. 428 Avenue G. Durand, BP107, 72003 Le Mans, France (43) 41.14.14

PM300DHA060
Intellimod-3 Modules
Single Phase IGBT Inverter Output
300 Amperes/110-230 Volt Line

T-57-29

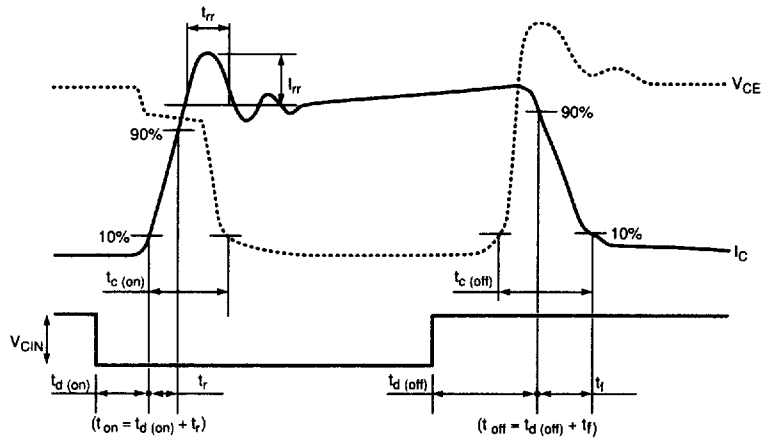

Figure 3 Half Bridge Switching Test and Waveform (Continued)

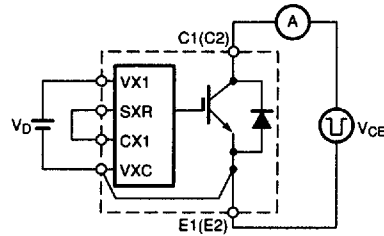

Figure 4 I_{CES} Test

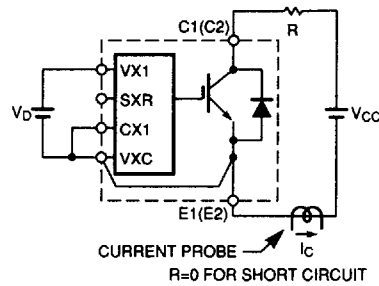

Figure 5 Over Current and Short Circuit Test