

EMI Suppression Filters (EMIFIL[®]) for AC Power Lines



Cat.No.C09E-11

muRata

*Innovator
in Electronics*

Murata
Manufacturing Co., Ltd.

Part Numbering	_____	2
Outline of EMI Suppression Filter (EMIFIL®) for AC Power Lines	_____	3
1 Common Mode Choke Coil	_____	5
FKOB Series	_____	5
PLA10 Series Standard Winding Type	_____	6
PLA10 Series Sectional Winding Type	_____	6
PLA10 Series (Safety Standard Recognized) Standard Winding Type	_____	8
PLA10 Series (Safety Standard Recognized) Sectional Winding Type	_____	8
PLH10 Series	_____	10
PLH10 Series (Safety Standard Recognized)	_____	11
2 Hybrid Choke Coil	_____	12
PLY10 Series Standard Winding Type	_____	12
PLY10 Series Sectional Winding Type	_____	12
PLY10 Series (Safety Standard Recognized) Standard Winding Type	_____	14
PLY10 Series (Safety Standard Recognized) Sectional Winding Type	_____	14
PLY17 Series A Type	_____	16
PLY17 Series B Type	_____	16
PLY17 Series (Safety Standard Recognized) A Type	_____	18
PLY17 Series (Safety Standard Recognized) B Type	_____	18
● Noise Suppression Effect of PLY10 Series	_____	20
⚠Caution /Notice	_____	21
Packaging	_____	22

(Part Number)

PL	A	10	A	S	152	2R0	R	2	B
1	2	3	4	5	6	7	8	9	10

① Product ID

Product ID	
PL	Common Mode Choke Coils

② Type

Code	Type
A	AC Standard Type
H	AC High-frequency Type
Y	AC Hybrid Choke Coils Type

③ Applications

Code	Applications
10	for AC Line
17	

④ Structure

Code	Structure
A	Core Vertical Type
B	Core Horizontal Type

⑤ Features

Code	Features
S	Safety Recognized
N	General Use

⑩ Packaging

Code	Packaging	Series
B	Bulk	All series
M	Magazine Package	

• Please contact us for **FKOB** series.

⑥ Inductance

Expressed by three figures. The unit is micro-henry (μH). The first and second figures are significant digits, and the third figure expresses the number of zeros which follow the two figures. If there is a decimal point, it is expressed by the capital letter "R". In this case, all figures are significant digits. If inductance is less than $0.1 \mu\text{H}$, the inductance code is expressed by a combination of two figures and capital letter "N", and the unit of inductance is nano-henry (nH). The capital letter "N" indicates the unit of "nH", and also expresses a decimal point. In this case, all figures are significant digits.

⑦ Rated Current

Expressed by three figures. The unit is in amperes (A). A decimal point is expressed by the capital letter "R". In this case, all figures are significant digits.

⑧ Winding Mode

Code	Winding Mode
A	Parallel Winding Type
B	Parallel Winding Type (High Performance Type)
D	Sectional Winding Type
R	Standard Type
P	Single Layer Winding Type

⑨ Lead Dimensions

Code	Lead Dimensions
2	3.5mm







power lines eliminate noise entering equipment from commercial power lines or noise generated from electronic equipment.

Common mode chokes, line bypass capacitors, across the line capacitors are generally used as AC EMI suppression filter device. In suppressing common mode noise, common mode chokes are most important devices. Because the characteristics of common mode chokes influences

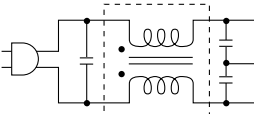
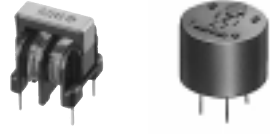
of common mode chokes. (Standard type, High frequency type)

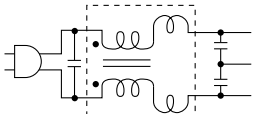
Hybrid choke coil is high performance EMI suppression device which can suppress both common mode noise differential mode noise at the same time. It is effective power supplies with active device for higher harmonic countermeasure, which tend to emit relatively higher differential mode noise.

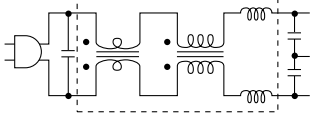
■ Classification of EMI Suppression Filter for AC Power Lines

Product Name	Appearance	Effective Frequency Range (Hz)						Application
		10k	100k	1M	10M	100M	1G	
Common Mode Choke Coil 	Standard Type  PLA10 FKOB							Suppression of general common mode noise
	High Frequency Type  PLH10							Suppression of common mode noise contains high frequency noise above 10MHz
Hybrid Choke Coil 	 PLY10							Suppression of conducted noise in AC power line with active device for higher harmonic countermeasure. Suppression of AC power noise which contains both common mode noise and differential mode noise.
Hybrid Choke Coil 	 PLY17							For AC power supply, AC adaptor. Set for low profile equipment.

Standard Winding

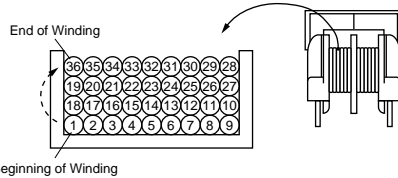

High-frequency noise can pass through the Filter easily because both edges of coils are close as shown above

Sectional Winding

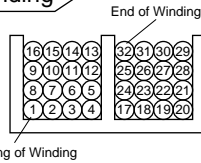

High-frequency noise can hardly pass through the Filter because both edges of coil are not close as shown above

Standard Winding

Large inductance is available
→ Highly Efficient in Low Frequency

Sectional Winding

Excellent performance in high frequency
Stray capacity between windings is low

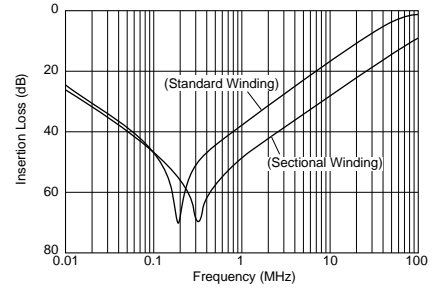

■ Noise Measures for Switching Power Supply

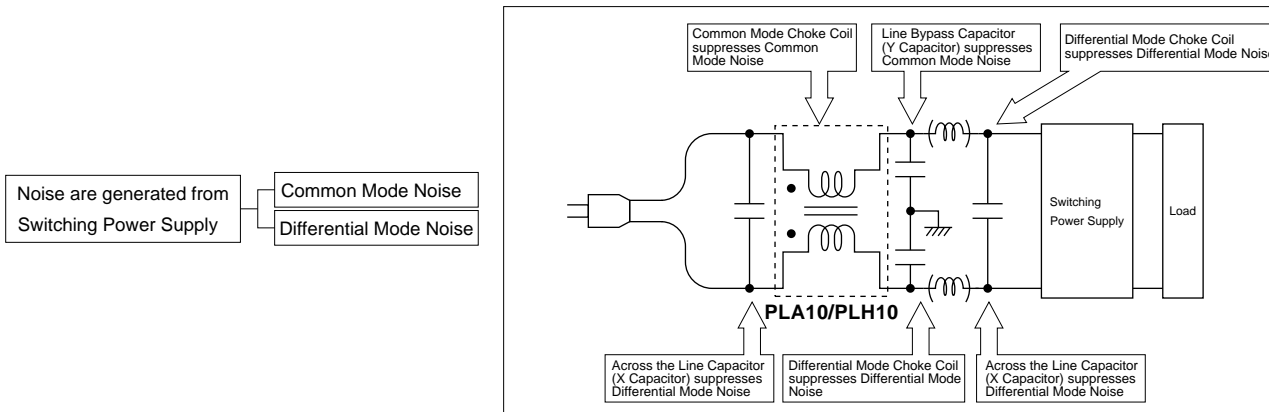

FKOB Series

The FKOB series is compact size AC common mode choke coil which uses toroidal type ferrite core. Its broad band frequency characteristic enables simple filter composition in relative low noise equipments.

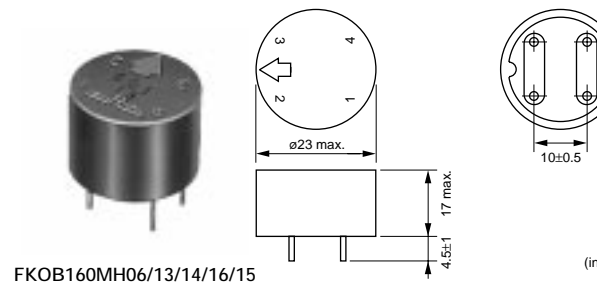
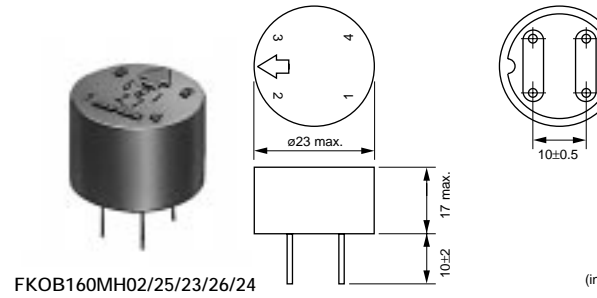

Part Number	Common Mode Inductance (min.) (μH)	Rated Current (A)	Rated Voltage (V)	Insulation Resistance (min.) (M ohm)
FKOB160MH02	250	2.5	250	100
FKOB160MH06	250	2.5	250	100
FKOB160MH13	600	2.5	250	100
FKOB160MH25	600	2.5	250	100
FKOB160MH14	800	2.5	250	100
FKOB160MH23	800	2.5	250	100
FKOB160MH16	1000	1.5	250	100
FKOB160MH26	1000	1.5	250	100
FKOB160MH15	1500	1.5	250	100
FKOB160MH24	1500	1.5	250	100

Operating Temperature Range (Ambient Temperature Range + Winding Temperature Rise): -20°C to 95°C Winding Temperature Rise (at Rated Current) (max.): 30°C

Equivalent Circuit Diagram

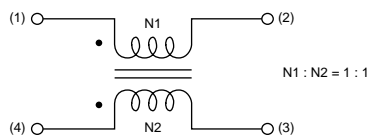

Insertion Loss-Frequency Characteristics

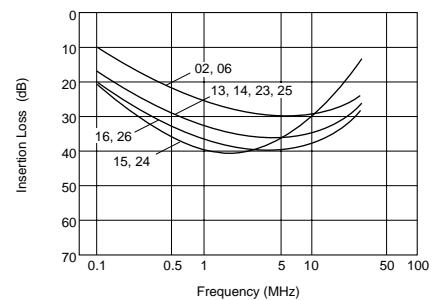

choke coil. It can obtain a high inductance value in spite of its compact size.

■ Features

1. Compact and light weight
2. Low profile in vertical core layout
3. Both a standard winding type and a sectional winding type for higher frequency noise are available.

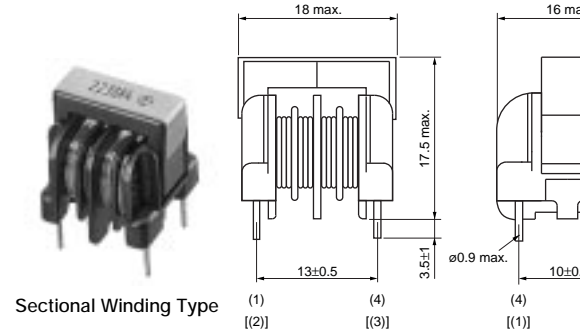
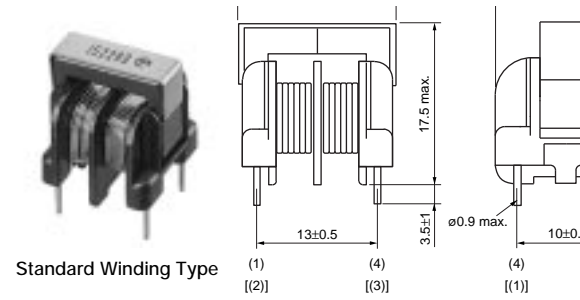

● Standard Winding Type

Part Number	Common Mode Inductance (min.) (mH)	Rated Current (A)	Rated Voltage (V)	Insulation Resistance (min.) (M ohm)
PLA10AN1522R0R2	1.5	2.0	300	100
PLA10AN1821R7R2	1.8	1.7	300	100
PLA10AN2221R5R2	2.2	1.5	300	100
PLA10AN3021R3R2	3.0	1.3	300	100
PLA10AN3521R2R2	3.5	1.2	300	100
PLA10AN5521R0R2	5.5	1.0	300	100
PLA10AN7420R8R2	7.4	0.8	300	100
PLA10AN1030R7R2	10.0	0.7	300	100
PLA10AN1230R6R2	12.0	0.6	300	100
PLA10AN2030R5R2	20.0	0.5	300	100
PLA10AN3030R4R2	30.0	0.4	300	100
PLA10AN4330R3R2	43.0	0.3	300	100

Operating Temperature Range (Ambient Temperature Range + Winding Temperature Rise): -25°C to 120°C Winding Temperature Rise (at Rated Current) (max.): 60°C

● Sectional Winding Type

Part Number	Common Mode Inductance (min.) (mH)	Rated Current (A)	Rated Voltage (V)	Insulation Resistance (min.) (M ohm)
PLA10AN9012R0D2	0.9	2.0	300	100
PLA10AN1321R7D2	1.3	1.7	300	100
PLA10AN1821R5D2	1.8	1.5	300	100
PLA10AN2021R3D2	2.0	1.3	300	100
PLA10AN3621R0D2	3.6	1.0	300	100
PLA10AN7720R7D2	7.7	0.7	300	100
PLA10AN1330R5D2	13.0	0.5	300	100
PLA10AN2230R4D2	22.0	0.4	300	100
PLA10AN3630R3D2	36.0	0.3	300	100

Operating Temperature Range (Ambient Temperature Range + Winding Temperature Rise): -25°C to 120°C Winding Temperature Rise (at Rated Current) (max.): 60°C

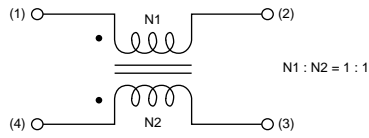

■ Insertion Loss-Frequency Characteristics

Standard Winding Type

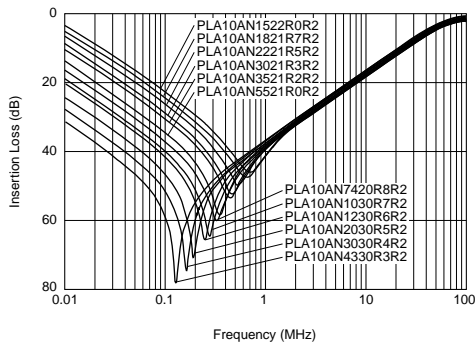

Sectional Winding Type

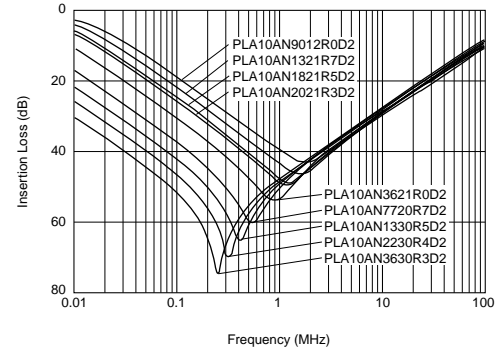

1. Compact and light weight
2. Low profile in vertical core layout
3. Both a standard winding type and a sectional winding type for higher frequency noise are available.
4. Safety standards: EN60065

■ Applications

Noise suppression of AC power lines

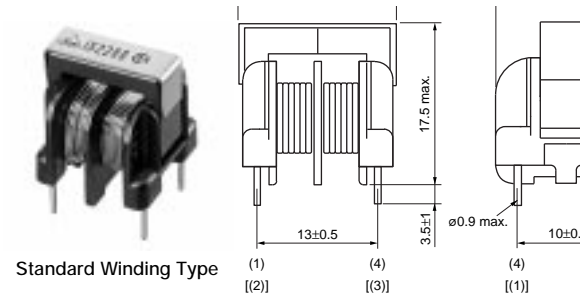

Standard Winding Type

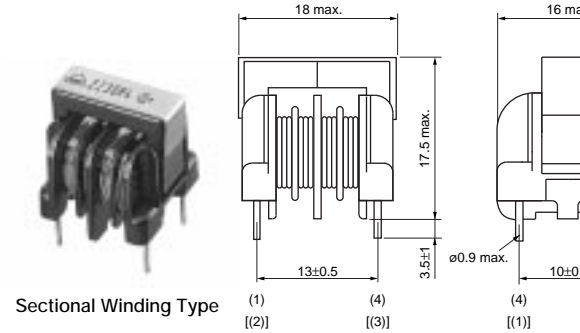

Sectional Winding Type

● Standard Winding Type

Part Number	Common Mode Inductance (min.) (mH)	Rated Current (A)	Rated Voltage (V)	Insulation Resistance (min.) (M ohm)
PLA10AS1522R0R2	1.5	2.0	250	100
PLA10AS1821R7R2	1.8	1.7	250	100
PLA10AS2221R5R2	2.2	1.5	250	100
PLA10AS3021R3R2	3.0	1.3	250	100
PLA10AS3521R2R2	3.5	1.2	250	100
PLA10AS5521R0R2	5.5	1.0	250	100
PLA10AS7420R8R2	7.4	0.8	250	100
PLA10AS1030R7R2	10.0	0.7	250	100
PLA10AS1230R6R2	12.0	0.6	250	100
PLA10AS2030R5R2	20.0	0.5	250	100
PLA10AS3030R4R2	30.0	0.4	250	100
PLA10AS4330R3R2	43.0	0.3	250	100

Operating Temperature Range : -25°C to 60°C Winding Temperature Rise (at Rated Current) (max.): 60K

● Sectional Winding Type

Part Number	Common Mode Inductance (min.) (mH)	Rated Current (A)	Rated Voltage (V)	Insulation Resistance (min.) (M ohm)
PLA10AS9012R0D2	0.9	2.0	250	100
PLA10AS1321R7D2	1.3	1.7	250	100
PLA10AS1821R5D2	1.8	1.5	250	100
PLA10AS2021R3D2	2.0	1.3	250	100
PLA10AS3621R0D2	3.6	1.0	250	100
PLA10AS7720R7D2	7.7	0.7	250	100
PLA10AS1330R5D2	13.0	0.5	250	100
PLA10AS2230R4D2	22.0	0.4	250	100
PLA10AS3630R3D2	36.0	0.3	250	100

Operating Temperature Range : -25°C to 60°C Winding Temperature Rise (at Rated Current) (max.): 60K

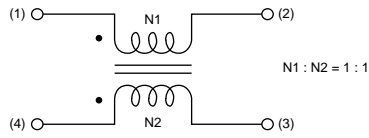

■ Insertion Loss-Frequency Characteristics

Standard Winding Type

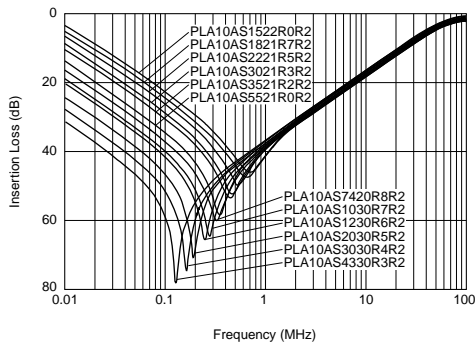

Sectional Winding Type

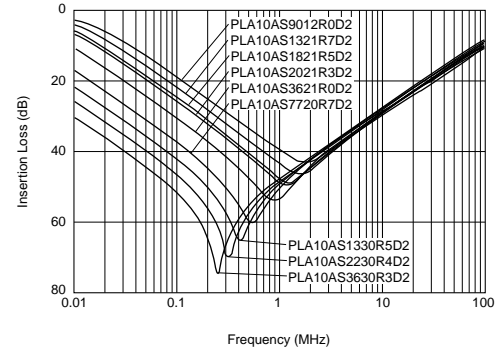

frequency use. The same dimensions as the PLA10 series enables flexible design.

■ Features

1. High performance in high frequency range
2. Low profile in vertical core layout
3. Compact and light weight

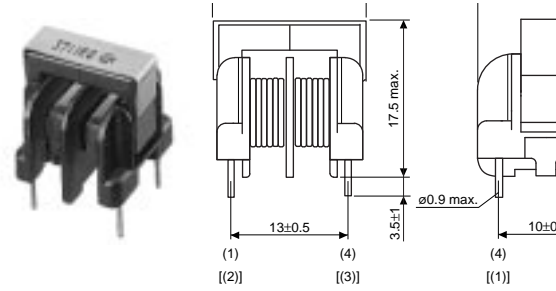

Part Number	Common Mode Inductance (min.) (μH)	Rated Current (A)	Rated Voltage (V)	Insulation Resistance (min.) (M ohm)
PLH10AN7003R6P2	70	3.6	300	100
PLH10AN1112R6P2	110	2.6	300	100
PLH10AN1612R1P2	160	2.1	300	100
PLH10AN2211R5P2	220	1.5	300	100
PLH10AN2911R2P2	290	1.2	300	100
PLH10AN3711R0P2	370	1.0	300	100

Operating Temperature Range (Ambient Temperature Range + Winding Temperature Rise): -25°C to 120°C Winding Temperature Rise (at Rated Current) (max.):

■ Equivalent Circuit Diagram

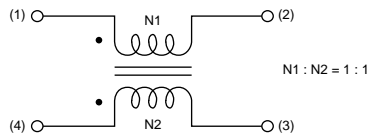

■ Insertion Loss-Frequency Characteristics

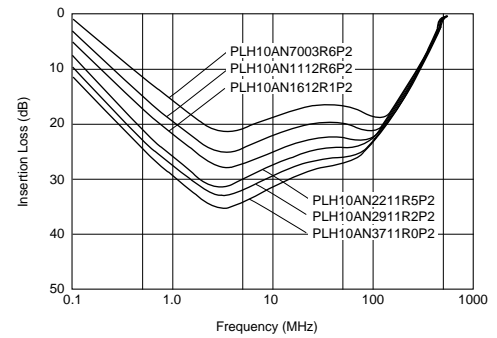

1. High performance in high frequency range
2. Low profile in vertical core layout
3. Compact and light weight
4. Safety standards: EN60065

■ Applications

Suppressing radiation noise in switching power supply and inverter (AC-AC converter)

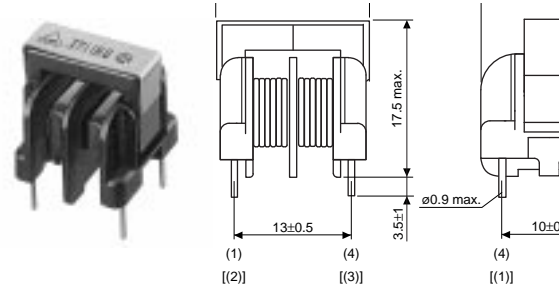

Part Number	Common Mode Inductance (min.) (μH)	Rated Current (A)	Rated Voltage (V)	Insulation Resistance (min.) (M ohm)
PLH10AS7003R6P2	70	3.6	250	100
PLH10AS1112R6P2	110	2.6	250	100
PLH10AS1612R1P2	160	2.1	250	100
PLH10AS2211R5P2	220	1.5	250	100
PLH10AS2911R2P2	290	1.2	250	100
PLH10AS3711R0P2	370	1.0	250	100

Operating Temperature Range : -25°C to 60°C Winding Temperature Rise (at Rated Current) (max.): 60K

■ Equivalent Circuit Diagram

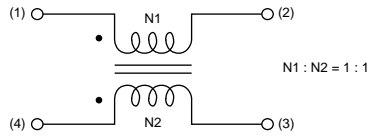

■ Insertion Loss-Frequency Characteristics

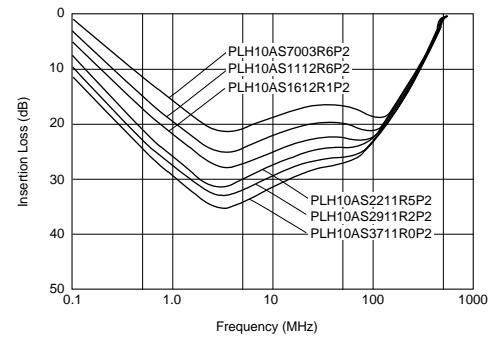

PLY10 Series

The PLY10 is a compact and high performance hybrid choke coil which can handle differential mode noise caused by the harmonics currents regulation circuit as well as common mode noise. It can handle noise problems much more compactly than a combination of a conventional common mode choke coil and a differential mode choke coil.

■ Features

1. PLY10 has both functions of a common mode choke coil and a differential mode choke coil in its compact body.
2. Low profile in vertical core layout
3. PLY10 has the same pin layout as a general type common mode choke coil which enables it to replace conventional components.
4. Both a standard winding type and a sectional winding type for higher frequency noise are available.

■ EMI Problem for harmonics currents regulation

There are some methods meet harmonics currents regulations (IEC1000-3, EN60555-2) such as an active filter type and one converter type. However, they cause new EMI problems of differential mode noise because they use active components. For that reason, additional filter components to meet differential mode noise must be applied.

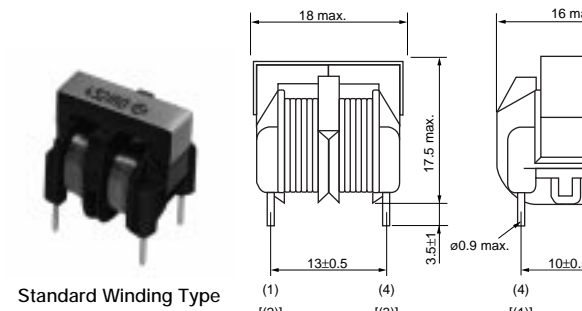

Standard Winding Type

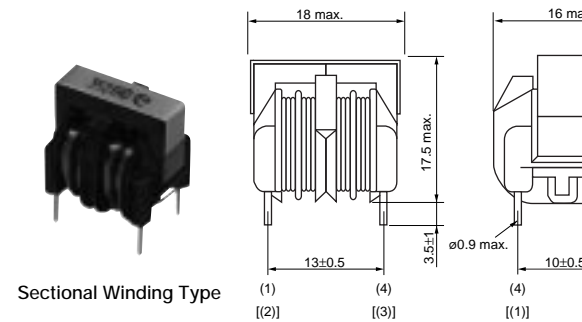

Sectional Winding Type

● Standard Winding Type

Part Number	Common Mode Inductance (min.) (mH)	Normal Mode Inductance (min.) (μ H)	Rated Current (A)	Rated Voltage (Vac)
PLY10AN9012R0R2	0.9	65	2.0	300
PLY10AN1121R8R2	1.1	90	1.8	300
PLY10AN1521R6R2	1.5	110	1.6	300
PLY10AN2121R4R2	2.1	150	1.4	300
PLY10AN2821R2R2	2.8	190	1.2	300
PLY10AN4321R0R2	4.3	300	1.0	300
PLY10AN6220R8R2	6.2	400	0.8	300
PLY10AN8720R7R2	8.7	530	0.7	300
PLY10AN9920R6R2	9.9	690	0.6	300
PLY10AN1430R5R2	14.0	1000	0.5	300

Operating Temperature (Ambient Temperature Range+Winding Temperature Rise): -25°C to 120°C

Winding Temperature Rise (at Rated Current) (max.): 60K

● Sectional Winding Type

Part Number	Common Mode Inductance (min.) (mH)	Normal Mode Inductance (min.) (μ H)	Rated Current (A)	Rated Voltage (Vac)
PLY10AN7012R0D2	0.7	50	2.0	300
PLY10AN1121R7D2	1.1	65	1.7	300
PLY10AN1421R4D2	1.4	110	1.4	300

Continued on the following page

PLY10AN4420R8D2	4.4	320	0.8	300
PLY10AN8720R7D2	8.7	500	0.7	300
PLY10AN9720R6D2	9.7	670	0.6	300
PLY10AN1130R5D2	11.0	840	0.5	300
PLY10AN2430R4D2	24.0	1800	0.4	300

Operating Temperature (Ambient Temperature Range+Winding Temperature Rise): -25°C to 120°C

Winding Temperature Rise (at Rated Current) (max.): 60K

Equivalent Circuit Diagram

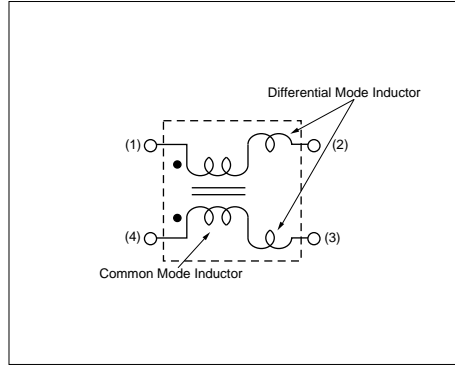

Common Mode Insertion Loss-Frequency Characteristics

Standard Winding Type

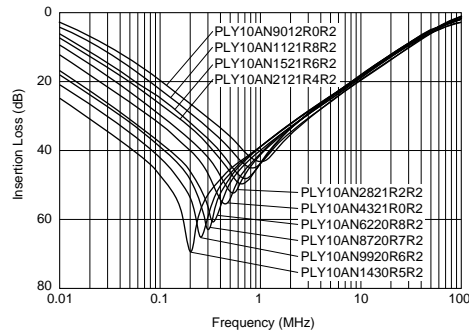

Sectional Winding Type

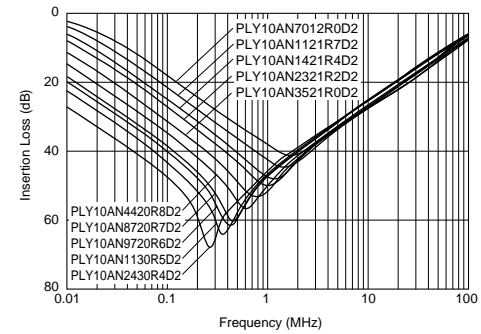

Differential Mode Insertion Loss-Frequency Characteristics

Standard Winding Type

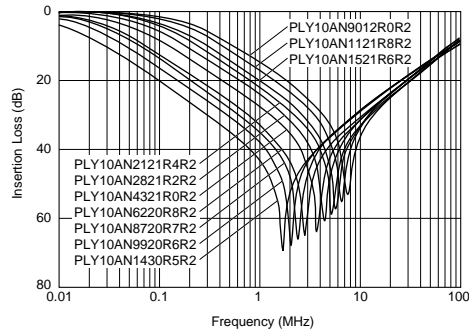

Sectional Winding Type

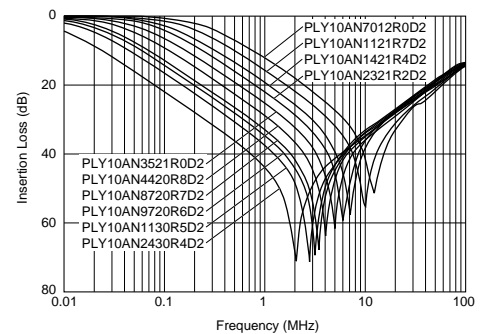

choke coil which can handle differential mode noise caused by the harmonics currents regulation circuit as well as common mode noise. It can handle noise problems much more compactly than a combination of a conventional common mode choke coil and a differential mode choke coil.

■ Features

1. PLY10 has both functions of a common mode choke coil and a differential mode choke coil in its compact body.
2. Low profile in vertical core layout
3. PLY10 has the same pin layout as a general type common mode choke coil which enables it to replace conventional components.
4. Safety standards: EN60065

■ EMI Problem for harmonics currents regulation

There are some methods meet harmonics currents regulations (IEC1000-3, EN60555-2) such as an active filter type and one converter type. However, they cause new EMI problems of differential mode noise because they use active components. For that reason, additional filter components to meet differential mode noise must be applied.

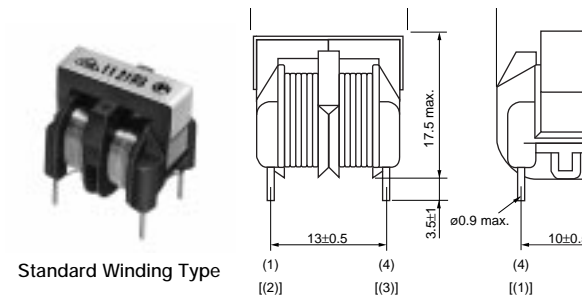

Standard Winding Type

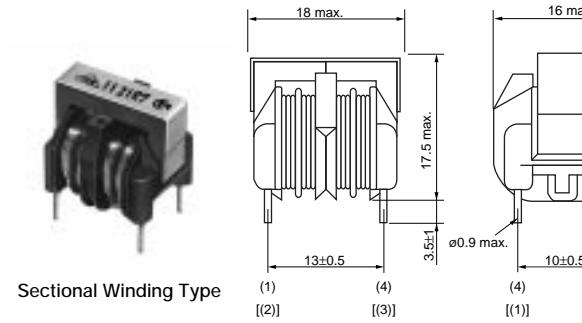

Sectional Winding Type

● Standard Winding Type

Part Number	Common Mode Inductance (min.) (mH)	Normal Mode Inductance (min.) (μH)	Rated Current (A)	Rated Voltage (Vac)
PLY10AS9012R0R2	0.9	65	2.0	300
PLY10AS1121R8R2	1.1	90	1.8	300
PLY10AS1521R6R2	1.5	110	1.6	300
PLY10AS2121R4R2	2.1	150	1.4	300
PLY10AS2821R2R2	2.8	190	1.2	300
PLY10AS4321R0R2	4.3	300	1.0	300
PLY10AS6220R8R2	6.2	400	0.8	300
PLY10AS8720R7R2	8.7	530	0.7	300
PLY10AS9920R6R2	9.9	690	0.6	300
PLY10AS1430R5R2	14.0	1000	0.5	300

Operating Temperature (Ambient Temperature Range+Winding Temperature Rise): -25°C to 120°C

Winding Temperature Rise (at Rated Current) (max.): 60K

● Sectional Winding Type

Part Number	Common Mode Inductance (min.) (mH)	Normal Mode Inductance (min.) (μH)	Rated Current (A)	Rated Voltage (Vac)
PLY10AS7012R0D2	0.7	50	2.0	300
PLY10AS1121R7D2	1.1	65	1.7	300
PLY10AS1421R4D2	1.4	110	1.4	300
PLY10AS2321R2D2	2.3	160	1.2	300
PLY10AS3521R0D2	3.5	240	1.0	300
PLY10AS4420R8D2	4.4	320	0.8	300
PLY10AS8720R7D2	8.7	500	0.7	300
PLY10AS9720R6D2	9.7	670	0.6	300
PLY10AS1130R5D2	11.0	840	0.5	300
PLY10AS2430R4D2	24.0	1800	0.4	300

Operating Temperature (Ambient Temperature Range+Winding Temperature Rise): -25°C to 120°C

Winding Temperature Rise (at Rated Current) (max.): 60K

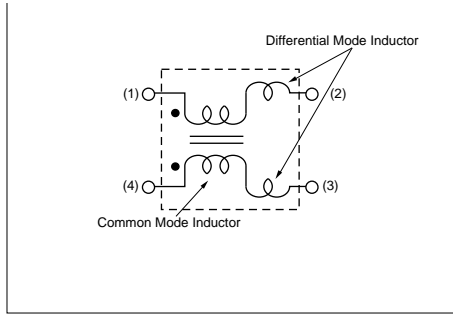

Common Mode Insertion Loss-Frequency Characteristics

Standard Winding Type

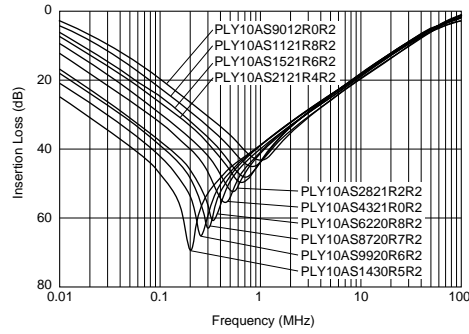

Sectional Winding Type

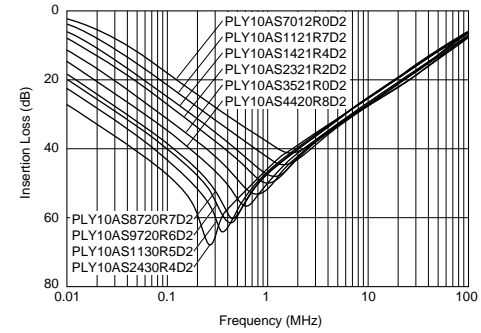

Differential Mode Insertion Loss-Frequency Characteristics

Standard Winding Type

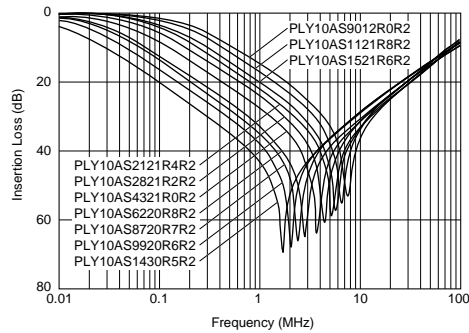

Sectional Winding Type

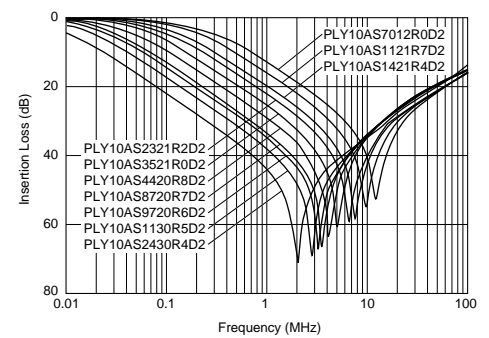

1. Integration of choke coil function to suppress differential mode/Low and High Frequency common mode noise.
2. Low Profile ($H < 13\text{mm}$)

■ Applications

1. For AC power supply, AC adapter
2. Low profile equipment such as lighting equipment, FPD, Digital Amplifier



A/B Type

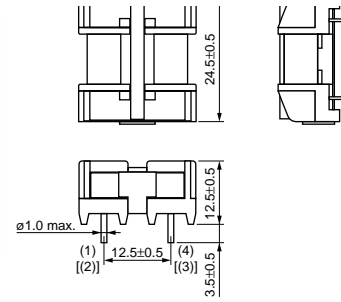

● A Type

Part Number	Common Mode Inductance (min.) (mH)	Normal Mode Inductance (min.) (μH)	Rated Current (A)	Rated Voltage (Vac)
PLY17BN4912R4A2	0.49	18	2.4	300
PLY17BN9612R0A2	0.96	36	2.0	300
PLY17BN1023R0A2	1.0	36	3.0	300
PLY17BN1121R8A2	1.1	44	1.8	300
PLY17BN1721R5A2	1.7	67	1.5	300
PLY17BN2921R2A2	2.9	110	1.2	300
PLY17BN3721R0A2	3.7	140	1.0	300
PLY17BN5620R8A2	5.6	210	0.8	300
PLY17BN7820R7A2	7.8	290	0.7	300
PLY17BN9320R6A2	9.3	350	0.6	300

Operating Temperature (Ambient Temperature Range+Winding Temperature Rise): -25°C to 120°C Winding Temperature Rise (at Rated Current) (max.): 60K

● B Type

Part Number	Common Mode Inductance (min.) (mH)	Normal Mode Inductance (min.) (μH)	Rated Current (A)	Rated Voltage (Vac)
PLY17BN4912R4B2	0.49	24	2.4	300
PLY17BN9612R0B2	0.96	47	2.0	300
PLY17BN1023R0B2	1.0	47	3.0	300
PLY17BN1121R8B2	1.1	58	1.8	300
PLY17BN1721R5B2	1.7	88	1.5	300
PLY17BN2921R2B2	2.9	140	1.2	300
PLY17BN3721R0B2	3.7	180	1.0	300
PLY17BN5620R8B2	5.6	280	0.8	300
PLY17BN7820R7B2	7.8	390	0.7	300
PLY17BN9320R6B2	9.3	460	0.6	300

Operating Temperature (Ambient Temperature Range+Winding Temperature Rise): -25°C to 120°C Winding Temperature Rise (at Rated Current) (max.): 60K

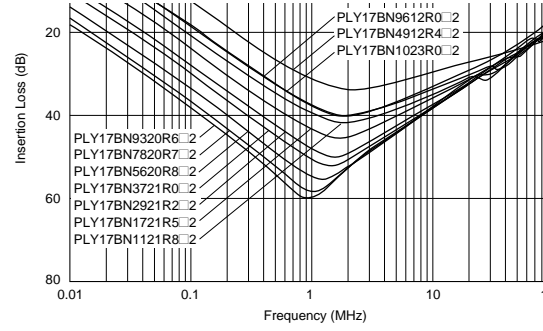
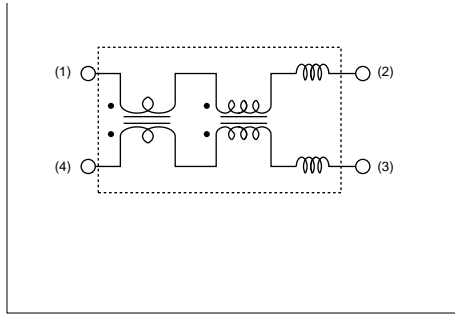

■ Differential Mode Insertion Loss-Frequency Characteristics

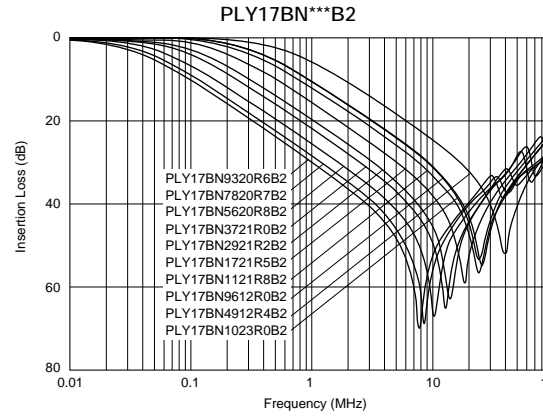
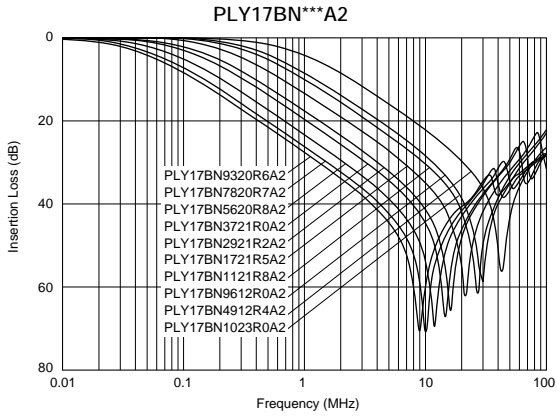

1. Integration of choke coil function to suppress differential mode/Low and High Frequency common mode noise.
2. Low Profile ($H < 13\text{mm}$)
3. Safety standards: EN60065



A/B Type

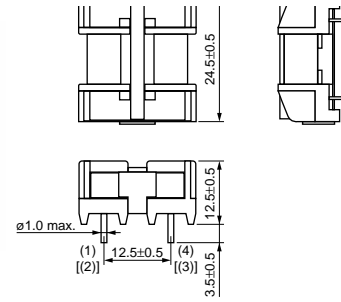

■ Applications

1. For AC power supply, AC adapter
2. Low profile equipment such as lighting equipment, FPD, Digital Amplifier

● A Type

Part Number	Common Mode Inductance (min.) (mH)	Normal Mode Inductance (min.) (μH)	Rated Current (A)	Rated Voltage (Vac)
PLY17BS4912R4A2	0.49	18	2.4	250
PLY17BS9612R0A2	0.96	36	2.0	250
PLY17BS1023R0A2	1.0	36	3.0	250
PLY17BS1121R8A2	1.1	44	1.8	250
PLY17BS1721R5A2	1.7	67	1.5	250
PLY17BS2921R2A2	2.9	110	1.2	250
PLY17BS3721R0A2	3.7	140	1.0	250
PLY17BS5620R8A2	5.6	210	0.8	250
PLY17BS7820R7A2	7.8	290	0.7	250
PLY17BS9320R6A2	9.3	350	0.6	250

Operating Temperature (Ambient Temperature Range+Winding Temperature Rise): -25°C to 120°C Winding Temperature Rise (at Rated Current) (max.): 60K

● B Type

Part Number	Common Mode Inductance (min.) (mH)	Normal Mode Inductance (min.) (μH)	Rated Current (A)	Rated Voltage (Vac)
PLY17BS4912R4B2	0.49	24	2.4	250
PLY17BS9612R0B2	0.96	47	2.0	250
PLY17BS1023R0B2	1.0	47	3.0	250
PLY17BS1121R8B2	1.1	58	1.8	250
PLY17BS1721R5B2	1.7	88	1.5	250
PLY17BS2921R2B2	2.9	140	1.2	250
PLY17BS3721R0B2	3.7	180	1.0	250
PLY17BS5620R8B2	5.6	280	0.8	250
PLY17BS7820R7B2	7.8	390	0.7	250
PLY17BS9320R6B2	9.3	460	0.6	250

Operating Temperature (Ambient Temperature Range+Winding Temperature Rise): -25°C to 120°C Winding Temperature Rise (at Rated Current) (max.): 60K

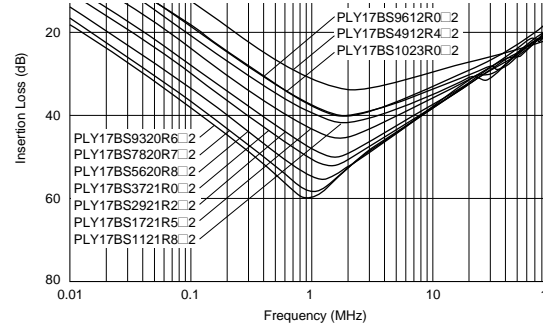
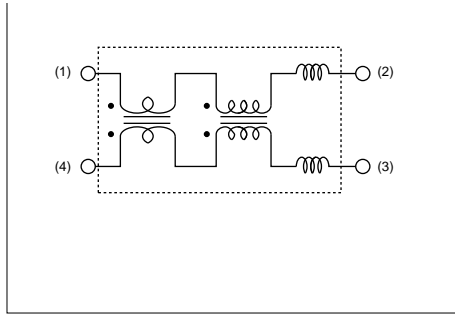

■ Differential Mode Insertion Loss-Frequency Characteristics

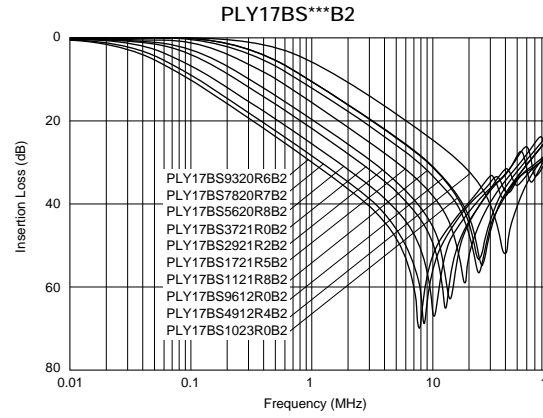
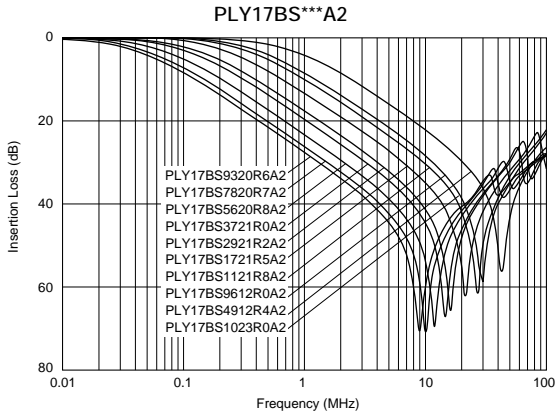

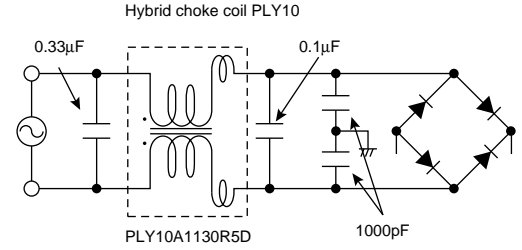
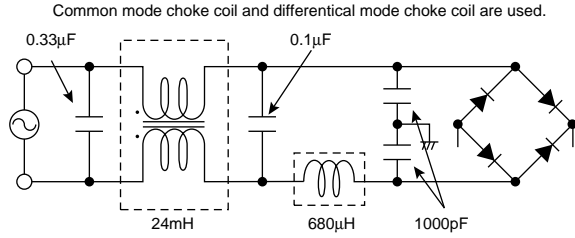
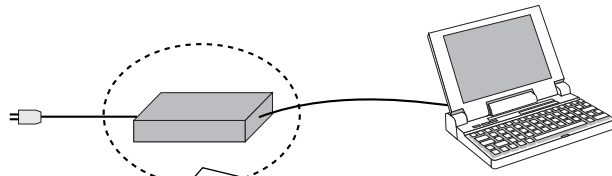

• Noise Level

The filter circuit with hybrid choke coil has suppressed conducted noise as well as conventional filter in spite of its composition.

Common mode choke coil and differential mode choke coil are used.

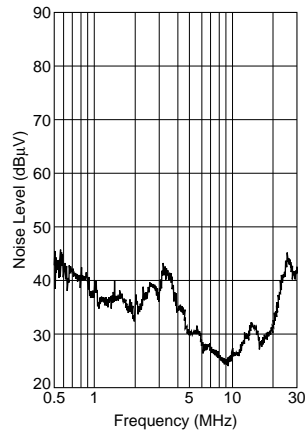

Hybrid choke coil PLY10

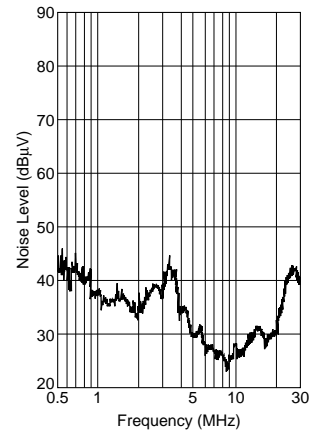

1. Rated Current

Operating current should not exceed the rated value. Even if operating current is under the rated value, adequate ventilation is required to avoid excessive heat generated within the product (choke coil) and from surrounding heat sources. If exceeding these conditions, excessive heat may cause fumes or permanent damage to the product. Please ensure that product (choke coil) is evaluated and confirmed against the specification when it is mounted in your final assembled product.
 -> Winding temperature should be less than 120 degree C.

*As for FKOB series winding temperature should be less than 95 degree C.

Maximum allowable temperature at the surface of coil (ambient temperature + winding temperature rise) is in accordance with each safety standard applicable to final assembled product. When the temperature at winding exceeds maximum allowable temperature of safety standard, the rated current should be derated.

2. Inrush Current

Inrush current should not exceed 10 times rated current within 1/4 cycle of 50/60Hz commercial power line. Inrush current should be limited to a minimum of 10 seconds after last inrush.

If these conditions are exceeded, excessive heat may cause fumes or permanent damage to the component, or at worst cause ignition.

■ Notice (Storage and Operating Condition)

1. Soldering Conditions

(1) Flux, Solder

- Rosin-based flux should be used. Do not use strong acidic flux with halide content exceeding 0.2wt% (chlorine conversion value)
- Use 63/37 solder (Sn/Pb = 63/37) or 60/40 solder (Sn/Pb = 60/40). In case of lead-free solder, use Sn-3.0Ag-0.5Cu solder

(2) Flow soldering profile

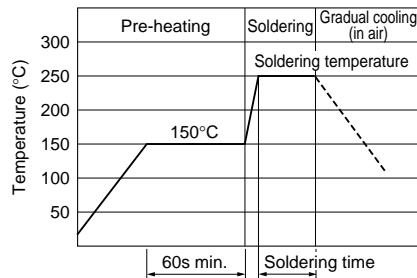

Standard profile				Limit profile		
Sn/Pb = 60/40, Sn/Pb = 63/37		Sn-3.0Ag-0.5Cu solder				
Soldering temp.	Soldering time	Soldering temp.	Soldering time	Soldering temp.	Soldering time	Cycle of flow
240-260°C	5s max.	250±2°C	4-6s	265±3°C	5s	2 times

For additional mounting methods, please contact Murata.

■ Notice (Soldering and Mounting)

Magnetic Flux Leakage

Choke coils generate small amounts of magnetic flux leakage that may adversely affect equipment operation according to component arrangement.

Testing should be completed on final assembly to ensure equipment performance is not affected.

2. Cleaning

Avoid cleaning product due to non-waterproof construction.

3. Storage and Handling Requirements

(1) Storage period

Product should be used within 12 months after receipt. Solderability should be checked if this period is exceeded.

(2) Storage conditions

Storage Temperature: -10 to 40 °C
 Relative humidity: 30 to 70%
 Avoid sudden changes in temperature and humidity. Don't keep products in corrosive gases such as sulfur chloride gas or acid, or it may cause oxidation of lead terminals resulting in poor solderability or corrosion of component windings.

(3) Handling conditions

Care should be taken when transporting or handling product to avoid excessive vibration or mechanical

■ Notice (Rating)

Coil Humming Noise

Magnetic flux generated between coil and core or between the choke coil windings creates repulsive power between the coil windings. This repulsive power causes the coil winding to vibrate and create a humming noise. The amount of hum produced by the coil is proportionate to the amount of harmonic distortion generated by the operating current. This does not influence the electrical performance of the coils, but it should be considered and tested in actual circuit application.



Part Number	Minimum Quantity (pcs.)	
	Magazine Package	Box
FKOB	-	100
PLA10	1800	1260
PLH10	1800	1260
PLY10	1800	1200
PLY17	1920	1080

⚠ Note:

1. Export Control

⟨For customers outside Japan⟩

No muRata products should be used or sold, through any channels, for use in the design, development, production, utilization, maintenance or operation of, or otherwise contribution to (1) any weapons (Weapons of Mass Destruction (nuclear, chemical or biological weapons or missiles) or conventional weapons) or goods or systems specially designed or intended for military end-use or utilization by military end-users.

⟨For customers in Japan⟩

For products which are controlled items subject to the "Foreign Exchange and Foreign Trade Law" of Japan, the export license specified by the law is required for export.

2. Please contact our sales representatives or product engineers before using the products in this catalog for the applications listed below, which require especially high reliability for the prevention of defects which might directly damage a third party's life, body or property, or when one of our products is intended for applications other than those specified in this catalog.

- | | |
|-----------------------------|--|
| ① Aircraft equipment | ② Aerospace equipment |
| ③ Undersea equipment | ④ Power plant equipment |
| ⑤ Medical equipment | ⑥ Transportation equipment (vehicles, trains, ships, etc.) |
| ⑦ Traffic signal equipment | ⑧ Disaster prevention / crime prevention equipment |
| ⑨ Data-processing equipment | ⑩ Application of similar complexity and/or reliability requirements to the applications listed above |

3. Product specifications in this catalog are as of January 2006. They are subject to change or our products in it may be discontinued without advance notice. Please check with our sales representatives or product engineers before ordering. If there are any questions, please contact our sales representatives or product engineers.

4. Please read rating and ⚠CAUTION (for storage, operating, rating, soldering, mounting and handling) in this catalog to prevent smoking and/or burning.

5. This catalog has only typical specifications because there is no space for detailed specifications. Therefore, please approve our product specifications and transact the approval sheet for product specifications before ordering.

6. Please note that unless otherwise specified, we shall assume no responsibility whatsoever for any conflict or dispute that may occur in connection with the use of our and/or a third party's intellectual property rights and other related rights in consideration of your use of our products and/or information described contained in our catalogs. In this connection, no representation shall be made to the effect that any third parties are authorized to use the rights mentioned above under licenses without our consent.

7. No ozone depleting substances (ODS) under the Montreal Protocol are used in our manufacturing process.



Murata Manufacturing Co., Ltd.

<http://www.murata.com>

Head Office
1-10-1, Higashi Kotari, Nagaokakyo-shi, Kyoto 617-8555, Japan
Phone: 81-75-951-9111

International Division
3-29-12, Shibuya, Shibuya-ku, Tokyo 150-0002, Japan
Phone: 81-3-5469-6123 Fax: 81-3-5469-6155 E-mail: intl@murata.co.jp