

# FM / AM IF system IC

## BA4237L

The BA4237L is an AM/FM IF system IC that features a selectable normal or inverted-S FM output characteristic. The FM circuit consists of a differential IF amplifier, a double-balance quadrature detector, and a weak-signal IF mute circuit.

The AM circuit consists of a local oscillator, a double-balance mixer circuit, an IF amplifier, a detector circuit, and an AGC circuit.

The IC also has a built-in LED driver circuit for an AM/FM tuning LED.

### ● Applications

AM/FM radio-cassette players  
Home stereo systems

### ● Features

- 1) Wide operating voltage range (2.7V to 12V).
- 2) Shunt AGC for improved strong-signal AM input characteristics.
- 3) Built-in FM weak-input muting to reduce noise between stations when tuning and side peaks. This mute circuit can be switched on and off externally.
- 4) Built-in driver circuit for direct drive of AM/FM tuning indicator LED.
- 5) One output for both AM and FM, allows connection to the following stage (eg. MPX) without a switch.
- 6) Pin provided for setting AM frequency characteristics. FM and AM frequency characteristics can be assigned independently to facilitate connection to MPX circuits.
- 7) Switch between AM and FM bands by switching the DC power on and off.

### ● Block diagram

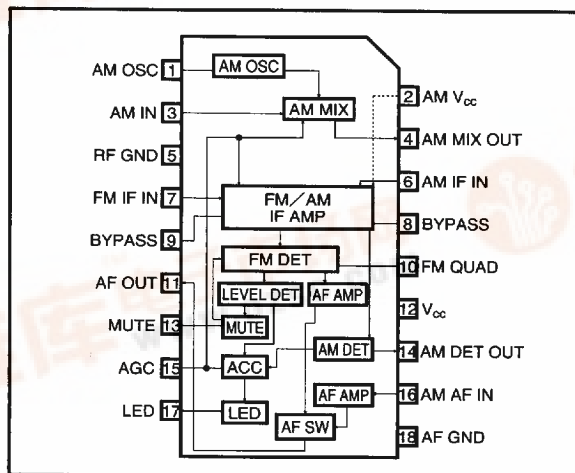

● Absolute maximum ratings (Ta = 25°C)

Parameter	Symbol	Limits	Unit
Supply voltage	V <sub>CC</sub>	16	V
Power dissipation	P <sub>d</sub>	550*	mW
Operating temperature	Topr	-25~75	°C
Storage temperature	Tstg	-55~125	°C

\* Reduced by 5.5mW for each increase in Ta of 1°C over 25°C.

● Recommended operating conditions (Ta = 25°C)

Parameter	Symbol	Min.	Typ.	Max.	Unit	Conditions
Supply voltage	V <sub>CC</sub>	2.7	6	12	V	

● Electrical characteristics (FM)

(Unless otherwise specified, Ta = 25°C, V<sub>CC</sub> = 5.25V, V<sub>IN</sub> = 100dB μV, f<sub>IN</sub> = 10.7MHz, f<sub>m</sub> = 1kHz, DEV = 30%, and Δf = ±22.5kHz)

Parameter	Symbol	Min.	Typ.	Max.	Unit.	Conditions	Measurement Circuit
Quiescent current	I <sub>Q</sub>	—	9	14	mA	MUTE OFF	Fig.1
Detector output	V <sub>OUT</sub>	70	100	130	mV	—	Fig.1
Total harmonic distortion	THD	—	0.06	0.25	%	—	Fig.1
Signal-to-noise ratio	S/N	64	70	—	dB	—	Fig.1
Limiting sensitivity	V <sub>IN (lim)</sub>	26	30	34	dB μV	V <sub>OUT</sub> =3dB	Fig.1
LED lighting sensitivity	V <sub>IN (LED)</sub>	44	49	54	dB μV	I <sub>LED</sub> =1mA	Fig.1
Noise (no input)	N	-20	-30	—	dB	Ratio with V <sub>OUT</sub> for standard input	Fig.1
Noise rejection ratio	NS	35	—	—	dB	Rejection ratio with mute on	Fig.1

● Electrical characteristics (AM)

(Unless otherwise specified, Ta = 25°C, V<sub>CC</sub> = 5.25V, V<sub>IN</sub> = 74dB μV, f<sub>IN</sub> = 1000kHz, f<sub>m</sub> = 1kHz, MOD = 30%)

Parameter	Symbol	Min.	Typ.	Max.	Unit	Conditions	Measurement Circuit
Detector output	V <sub>O</sub>	70	110	140	mV	—	Fig.1
Total harmonic distortion	THD	—	0.8	2.5	%	—	Fig.1
Signal-to-noise ratio	S/N	44	52	—	dB	—	Fig.1
Maximum sensitivity	V <sub>IN Max.</sub>	5	8	13	dB μV	V <sub>OUT</sub> =10mVrms	Fig.1
LED lighting sensitivity	V <sub>IN (LED)</sub>	18	23	28	dB μV	I <sub>LED</sub> =1mA	Fig.1

● Measurement circuit

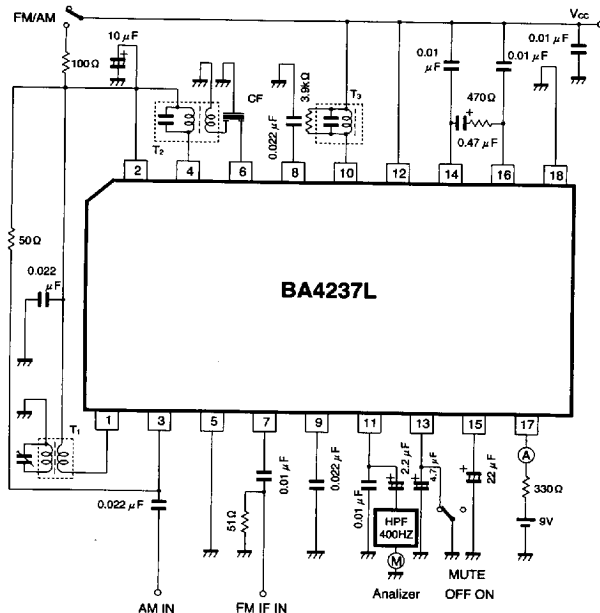

T<sub>1</sub> : AM OSC 2157-2239-295(SUMIDA)  
 T<sub>2</sub> : AM IFT 2150-2173-157(SUMIDA)  
 T<sub>3</sub> : FM DET 2153-409-090(SUMIDA)  
 CF : AM CFM2-455B(TOKO)

Fig. 1

● Coil specifications

- (1) T<sub>1</sub> : AM OSC 2157-2239-295 (SUMIDA)

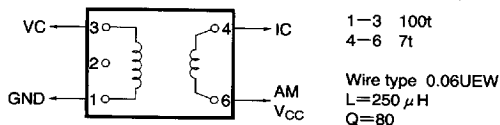

Fig. 2

- (2) T<sub>2</sub> : AM IFT (455kHz) 2150-2173-157 (SUMIDA)

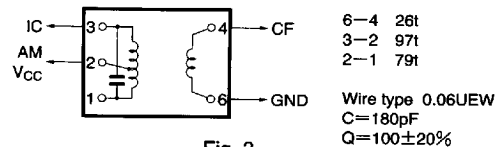

Fig. 3

- (3) T<sub>3</sub> : FM DET (10.7kHz) 2153-409-090 (SUMIDA)

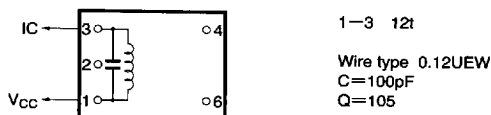

Fig. 4

● Operation notes

- (1) Leakage from the local AM oscillator or other noise input to the AM IF input (pin 6) can cause the LED to light when it shouldn't, and reduce the sensitivity. To prevent this, the track connecting the output of the AM ceramic oscillator to the IF input (pin 6) should be as short as possible.
- (2) Make the earth point for the FM detector coil the output GND or V<sub>cc</sub>. If the input GND is used, feedback may cause unstable circuit operation.
- (3) When observing the FM "S" detector characteristics using a sweep generator, switch the muting off. If the muting is left on, the muting time constant will cause the "S" curve to be displayed incorrectly.
- (4) The amount of reduction caused by the FM muting varies with the front-end noise.

7828999 0018946 89T

● Circuit operation

(1) Circuit construction

The BA4237L is an AM/FM IF system IC.

The FM circuit consists of a differential IF amplifier, a double-balance quadrature detector, and a weak-signal audio mute circuit.

The AM circuit consists of a local oscillator, a double-balance mixer circuit, an IF amplifier, a detector circuit, and an AGC circuit.

The IC also has a built-in LED driver circuit for band indication.

(2) Pin connections

- ① AM local oscillator : connect to the secondary side of the oscillator coil
- ② AM V<sub>cc</sub> : AM/FM band switch
- ③ AM signal input : connect to the AM antenna secondary

- ④ AM mixer output : connect to the AM IFT
- ⑤ GND : high-frequency ground
- ⑥ AM IF input : connect to AM ceramic filter
- ⑦ FM IF input : connect to FM ceramic filter
- ⑧ IF amplifier bypass : connect to bypass capacitor
- ⑨ IF amplifier bypass : connect to bypass capacitor
- ⑩ FM phase-shift coil : connect to phase-shift coil
- ⑪ Audio output : connect to next stage (MPX etc.)
- ⑫ V<sub>cc</sub> : connect to power supply
- ⑬ FM mute : connect to a capacitor
- ⑭ AM detector output : connect to CR filter
- ⑮ AGC : connect to a capacitor
- ⑯ AM audio input : connect to CR filter
- ⑰ Tuning LED : connect to an LED
- ⑱ GND : low frequency ground

(3) Operation

● AM/FM IF amplifier

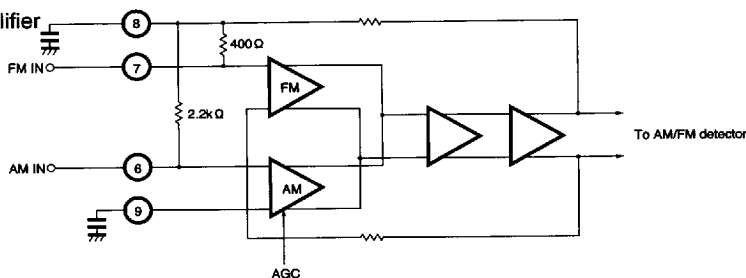

Fig. 5 The AM / FM IF amplifier is a three-stage differential amplifier.

The second and third stages are used for both AM and FM. When the IC is switched between the AM and FM bands, the constant-current supply is switched, and one of the independent first-stage amplifier circuits (AM or FM) is activated.

The gain of this stage is 50dB for both AM and FM. The AM circuit uses AGC at the first stage. If the amplifier is cutoff by the AGC, the DC balance of the circuit will be lost, so the circuit is designed in such a way that the amplifier is not completely cutoff. This suppresses distortion when the amplifier is cutoff, and enables quick transfer to RF stage AGC operation.

The FM input impedance is set by an on-chip resistor, and is approximately 400Ω. It is directly connected to a 330Ω ceramic filter.

The AM input impedance is approximately 2.2kΩ and is directly connected to a 2kΩ or 3kΩ ceramic filter.

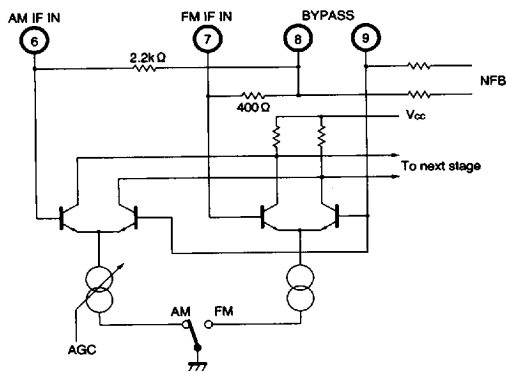

Fig. 6

● FM detector circuit

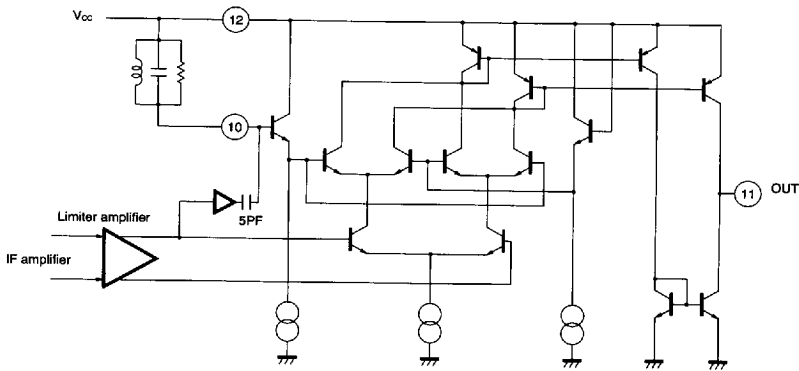

Fig. 7

The FM detector circuit uses a quadrature detector system. The IF-amplified signal passes through a limiter amplifier, with gain of approximately 12dB, to the detector input. The output impedance of the limiter amplifier has been made as small as possible to ensure that the maximum amplitude and 90° phase shift conditions for input to the detector do not go out of synchronization. To improve the linearity of the 90° phase-shifted signal, there is a phase-shift buffer on the phase-shift output side. The "S" characteristic of the FM output is compatible with -90° phase-shifted lower heterodyne AFC.

● AM mixer circuit

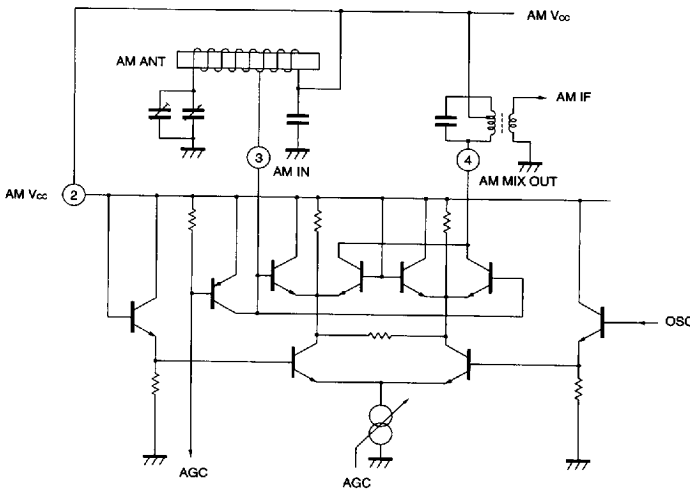

Fig. 8

The AM mixer uses a double-balance circuit, and has been designed to minimize leakage from the local oscillator. The mixer input passes through the AM antenna coil and is biased by the AM Vcc. For medium to strong electric fields, the AGC operates to lower the mixer conversion gain, and the input shunt AGC provides excellent strong-signal input characteristics in the case of strong electric fields.

● AM local oscillator circuit

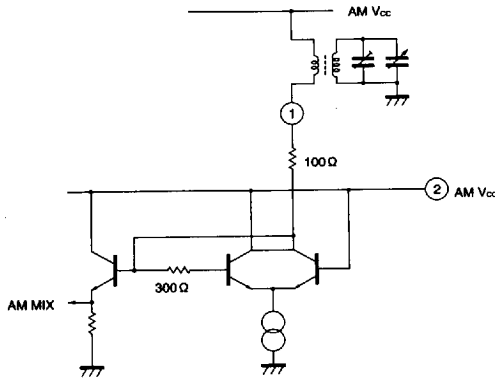

Fig. 9

The AM oscillator circuit uses a positive feedback loop from a differential amplifier to drive an emitter follower buffer circuit.

This buffer circuit improves the frequency deviation caused by the input signal level.

To allow oscillation up to the SW band, a 300Ω feedback resistor is used, and a 100Ω resistor is connected in series with the tank circuit to improve the startup characteristics.

● AM AGC circuit

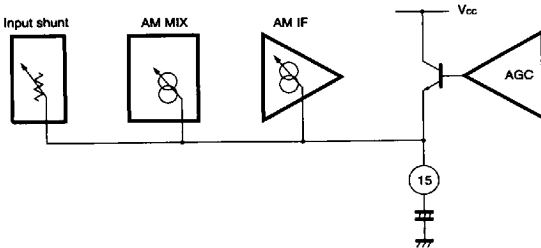

Fig. 11

AGC is applied to the mixer circuit and the IF circuit. The AGC reduces the mixer and IF circuit current according to the DC level of the detector output, and reduces the gain to control the output at a fixed level.

In addition, a shunt circuit is included as a countermeasure against strong input signals to prevent degradation due to distortion.

● AM detector circuit

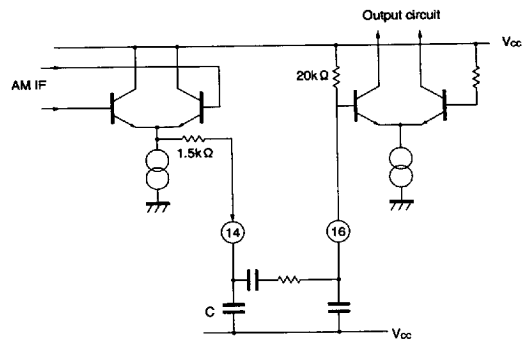

Fig. 10

The AM detector circuit is an envelope detector formed by an emitter follower, and handles the signal from the AM IF as a differential to improve the detection efficiency.

● AM/FM tuning LED drive circuit

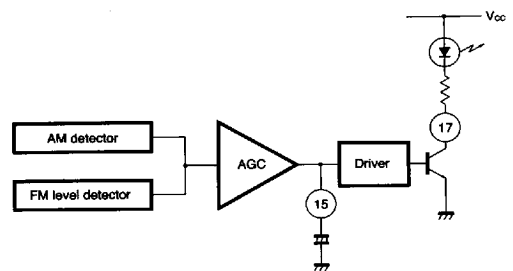

Fig. 12

An AM/FM tuning indicator LED can be driven directly by the IC. The circuit senses the IF levels of both AM and FM, amplifies the signal with the AGC amplifier and uses the voltage on pin 15 to drive the tuning LED. As only the IF is detected, the tuning band is set by the bands of the ceramic filters connected to each IF input.

● AM/FM detector output circuit

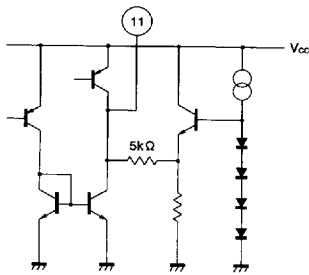

Fig. 13

● External components

(1) AM local oscillator circuit (pin 1)

When the secondary of the AM local oscillator coil is connected to the IC, connection of a decoupling CR circuit will reduce oscillator leakage. Take the power from pin 2. If the oscillation of the circuit is unstable in the SW band due to lower oscillation coil Q, connect a resistor between the oscillation coil and the IC to stabilize the oscillation. The drop in voltage due to the resistor connector to pin 1 should be within 0.2V of the voltage on pin 2. Set the level of the oscillation voltage at pin 1 to between 80mV<sub>rms</sub> to 300mV<sub>rms</sub>. Oscillation voltage characteristics are given in Fig. 15.

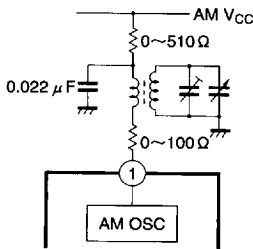

Fig. 14

One pin is used for both outputs, and the AM / FM switching is done on the IC. The output impedance is about 5kΩ, and the DC output voltage is about 2V.

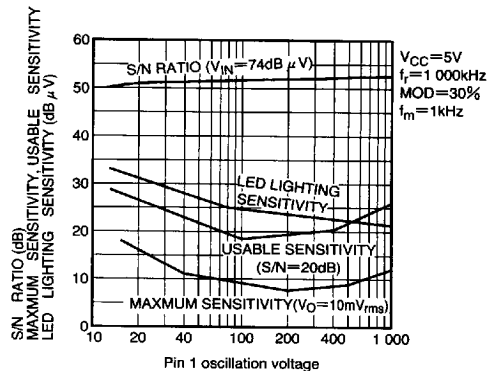

Fig. 15

(2) AM power supply filter

The AM V<sub>cc</sub> is switched on and off to switch between the AM/FM bands. When power is connected to pin 2, the AM band is selected.

It is possible to reduce the switching noise generated when switching between AM and FM by connecting a CR filter. The drop in voltage due to the resistor should be within 0.5V of the voltage on pin 12.

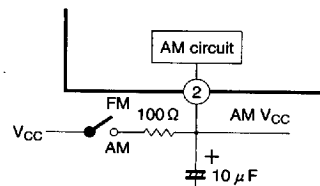

Fig. 16

● External components

(3) AM RF input (pin 3)

The AM RF input pin is the  $V_{CC}$  bias. Make the DC voltage on pin 3 the same as the voltage on pin 2. If there is a voltage drop, leakage from the local oscillator to the mixer output will be large and result in spurious signals.

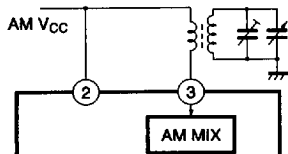

Fig. 17

(4) AM mixer output (pin 4)

For the AM mixer output, use an IFT coil that is matched to the ceramic filter. Take the IFT bias from pin 2, and make it the same potential as pin 4. Also, connect the coil as close as possible to pin 4.

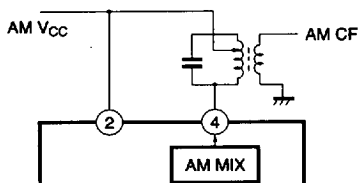

Fig. 18

(5) IF input (pin 6)

The input impedance of the AM IF input is approximately  $2.2k\Omega$ , so it can be directly connected to a ceramic filter with impedance in the range  $1.8k\Omega$  to  $3k\Omega$ . If local oscillator leakage or other external noise enters pin 6, the tuning LED may light when it shouldn't or cause loss of sensitivity. To prevent this, connect the ceramic filter as close as possible to pin 6. Connect the ceramic filter earth to the pin 5 GND.

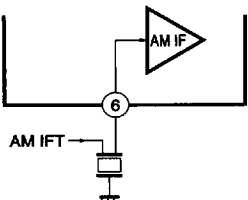

Fig. 19

(6) IF input (pin 7)

The input impedance of the FM IF input is approximately  $400\Omega$ , so it can be directly connected to a ceramic filter with an impedance of  $300\Omega$ . Connect the ceramic filter as close as possible to pin 7, in the same way as for the AM circuit, and earth the ceramic to the pin 5 GND.

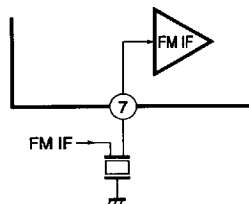

Fig. 20

(7) IF amplifier bypass capacitors (pins 8 and 9)

Connect pins 8 and 9 to the pin 5 GND using capacitors that have good high-frequency characteristics. If the capacitance values are too low, AM circuit operation will be unstable. We recommend semiconductor capacitors of  $0.022\mu F$ .

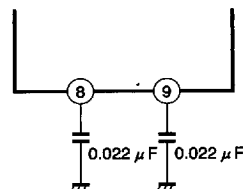

Fig. 21

(8) FM quadrature phase-shifting coil (pin 10)

R is the damping resistor for the phase-shifting coil. Large values for R will give larger detector output, but will also increase the distortion. Small values for R will improve the distortion, but the output will be smaller, and the S/N ratio larger. Characteristics for different values of R are given in Fig. 23.

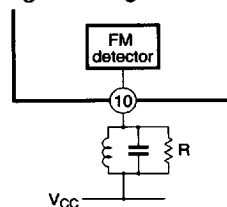

Fig. 22



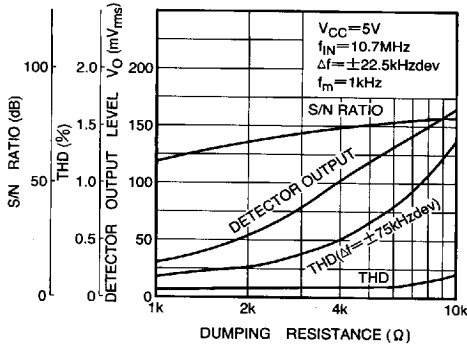

Fig. 23

Connect the phase-shifting coil earth point to either the pin 18 GND, or VCC. If you connect it to the pin 5 GND, feedback may cause the circuit to become unstable. Set the pin 10 bias to the same potential as pin 12.

(9) Detector output LPF (pin 11)

In the case of AM, the signal has already been high cut by the audio filter connected to pins 14 to 16 at the previous stage, so this low-pass filter has almost no effect. In the case of FM, the value of C is set by the next-stage circuit. In the case of monaural operation, for de-emphasis, the value of C should be 0.01 μF (50 μs) or 0.015 μF (75 μs), (the pin 11 output impedance is 5k Ω).

In the case of stereo, an FM MPX is connected as the following stage, so C should be in the range 100pF to 1000pF. If nothing is connected, IF feedback will be applied to the previous stage, and may cause circuit instability.

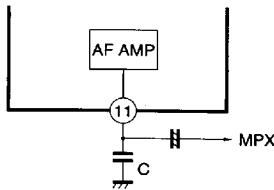

Fig. 24

(10) FM audio muting (pin 13)

FM muting can be switched on and off. To switch muting off, pull pin 13 to GND. Note, that if the value of C is too small, full muting may not occur for de-tuning. When R is open circuit (infinity), hard muting will be applied roughly in synchronous with the tuning injector.

With small values of R, soft muting will occur, but the amount of attenuation will vary with the front-end noise. The muting characteristic curves for a single IF are shown in Fig. 26.

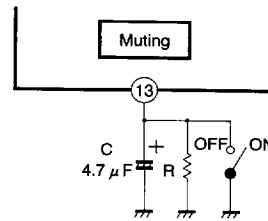

Fig. 25

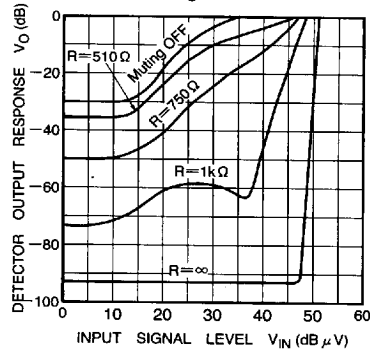

Fig. 26

Switch the muting off to observe the "S" curve on a sweep generator. If it is left on, you will not be able to view the correct "S" curve because of the muting time constant.

(11) AM audio filter (pins 14 and 16)

It is possible to construct an AM audio filter between pins 14 and 16.  $R_1$  and  $C_1$  form a low-pass filter, and  $C_1$  also serves as the AM detector low-pass filter.  $C_2$  and  $R_3$  form a high-pass filter. If the value of  $C_2$  is too large, the audio will be temporarily be cutoff when switching between AM/FM, so use a capacitor of  $1 \mu F$  or less.  $R_2$  and  $C_3$  form a low-pass filter.  $R_2$  and  $R_3$  attenuate the audio output. Fig. 28 shows the characteristics for different component values.

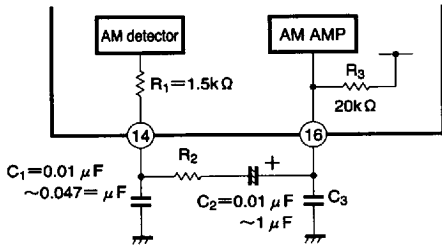

Fig. 27

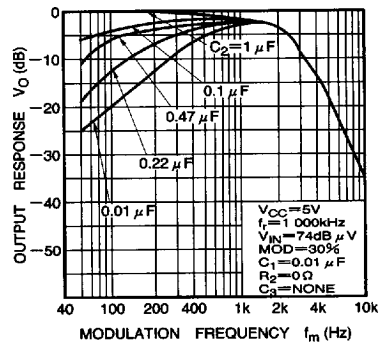

Fig. 28-2

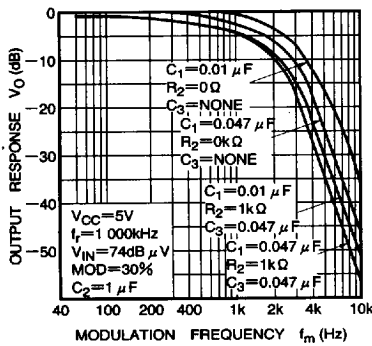

Fig. 28-1

● External components

(12) AM AGC time constant (pin 15)

If the value for C in the AGC low-pass filter is small, distortion will worsen at low modulation frequencies. If C is large, the response of the AGC circuit will be slower. Characteristics for different values of C are given in Fig. 30.

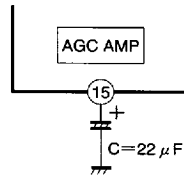

Fig. 29

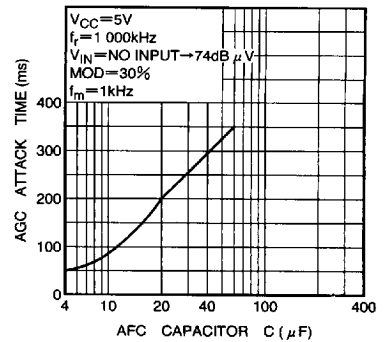
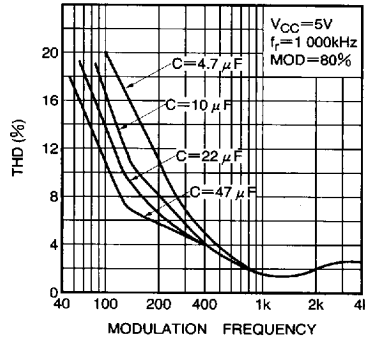
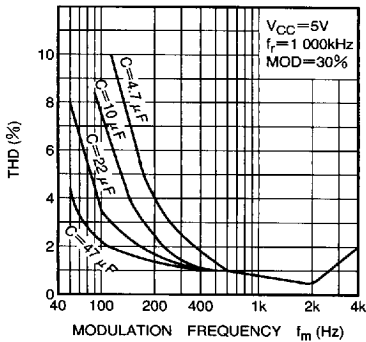

Fig. 30

(13) Tuning injector (pin 17)

The current flowing into pin 17 is limited by the resistor R. The value of the current is obtained from :  $(+B-2) / R$ . The value of the current must not exceed 15mA. The maximum voltage that can be applied to pin 17 is 12V.

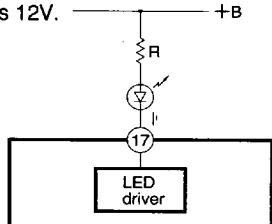

Fig. 31

(14) FM AFC circuit

By using the DC output voltage from the pin 11 detector output, it is possible to apply AFC to the circuit. A circuit example using a BA4424N front end is given in Fig. 33.

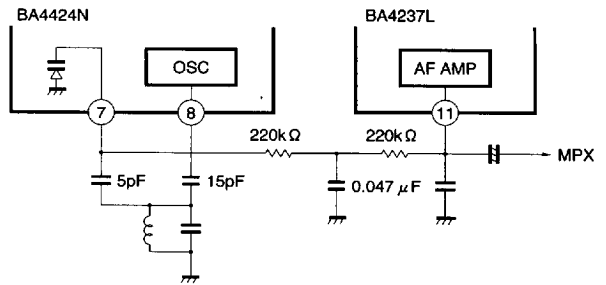

Fig. 32

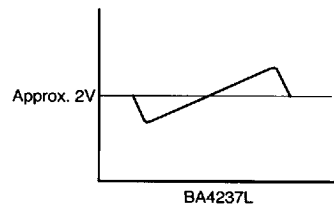

Fig. 33

● Electrical characteristic curves

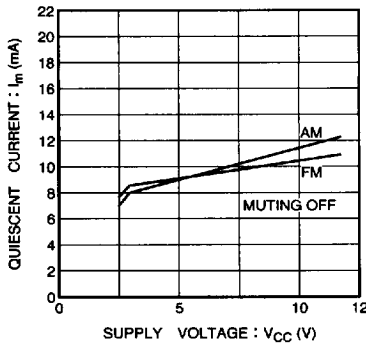

Fig. 34 Quiescent current vs. supply voltage

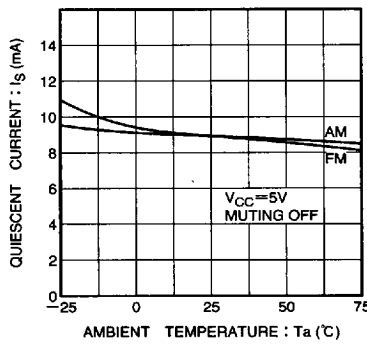

Fig. 35 Quiescent current vs. ambient temperature

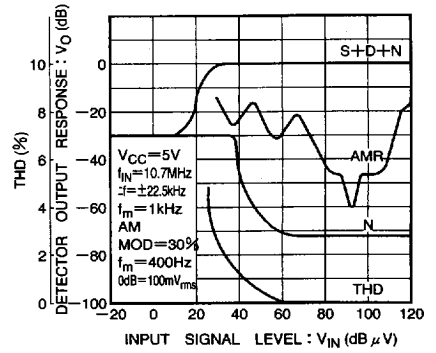

Fig. 36 FM THD and detector output response vs. input signal

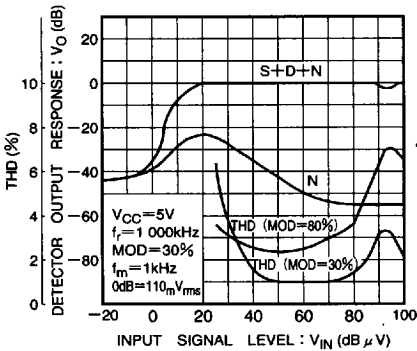

Fig. 37 FM THD and detector output response vs. input signal level

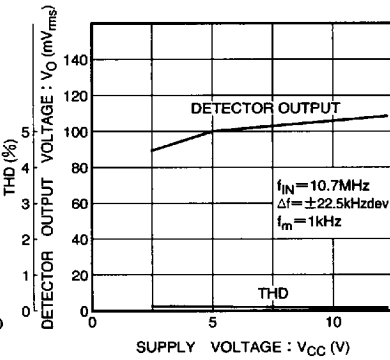

Fig. 38 FM THD and detector output voltage vs. supply voltage

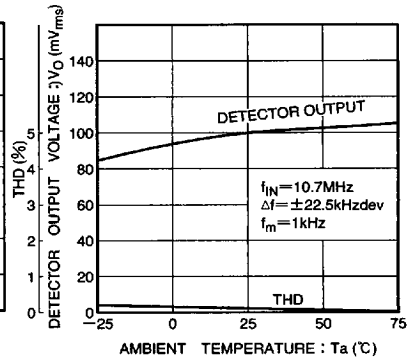

Fig. 39 FM THD and detector output voltage vs. ambient temperature

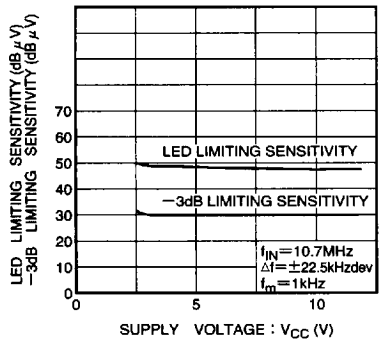

Fig. 40 FM LED on sensitivity and -3dB limiting sensitivity vs. supply voltage

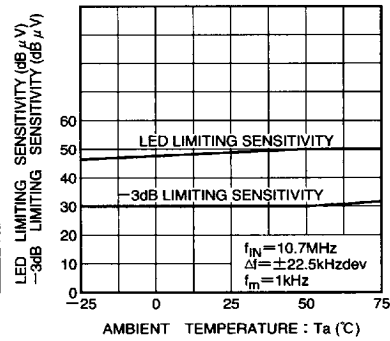

Fig. 41 FM LED on sensitivity and -3dB limiting sensitivity vs. ambient temperature

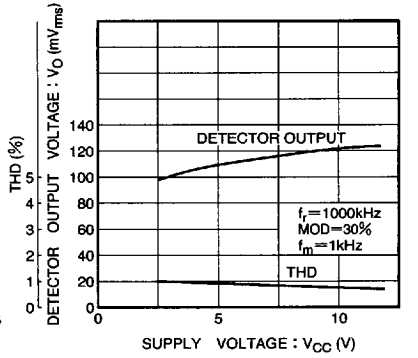

Fig. 42 AM THD and detector output voltage vs. supply voltage

● Electrical characteristic curves

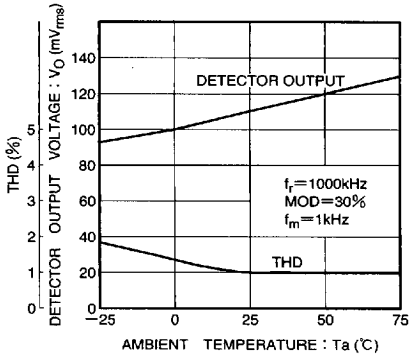

Fig. 43 AM THD and detector output voltage vs. ambient temperature

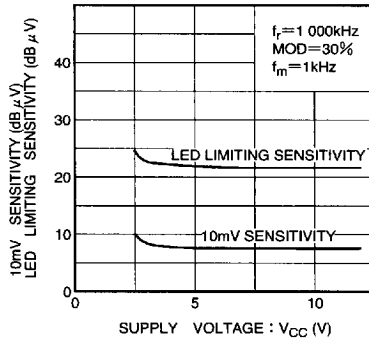

Fig. 44 AM 10mV sensitivity and LED on sensitivity vs. supply voltage

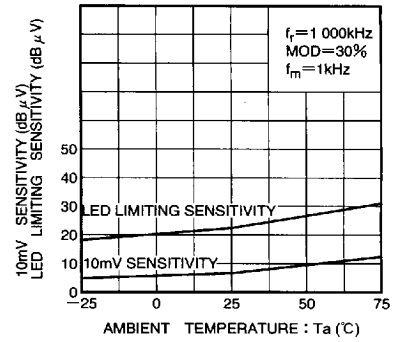

Fig. 45 AM 10mV sensitivity and LED on sensitivity vs. ambient temperature

● External dimensions (Unit: mm)

